

# KTL180

Fiber contrast sensor

**SICK**  
Sensor Intelligence.



## Described product

KTL180

## Manufacturer

SICK AG  
Erwin-Sick-Str. 1  
79183 Waldkirch  
Germany

## Legal information

This work is protected by copyright. Any rights derived from the copyright shall be reserved for SICK AG. Reproduction of this document or parts of this document is only permissible within the limits of the legal determination of Copyright Law. Any modification, abridgment or translation of this document is prohibited without the express written permission of SICK AG.

The trademarks stated in this document are the property of their respective owner.

© SICK AG. All rights reserved.

## Original document

This document is an original document of SICK AG.



## Contents

<b>About this document.....</b>	<b>6</b>
1 Information on the operating instructions.....	6
2 Scope.....	6
3 Explanation of symbols.....	6
4 Further information.....	7
5 Customer service.....	7
<b>Safety information.....</b>	<b>8</b>
1 Intended use.....	8
2 Improper use.....	8
3 Limitation of liability.....	8
4 Hazard warnings and operational safety.....	9
4.1 Eye safety.....	9
5 Repair.....	9
<b>Product description.....</b>	<b>10</b>
1 Product ID.....	10
1.1 Type label.....	10
2 Product features and functions.....	11
2.1 Device view.....	11
2.2 Product characteristics.....	11
<b>Mounting.....</b>	<b>12</b>
1 Scope of delivery.....	12
2 Mounting requirements.....	12
3 Connecting fibers.....	12
3.1 Use fibers with thin end sleeves.....	13
4 Mounting the device.....	13
5 Expanding evaluation unit.....	14
5.1 Combination with other sensors.....	14
6 Aligning fibers.....	15
<b>Electrical installation.....</b>	<b>16</b>
1 Notes on electrical installation.....	16
2 Pin assignment of the connections.....	17
3 Wiring the interfaces.....	17
3.1 Wiring the digital input.....	18
3.2 Wiring the digital outputs.....	18
4 Connecting the supply voltage.....	19
<b>Commissioning.....</b>	<b>20</b>
1 Simplified illustration.....	20
<b>Operation.....</b>	<b>21</b>
1 Operating elements.....	21

en

en

2	Navigation tree, general.....	22
3	Navigation tree, Pro level.....	23
4	List of abbreviations (type-dependent).....	24
5	Defaults.....	24
5.1	Teach-in.....	24
5.2	Adjusting switching threshold.....	26
5.3	Adjusting the switching logic (light/dark).....	26
5.4	Adjusting the switching sensitivity.....	27
5.5	Adjusting time level.....	28
5.6	Selecting canal.....	29
5.7	Activating or deactivating the button lock.....	29
6	Pro level (advanced settings).....	29
6.1	Adjusting response time.....	29
6.2	Setting display value to zero.....	30
6.3	Selecting display settings.....	31
6.4	Activating energy-saving mode.....	31
6.5	Rotating the display.....	32
6.6	Configuring input.....	32
6.7	Adjusting copy mode.....	33
6.8	Setting master teach-in.....	34
6.9	Setting synchronization.....	35
6.10	Setting continuous threshold adaptation.....	36
6.11	Setting receiver amplification.....	36
6.12	Setting pushbutton lock.....	37
6.13	Storing or loading a parameter set (job).....	38
6.14	Displaying firmware version.....	38
7	Other indicators and functions.....	39
8	Resetting the device (factory setting).....	39
	<b>Troubleshooting.....</b>	<b>41</b>
1	Possible errors during commissioning.....	41
2	Possible errors during operation.....	41
	<b>Maintenance.....</b>	<b>42</b>
1	Maintenance.....	42
2	Cleaning the device.....	42
	<b>Decommissioning.....</b>	<b>44</b>
1	Disassembly and disposal.....	44
2	Returning devices.....	44
	<b>Technical data.....</b>	<b>45</b>
1	General data.....	45
2	Dimensional drawings.....	46
	<b>Accessories.....</b>	<b>48</b>

<b>Annex.....</b>	<b>49</b>
1 Conformities and certificates.....	49
2 Certification according to UL60947-5-2.....	49

en

## About this document

### 1 Information on the operating instructions

These operating instructions provide important information on how to use devices from SICK AG.

Prerequisites for safe work are:

- Compliance with all safety notes and handling instructions supplied
- Compliance with local work safety regulations and general safety regulations for device applications

The operating instructions are intended to be used by qualified personnel and electrical specialists.



---

#### NOTE

Read these operating instructions carefully before starting any work on the device, in order to familiarize yourself with the device and its functions.

---

The instructions constitute an integral part of the product and are to be stored in the immediate vicinity of the device so they remain accessible to staff at all times. Should the device be passed on to a third party, these operating instructions should be handed over with it.

These operating instructions do not provide information on operating the machine in which the device is integrated. For information about this, refer to the operating instructions of the specific machine.

### 2 Scope

These operating instructions serve to incorporate the device into a customer system. Instructions are given in stages for all actions required.

These instructions apply to all listed device variants of the product.

Available device variants are listed on the online product page.

► [www.sick.com/KTL180](http://www.sick.com/KTL180)

Commissioning is described using one particular device variant as an example.

#### Simplified device designation in the document

In the following, the sensor is referred to in simplified form as “KTL180” or “device”.

### 3 Explanation of symbols

Warnings and important information in this document are labeled with symbols. The warnings are introduced by signal words that indicate the extent of the danger. These warnings must be observed at all times and care must be taken to avoid accidents, personal injury, and material damage.



---

#### DANGER

... indicates a situation of imminent danger, which will lead to a fatality or serious injuries if not prevented.

---

**WARNING**

... indicates a potentially dangerous situation, which may lead to a fatality or serious injuries if not prevented.

**CAUTION**

... indicates a potentially dangerous situation, which may lead to minor/slight injuries if not prevented.

**NOTICE**

... indicates a potentially harmful situation, which may lead to material damage if not prevented.

**NOTE**

... highlights useful tips and recommendations as well as information for efficient and trouble-free operation.

## 4 Further information

en

**NOTE**

All the documentation available for the device can be found on the online product page at:

▶ [www.sick.com/KTL180](http://www.sick.com/KTL180)

The following information is available for download from this page:

- Type-specific online data sheets for device variants, containing technical data and dimensional drawings
- EU declaration of conformity for the product family
- Dimensional drawings and 3D CAD dimension models in various electronic formats
- These operating instructions, available in English and German, and in other languages if necessary
- Other publications related to the devices described here
- Publications dealing with accessories

## 5 Customer service

If you require any technical information, our customer service department will be happy to help. To find your agency, see the final page of this document.

**NOTE**

Before calling, make a note of all type label data such as type code, serial number, etc., to ensure faster processing.

## Safety information

### 1 Intended use

The KTL180 fiber contrast sensor is an opto-electronic sensor for the optical, non-contact detection of contrasts.

A fiber contrast sensor is designed for mounting and may only be operated according to its intended function. For this reason, it is not equipped with direct safety devices.

The system designer must provide measures to ensure the safety of persons and systems in accordance with the legal guidelines.

SICK AG assumes no liability for losses or damage arising from the use of the product, either directly or indirectly. This applies in particular to use of the product that does not conform to its intended purpose and is not described in this documentation.

### 2 Improper use

- The device does not constitute a safety-relevant device according to the EC Machinery Directive (2006/42/EC).
- The device must not be used in explosion-hazardous areas.
- Any other use that is not described as intended use is prohibited.
- Any use of accessories not specifically approved by SICK AG is at your own risk.

The device is not suitable for the following applications (this list is not exhaustive):

- As a safety device to protect persons, their hands, or other body parts
- Underwater
- In explosion-hazardous areas
- Outdoors, without additional protection



#### NOTICE

##### **Danger due to improper use!**

Any improper use can result in dangerous situations.

Therefore, observe the following information:

- ▶ The device should be used only in line with intended use specifications.
- ▶ All information in these operating instructions must be strictly complied with.

### 3 Limitation of liability

Applicable standards and regulations, the latest state of technological development, and our many years of knowledge and experience have all been taken into account when assembling the data and information contained in these operating instructions. The manufacturer accepts no liability for damage caused by:

- Failure to observe the operating instructions
- Improper use
- Use by untrained personnel
- Unauthorized conversions
- Technical modifications
- Use of unauthorized spare parts, wear and tear parts, and accessories

With special variants, where optional extras have been ordered, or owing to the latest technical changes, the actual scope of delivery may vary from the features and illustrations shown here.



## 4 Hazard warnings and operational safety

Please observe the safety notes and the warnings listed here and in other chapters of these operating instructions to reduce the possibility of risks to health and avoid dangerous situations.

### 4.1 Eye safety



#### CAUTION

The device is equipped with LEDs. The device meets the criteria of risk group 2 according to IEC 62471:2006. The device emits potentially dangerous optical radiation.

Do not look into the lamp for extended periods of time during operation. Can be damaging to the eyes.

---

## 5 Repair

The product is a replacement device. The device is not intended to be repaired. Interference with or modifications to the device on the part of the customer will invalidate any warranty claims against SICK AG.

en

## Product description

### 1 Product ID

#### 1.1 Type label

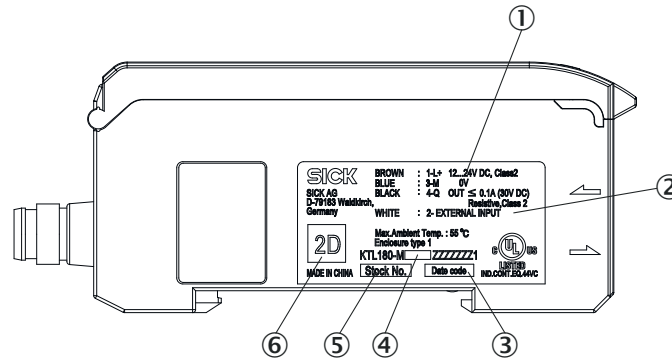

Figure 1: KTL180 type label

- ① Pin assignment
- ② Electrical data and environmental data
- ③ Date of manufacture
- ④ Device type number
- ⑤ Part number
- ⑥ 2D code

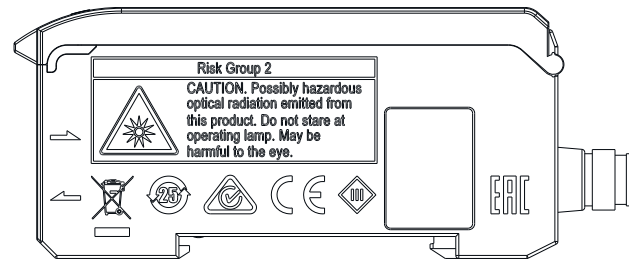

Figure 2: KTL180 rear with logos

en

## 2 Product features and functions

### 2.1 Device view



- ① Connection
- ② Pushbuttons
- ③ Display
- ④ Fiber interlocking
- ⑤ Fiber opening

en

### 2.2 Product characteristics

The KTL180 features the following features and fields of application:

#### Features

- Multi-functional 7-segment display
- 32 kHz switching frequency
- High dynamic range
- Job save for easy format change
- 1-point, 2-point and dynamic teach-in
- Bus capability
- Wide range of different fiber cables

#### Fields of application

- All applications for which contrasts make up the decisive characteristic
- Application with small installation space
- Printing mark detection
- Print control
- Tube filling
- Label cutting
- Splice detection
- Wafer production

## Mounting

### 1 Scope of delivery

- Device in the version ordered
- Quickstart
- Safety notes

The fibers are not included in the scope of delivery.

### 2 Mounting requirements

- Typical space requirement for the device, see type-specific dimensional drawing, see "Technical data", page 45.
- Comply with technical data, such as the permitted ambient conditions for operation of the device (e.g., temperature range, EMC interference emissions, ground potential).
- To prevent condensation, avoid exposing the device to rapid changes in temperature.
- Protect the device from direct sunlight.
- Shock and vibration-free mounting.

### 3 Connecting fibers

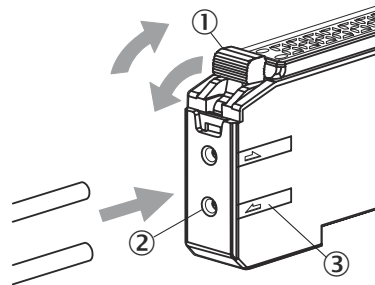

Figure 3: Connecting fibers

- ① Fiber interlocking
- ② Fiber opening
- ③ Sender/receiver designation

1. Open fiber interlocking ①.
2. Insert the fibers into the provided openings ② as far as they will go, about 15 mm. Check the sender/receiver designation ③ while you are doing this.
3. Close the optical fiber interlocking.



#### NOTICE

When using a pushbutton variant with coaxial fiber arrangement, connect the core fiber or fiber marked in white to the sender. Connect the second fiber to the receiver.

### 3.1 Use fibers with thin end sleeves

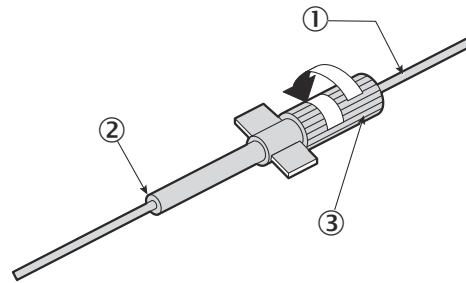

Figure 4: Fiber with thin end sleeve

- ① Fiber with thin end sleeve
- ② Separation position
- ③ Adjustment cap

1. Completely rotate the adjustment cap ③ counter-clockwise and guide the fibers in ①.
2. Rotate the adjustment cap ③ clockwise to close it.
3. Disconnect excess fibers.

en

## 4 Mounting the device

### Mounting the device on mounting rail

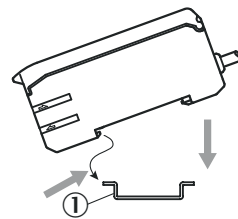

Figure 5: Installation on mounting rail

- ① Mounting rail

1. Clip the device into the mounting rail ①.
2. Press down from above to lock.

## 5 Expanding evaluation unit

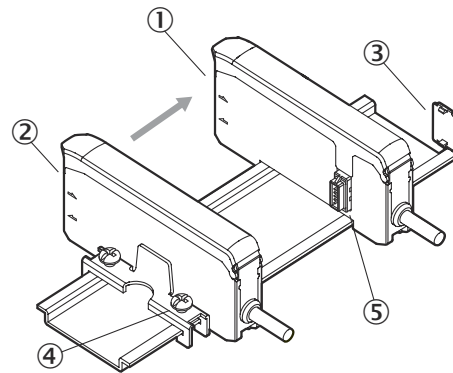

Figure 6: Expanding base unit

- ① Expansion unit
- ② Base unit
- ③ Protective cover for bus female contact
- ④ End piece (accessory)
- ⑤ Bus male connector

1. Mount the ② base unit to the mounting rail.
2. Mount the ④ end piece to the mounting rail directly behind the base unit to prevent slipping. (Optional)
3. Close the female contact of the extension unit with protective cover.③.
4. Mount the expansion unit ① to the mounting rail.
5. Push expansion unit to base unit ② until the female contact of the basic unit and bus male connector ⑤ of the expansion unit have a fixed contact.

### 5.1 Combination with other sensors

The KTL180 can be combined with other sensors on the same bus. The following table lists other suitable products:

Product family	Sensor type
WLL180T	Fiber optic sensor
AOD1	Amplifier for OD1, OD5000, OL1 distance sensors

The following restrictions must be considered for the combination:

- If KTL180 units are combined with WLL180T units, all WLL180T units used must be mounted on the bus left of all used KTL180 units.
- If KTL180 units are combined with AOD1 units, all KTL180 units used must be mounted on the bus left of all used AOD1 units.



#### NOTE

If these combination orders are not followed, unspecific temporal behavior of the measured value logging could occur.



#### NOTE

When combining sensors on the bus, there are additional restrictions concerning usable functions, see "Adjusting copy mode", page 33 and see "Setting master teach-in", page 34.

## 6 Aligning fibers

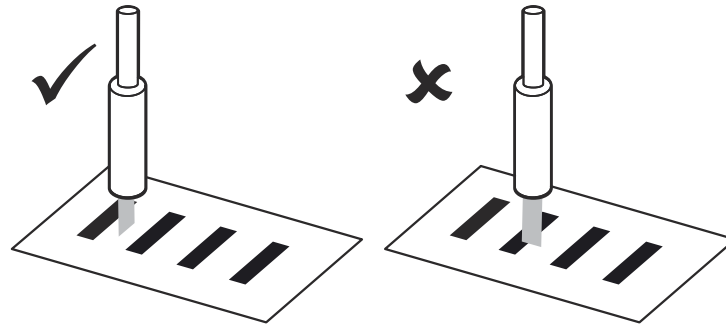

Figure 7: Align fibers with square light spot

With fibers with square light spots, the light spot must be aligned lengthwise to the mark. Alignment does not play a role for fibers with round light spots.

en

## Electrical installation

### 1 Notes on electrical installation

**NOTICE****Radio interference when used in residential areas**

The device complies with the Radio Safety Requirements (EMC) for the industrial sector (Radio Safety Class A). It may cause radio interference if used in a residential area.

**NOTICE****Equipment damage due to incorrect supply voltage!**

An incorrect supply voltage may result in damage to the equipment.

- Only operate the device with safety/protective extra-low voltage (SELV/PELV).
- The sensor is a device of protection class III.

**NOTICE****Equipment damage due to incorrect supply voltage!**

An incorrect supply voltage may result in damage to the equipment.

- Only operate the device with an LPS (limited power source) in accordance with IEC 62368-1 or an NEC Class 2 power supply unit.

**NOTICE****Equipment damage or unpredictable operation due to working with live parts!**

Working with live parts may result in unpredictable operation.

- Only carry out wiring work when the power is off.
- Only connect and disconnect electrical connections when the power is off.

- **The electrical installation must only be performed by electrically qualified personnel.**
- **Standard safety requirements must be observed when working on electrical systems!**
- Only switch on the supply voltage for the device when the connection tasks have been completed and the wiring has been thoroughly checked.
- When using extension cables with open ends, ensure that bare wire ends do not come into contact with each other (risk of short-circuit when supply voltage is switched on!). Wires must be appropriately insulated from each other.
- Wire cross-sections in the supply cable from the user's power system must be selected in accordance with the applicable standards.
- Only operate the device with an LPS (limited power source) in accordance with IEC 62368-1 or an NEC Class 2 power supply unit.
- All circuits connected to the device must be designed as SELV/PELV circuits.
- Operation in short-circuit protected network at max. 8 A.



**NOTE****Layout of data cables**

- Use shielded data cables with twisted-pair wires.
- Implement the shielding design correctly and completely.
- To avoid interference, e.g., from switching power supplies, motors, clocked drives, and contactors, always use cables and layouts that are suitable for EMC.
- Do not lay cables over long distances in parallel with voltage supply cables and motor cables in cable channels.

The IP enclosure rating for the device is only achieved under the following conditions:

- The cables plugged into the connections are screwed tight.

If these instructions are not complied with, the IP enclosure rating for the device is not guaranteed!

## 2 Pin assignment of the connections

### Overview of pin assignment

Table 1: M8 male connector, 4-pin

	Function
1	L+
2	MFin
3	M
4	Q

Table 2: M12 pigtail, 5-pin

	Function
1	L+
2	MFin
3	M
4	Q <sub>1</sub>
5	Q <sub>2</sub>

### Encoder

L+ = Supply voltage

MFin = multifunctional input

M = Ground

Q = Switching output

## 3 Wiring the interfaces

**NOTE**

When using the M12, 5-pin variants, in addition to Q<sub>1</sub>, Q<sub>2</sub> is always activated and assigned a switching threshold value of 14 digits as per the factory settings.

In applications in which the contrast value of marks or backgrounds is < 14 digits, this can cause an additional switching event to Q<sub>2</sub> to be displayed when transitioning from the mark to the background.

Should this lead to problems, PIN5 may not be connected or is ignored in the control.

### 3.1 Wiring the digital input

The digital input can be used to start a teach-in procedure or to select a device operating mode.

Voltage level at the input starts the corresponding function of the device.

#### Electrical values

see "General data", page 45

#### Input, teach-in (tch)

PNP: Teach = HIGH; Run = LOW

NPN: Teach = LOW; Run = HIGH

#### Input, all-teach-in (Atch), only for bus variants

PNP: Teach = HIGH; Run = LOW

NPN: Teach = LOW; Run = HIGH

#### Input, blanking input (bln)

PNP: Blanked = HIGH; Free = LOW

NPN: Blanked = LOW; Free = HIGH

#### Input, light/dark (L-d)

PNP: Light switching = LOW; Dark switching = HIGH

NPN: Light switching = HIGH; Dark switching = LOW

### 3.2 Wiring the digital outputs

The number of digital outputs (open collector) available at the connections will vary, depending on the device, see "Pin assignment of the connections", page 17. If the allocated event occurs in the read process, then the corresponding digital output is live.

In each case, the digital outputs are short-circuit protected and overcurrent protected.

Switching behavior: PNP or NPN

#### Electrical values

The sum current (100 mA) per sensor for all digital outputs is identical.

PNP/NPN residual voltage  $\leq 1.8$  V

Dielectric strength max 30 V



#### NOTE

When using sensors in bus operation, the sum current reduces as follows:

- Up to 3 sensors = max. 100 mA
- 4-8 sensors = max. 50 mA
- 9-16 sensor = max. 20 mA

## 4 Connecting the supply voltage



---

**NOTICE****Risk of damage to the device!**

The device can become damaged if it is connected to a voltage supply that is already switched on.

- Only connect the device when the supply cable is de-energized.
- 

The device must be connected to a power supply unit with the following properties:

- Supply voltage DC 10.8 V – 26.4 V (SELV/PELV as per currently valid standards)
- Electricity source with at least 3 W power

To ensure protection against short-circuits/overload in the customer's supply cables, the wire cross-sections used must be appropriately selected and protected.

## Commissioning

### 1 Simplified illustration

Carry out the following steps based on the example of the dynamic teach:

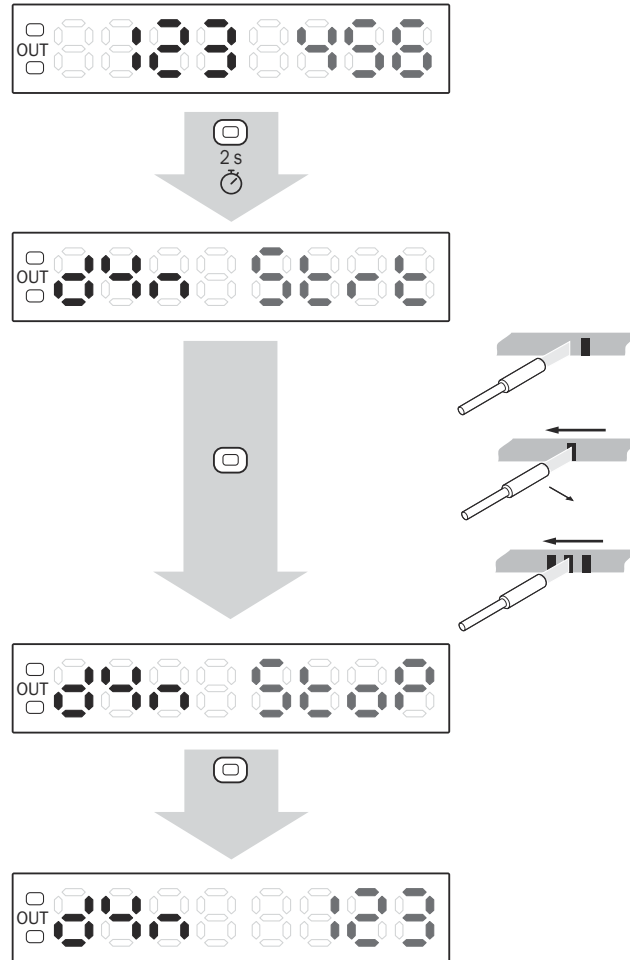

Figure 8: Dynamic teach-in sequence

Table 3: Live measured value display

Value	Remission value
0	No remission
3000	Maximum remission with 16 $\mu$ s response time
9999	Maximum remission at 200 $\mu$ s response time

## Operation

### 1 Operating elements

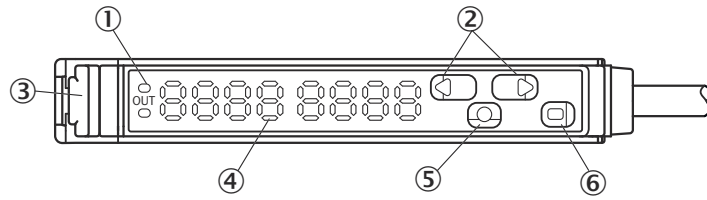

Figure 9: Display and operating elements - version with two switching outputs

- ① Output displays Q<sub>1</sub>, Q<sub>2</sub> depending on variant (orange)
- ② Selection pushbutton (plus and minus button)
- ③ Fiber interlocking
- ④ Display
- ⑤ Mode pushbutton
- ⑥ Teach-in button

Table 4: Operating elements legend

No.	Description	Function
1	OUT	Illuminates when there is a switching event.
2	+/-	Scrolls through menu items or changes values.
3	Fiber interlocking	-
4	Display	Shows menu item or values.
5	MODE	Opens the menu, confirms entries, or switches to lower-level menus.
6	TEACH	Teach-in menu selection or change to higher menu.

en



### 3 Navigation tree, Pro level



en

## 4 List of abbreviations (type-dependent)

Table 5: List of abbreviations

Display	Meaning
1P	1-point teach-in
2P	2-point teach-in
AdC	Automated threshold
Atch	All teach-In
Auto	Automated
Ch	Channel
dAr	Dark
dIY	Delay
diSP	Display switch
dYn	Dynamic teach-in
Eco	Energy-saving mode
Err	Error
GAin	Receiver amplification
Job	Parameter sets
Job1	Parameter set 1
Job2	Parameter set 2
Job3	Parameter set 3
Job4	Parameter set 4
Job5	Parameter set 5
L-d	Light/dark
LGt	Light
LoAd	Load
LocL	Blocked
oFF	Off
OUT	Output
Pro	Pro level (advanced settings)
rES	Reset
SenS	Sensitivity
Sto	Store
tch	Teach-in
thr	Threshold
Turn	Turn (display)

## 5 Defaults

The defaults specify the parameters required for operating the device. It is often the case that only these parameters need to be set in order to use the device.

### 5.1 Teach-in

Several teach-in processes are available for configuring the device:



- 1-point teach-in/color mode
- 2-point teach-in
- Dynamic teach-in

**NOTE**

In the teach-in operating mode, the live measured value can be displayed at any time by pressing the Mode pushbutton.

**NOTE**

When the receiver amplification is set to Auto (factory setting), the amplifier setting of the device is selected when Teach mode is activated.

The fibers and the object to be taught must be positioned before activating the Teach mode.

### 5.1.1 1-point teach-in

When using a 1-point teach-in, the sensor switches by the taught-in contrast value in a tolerance band. The tolerance band can be adjusted, see ["Adjusting the switching sensitivity", page 27](#).

1. Press and hold Teach-in button for 2 s. The Teach-in operating mode is active.
2. Use the plus or minus button to select 1P.

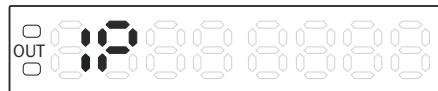

3. Press the teach-in pushbutton. The switching threshold value appears.

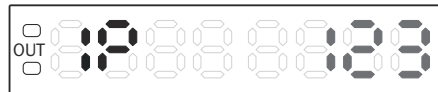

### 5.1.2 2-point teach-in

1. Press and hold Teach-in button for 2 s. The Teach-in operating mode is active.
2. Use the plus or minus button to select 2P.

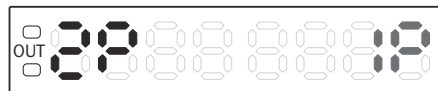

3. Position the mark under the light spot.



4. Press the teach-in button.

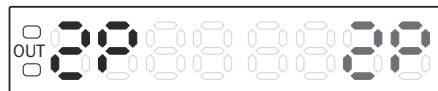

5. Position the background under the light spot.

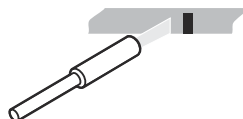

- Press the teach-in button. The switching threshold value appears.

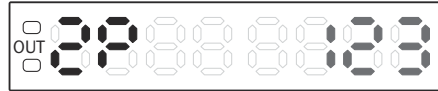

### 5.1.3 Dynamic teach-in

- Press and hold Teach-in button for 2 s. Teach-in operating mode active.
- Use the plus or minus button to select dYn.

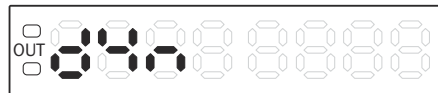

- Press the teach-in button to start.

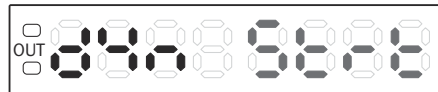

- Let several objects pass.

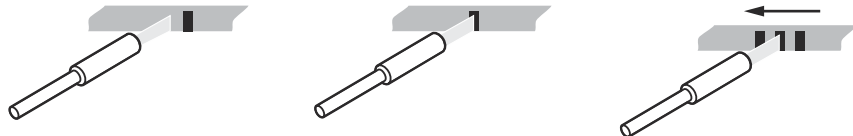

- Press the teach-in button again to stop. The switching threshold value appears.

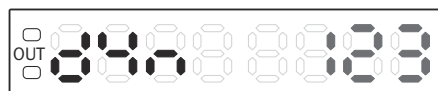
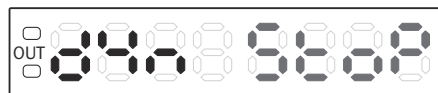

## 5.2 Adjusting switching threshold

During teach-in, the remission value of the switching threshold displayed is automatically set between the mark and background and corresponds to a switching threshold of 50%. If the switching events do not correspond to the expected results, the switching threshold can be adjusted independently of the teach-in process.

- Press the plus or minus button in Run mode. Switching threshold flashes.

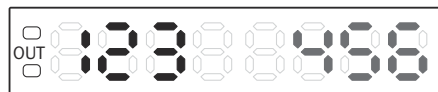

- Adjust in single steps using the plus or minus button.

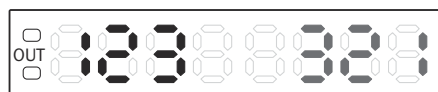

- Press Mode or wait 5 s to confirm.

## 5.3 Adjusting the switching logic (light/dark)

The "AUTO" switching logic is preset (factory setting). The first teach point is used as the mark and the second as the background.



**NOTE**

If the switching logic is changed after a teach-in, the teach-in should be repeated.

**Dark switching**

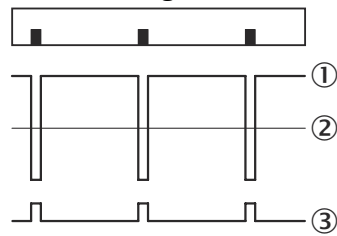

**Light switching**

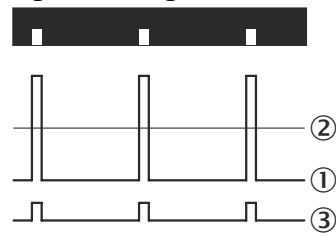

- ① Internal received signal
- ② Switching threshold
- ③ Output Q

1. Press and hold the Mode button for 2 s. The Configuration operating mode is active.
2. Use the plus or minus button to select L-D.

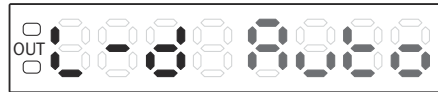

3. Press the Mode pushbutton. The preset value flashes.

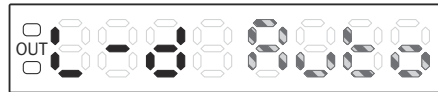

4. Use the plus or minus button to select the required setting.



Automated (factory setting)



Light switching



Dark switching

5. Press the Mode pushbutton.

## 5.4 Adjusting the switching sensitivity



**NOTE**

The system setting can only be used for 1P teach.

The contrast differences that have been taught are stored with a tolerance range. The magnitude of the tolerance range can be set to one of three values (10%, 20%, 50%).

Measurement is more reliable when using a greater tolerance if the contrast differences of the object vary.

1. Press and hold the Mode button for 2 s. The Configuration operating mode is active.
2. Use the plus or minus button to select SEnS.

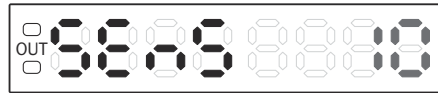

- Press the Mode button. The preset value flashes.



- Use the plus or minus button to define the required setting.



10% (factory setting)



20%



50%

- Press the Mode button.

## 5.5 Adjusting time level

- Press and hold the Mode button for 2 seconds. The Configuration operating mode is active.
- Use the plus or minus button to select dLY.

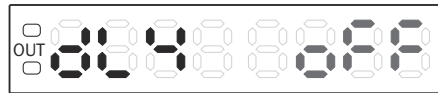

- Press the Mode button. The preset value flashes.

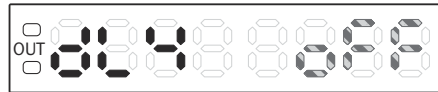

- Use the plus or minus button to select the required setting.



Deactivated (factory setting)



OFF delay



ON delay

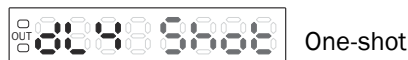

One-shot



ON-OFF delay



On-shot

- Press the Mode button.
- Use the plus or minus button to set the time value if the time delay is activated.
- Press the Mode button.

## 5.6 Selecting canal



### NOTE

Only available for variants with two switching outputs ( $Q_1$ ,  $Q_2$ ).

1. Press and hold the Mode button for 2 s. The Configuration operating mode is active.
2. Use the plus or minus button to select Ch.
3. Press the Mode button. The preset value flashes.
4. Use the plus or minus button to select the required setting.



Channel 1 for  $Q_1$



Channel 2 for  $Q_2$

5. Press the Mode pushbutton.

## 5.7 Activating or deactivating the button lock

Depending on the lock level set, the external input can be locked or unlocked.

1. Press plus or minus button for  $> 1$  s.
2. Loc or unLc appears. The button lock is active or deactivated.

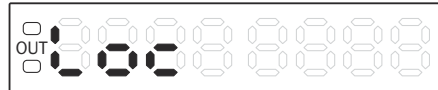

## 6 Pro level (advanced settings)

You can use the advanced settings to adapt the device to the particular application conditions or to configure additional values and functions.

### Leaving Pro level

There are several options for leaving the Pro level.

- Press the teach-in button to change to the previous menu level.
- Press and hold Teach-in button for 2 s to change to Run mode.

### 6.1 Adjusting response time

1. Press and hold the Mode button for 2 s. The Configuration operating mode is active.
2. Use the plus or minus button to select Pro.

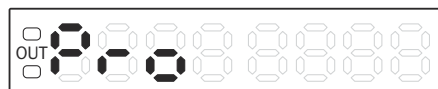

3. Press the Mode button.
4. Use the plus or minus button to select rESP.



- Press the Mode button. The preset value flashes.

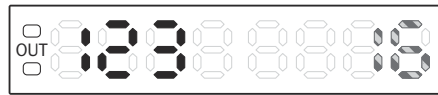

- Use the plus or minus button to select the required setting.



16  $\mu$ s (factory setting)



200  $\mu$ s

- Press the Mode button.

## 6.2 Setting display value to to zero

This function can be used to change the display of the live measured value and the switching threshold. If the function is activated, the live measured value is shifted to 0; the same offset is then subtracted from the switching threshold.



### NOTE

The switching outputs and the measured value transmitted to the bus are not affected by this.

- Press and hold the Mode button for 2 s. The Configuration operating mode is active.
- Use the plus or minus button to select Pro.

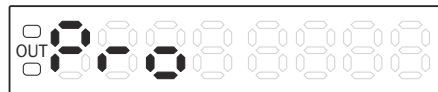

- Press the Mode button.
- Use the plus or minus button to select oFSt.

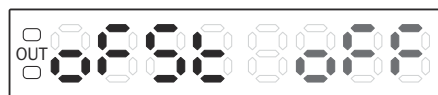

- Press the Mode button. The preset value flashes.

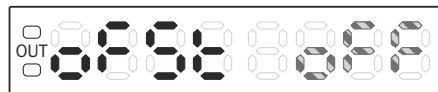

- Use the plus or minus button to select on or oFF.



Deactivated (factory setting)



Active

- Press the Mode button.

## 6.3 Selecting display settings

1. Press and hold the Mode button for 2 s. The Configuration operating mode is active.
2. Use the plus or minus button to select Pro.

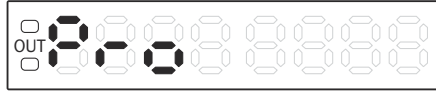

3. Press the Mode button.
4. Use the plus or minus button to select diSP.

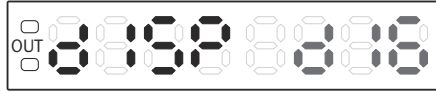

5. Press the Mode button. The preset value flashes.

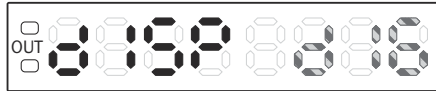

6. Use the plus or minus button to select the desired display.

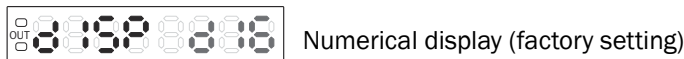

Numerical display (factory setting)



Bar display



Percent display

7. Press the Mode button.

## 6.4 Activating energy-saving mode

If energy-saving mode is activated, the set point display (green display) is switched off 20 seconds after the last time a button is pressed and the red actual value display dims. This reduces the current consumption. Pressing any button activates the display.

1. Press and hold the Mode button for 2 s. The Configuration operating mode is active.
2. Use the plus or minus button to select Pro.

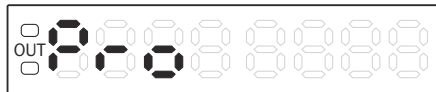

3. Press the Mode button.
4. Use the plus or minus button to select Eco.

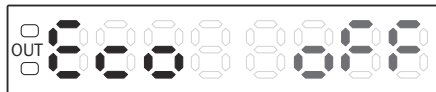

5. Press the Mode button. The preset value flashes.

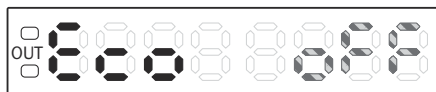

- Use the plus or minus button to select off or on.



- Press the Mode pushbutton.

## 6.5 Rotating the display

If the installation position of the device makes it difficult to read from the segment display, the display can be rotated by 180°.

- Press the Mode button. The Configuration operating mode is active.
- Use the plus or minus button to select Pro.

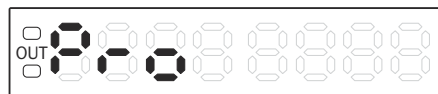

- Press the Mode button.
- Use the plus or minus button to select turn.

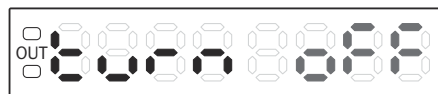

- Press the Mode button. The preset value flashes.

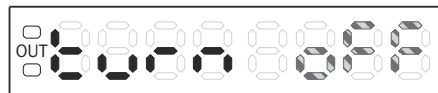

- Use the plus or minus button to select off or on.



- Press the Mode button.

## 6.6 Configuring input

This menu can be used to define the function of the multifunctional input.

- Press and hold the Mode button for 2 s. The Configuration operating mode is active.
- Use the plus or minus button to select Pro.



- Press the Mode button.
- Use the plus or minus button to select Pin.

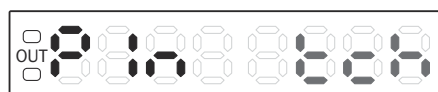



5. Press the Mode button. The preset value flashes.



6. Use the plus or minus button to select the required setting.



External teach-in (factory setting)



Master teach-in



Light/dark

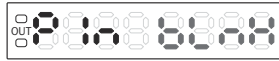

Blanking



Off

7. Press the Mode pushbutton.

#### External teach-in

When the external teach-in is selected, the following options are available:



1-point teach-in



2-point teach-in



Dynamic teach-in

## 6.7 Adjusting copy mode

The copy function is only available in bus operation.

When the copy function is activated, all base unit settings are transmitted to the connected expansion units.



#### WARNING

If the KTL180 is combined with the WLL180T on the bus (see ["Combination with other sensors", page 14](#)), then the copying function is used neither in the KTL180 nor in the WLL180T. Unplanned parameter changes can occur during use. If the copying function is used on accident, then it may be necessary to reset every device on the bus to the factory settings to ensure the specified function.



#### NOTE

No base unit data is transmitted in locked expansion units (LocL1 or 2).  
The copy function is not available with 16 µs response time.

1. Press the Mode pushbutton. The Configuration operating mode is active.
2. Use the plus or minus button to select Pro.

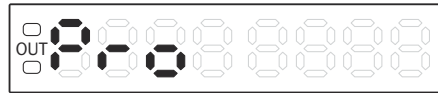

3. Press the Mode button.



4. Use the plus or minus button to select coPY. The preset value flashes.



5. Press the Mode button.

6. Use the plus or minus button to select no or YES.

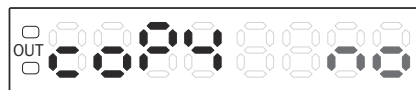

Deactivated (factory setting)

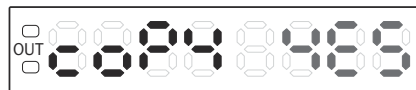

Active

7. Press the Mode button.

## 6.8 Setting master teach-in

Teaching all connected expansion units with master teach-in is only available in bus operation.



### WARNING

If the KTL180 is combined with the WLL180T on the bus (see "[Combination with other sensors](#)", page 14), then the master teach-in is used neither in the KTL180 nor in the WLL180T. Unplanned parameter changes can occur during use. If the master teach-in function is used on accident, then it may be necessary to reset every device on the bus to the factory settings to ensure the specified function.



### NOTE

Locked (LocL1 or 2) expansion units are not taught.

1. Press and hold the Mode button for 2 s. The Configuration operating mode is active.

2. Use the plus or minus button to select Pro.



3. Press the Mode button.

4. Use the plus or minus button to select Atch.

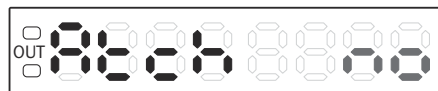

5. Press the Mode button. The preset value flashes.

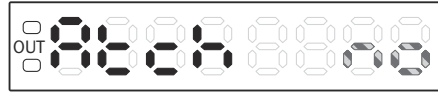

- Use the plus or minus button select no or YES.



Deactivated (factory setting)



Active

- Press the Mode button.



#### NOTE

When using the “2-point” or “Dynamic” teach-in mode, the second teach-in point must then be defined by pressing the mode pushbutton. When combining units with different teach-in types, it might be necessary to also define the second teach-in point. In this case, units with 1-point teach-in are not influenced.

## 6.9 Setting synchronization

The synchronization type is only available in bus operation. If synchronization is switched off, fiber contrast sensors measure independently of each other at maximum speed in bus operation. However, mutual interference can occur if the field of view of the fibers overlaps.

If synchronization is switched on, fiber contrast sensors measure in sync one after another to prevent mutual interference. This reduces the measurement speed.

- Press and hold the Mode button for 2 s.
- Use the plus or minus button to select Pro.

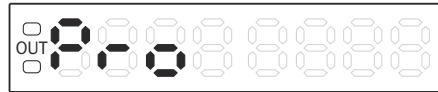

- Press the Mode button.
- Use the plus or minus button to select SYnC.

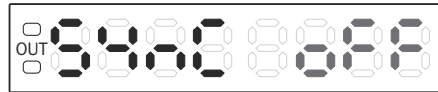

- Press the Mode button. The preset value flashes.

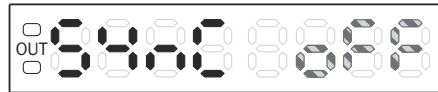

- Use the plus or minus button to select on or oFF.

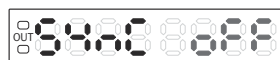

Deactivated (factory setting)

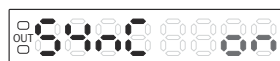

Active

- Press the Mode button.

## 6.10 Setting continuous threshold adaptation

When continuous threshold adaptation is switched on, slow changes to the signal level are monitored. When such changes occur, the threshold is changed appropriately. This function can help to ensure reliable switching even in environments with increased contamination.

1. Press and hold the Mode button for 2 s.
2. Use the plus or minus button to select Pro.

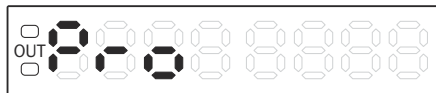

3. Press the Mode button.
4. Use the plus or minus button to select AdC.

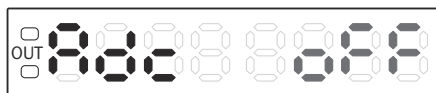

5. Press the Mode button. The preset value flashes.

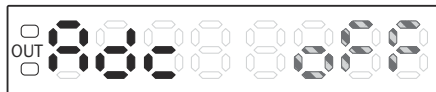

6. Use the plus or minus button to select on or oFF.

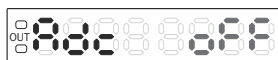

Deactivated (factory setting)

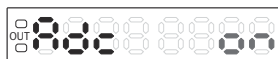

Active

7. Press the Mode button.

## 6.11 Setting receiver amplification

The factory setting for receiver amplification is “Auto”. In this operating mode, the sensor selects a suitable amplification during the teach-in process based on the measured signal. For special applications (e.g. with high contrast fluctuations), it may make sense to define the amplification manually.

1. Press and hold the Mode button for 2 s. The Configuration operating mode is active.
2. Use the plus or minus button to select Pro.



3. Press the Mode button.
4. Use the plus or minus button to select GAin.

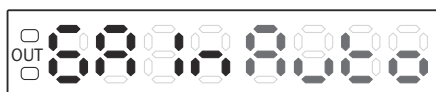

5. Press the Mode button. The preset value flashes.

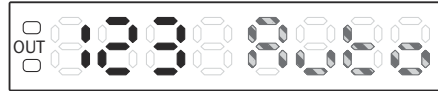

- Use the plus or minus button to select the desired setting.

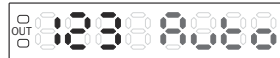

Automated (factory setting)

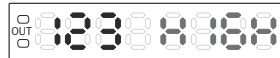

High

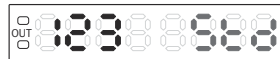

Standard



Low

- Press the Mode button.

## 6.12 Setting pushbutton lock

This function can be used to define to what extent the device is locked when the key lock is triggered (see ["Activating or deactivating the button lock"](#), page 29).

Level 1 (L1): All entry functions are locked (pushbuttons and multifunctional input).

Level 2 (L2): All pushbutton entry functions are locked, only external multifunctional input functional.

- Press and hold the Mode button for 2 s. The Configuration operating mode is active.
- Use the plus or minus button to select Pro.

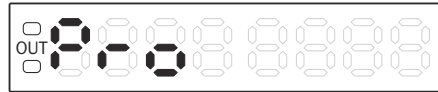

- Press the Mode button.
- Use the plus or minus button to select LocL.

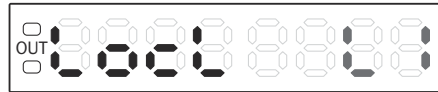

- Press the Mode button. The preset value flashes.

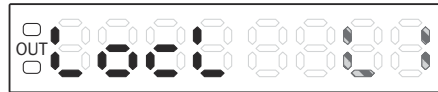

- Use the plus or minus button to select L1 (level 1) or L2 (level 2).



Level 1 (standard)

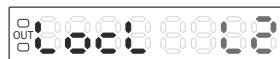

Level 2

- Press the Mode button.

## 6.13 Storing or loading a parameter set (job)

Stored parameter sets (jobs) make it possible to permanently save and flexibly manage specific application parameters (e.g., teach process, etc.) in the device for certain marks or applications.

1. Press and hold the Mode button for 2 s. The Configuration operating mode is active.
2. Use the plus or minus button to select Pro.

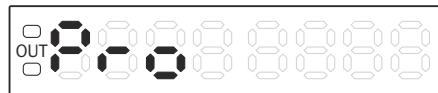

3. Press the Mode button.
4. Use the plus or minus button to select Job.

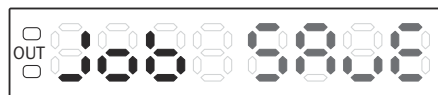

5. Press the Mode button. The preset value flashes.

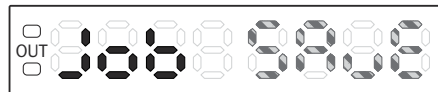

6. Use the plus or minus button to choose between SAvE (store) and LoAd (load).

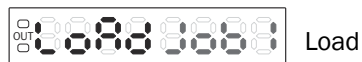

7. Press the Mode button.
8. Use the plus or minus button to select one of the 5 memory locations (Job2 to Job5).
9. Press the Mode button.

## 6.14 Displaying firmware version

1. Press and hold the Mode button for 2 s. The Configuration operating mode is active.
2. Use the plus or minus button to select Pro.

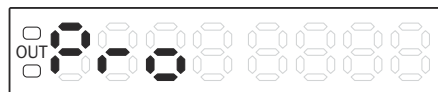

3. Press the Mode button.
4. Use the plus or minus button to select VEr.

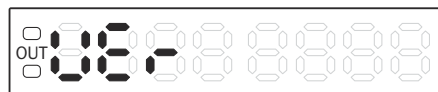

5. Press the Mode button. The firmware version is displayed.

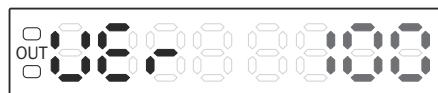

## 7 Other indicators and functions

### Incorrect teach-in

In the event of a teach-in failure, Err 1, Err 2 or Err 3 is shown in the display (see "", page 41).

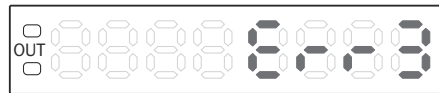
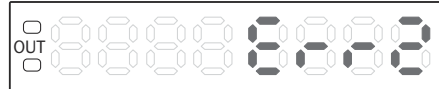

### Live measured value (run mode)

In run mode, the device displays the remission value currently being measured as a digit.

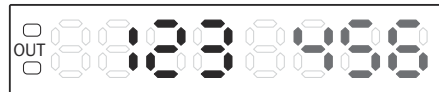
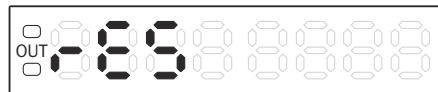

Table 6: Remission value indicator

Value	Remission value
0	No remission
3000	Maximum remission at 16 $\mu$ s response time
9999	Maximum remission at 200 $\mu$ s response time

## 8 Resetting the device (factory setting)

1. Press and hold the Mode button for 2 s. The Configuration operating mode is active.
2. Use the plus or minus button to select rES.



3. Press the Mode button.
4. Use the plus or minus button to select no or YES.

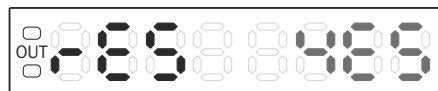
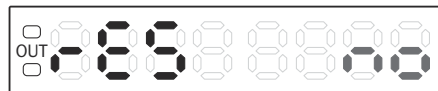

5. Press the Mode button.

6. Use the plus or minus button to select End.
7. Press the Mode button.

Table 7: Factory settings

Setting	Value
Switching mode	Automated
Sensitivity	10
Response time	16 $\mu$ s
Time delay	Off
Setting display value to zero	Off
Display setting	Numerical display
energy-saving mode	Off
Display rotation	Off
Input setting	External teach-in
Synchronization	Off
ACD setting	Off
Receiver amplification	Automated
Key lock	Level 1



## Troubleshooting

### 1 Possible errors during commissioning

Table 8: Troubleshooting during commissioning

Display, error situation	Cause	Measure
After the teach process <ul style="list-style-type: none"> <li>• “Err1” is displayed</li> <li>• “Err2” is displayed</li> <li>• “Err3” is displayed</li> </ul>	Programmed contrast or contrast difference is not sufficient for stable contrast detection. <ul style="list-style-type: none"> <li>• “Err1”: Receive value is too low</li> <li>• “Err2”: Receive value is saturated</li> <li>• “Err3”: Difference between two receive values is too small</li> </ul>	<ul style="list-style-type: none"> <li>• Readjust fibers</li> <li>• Clean fibers</li> <li>• Check the application conditions</li> <li>• Restart teach process</li> <li>• Increase contrast difference</li> </ul>

### 2 Possible errors during operation

en

Table 9: Troubleshooting during operation

Fault pattern	Cause	Measure
No switching output any more	<ul style="list-style-type: none"> <li>• Distance or angle to material not consistent</li> <li>• Light emission (optics) is dirty</li> <li>• Manual switching threshold set incorrectly</li> <li>• Fibers have detached from the amplifier</li> </ul>	<ul style="list-style-type: none"> <li>• Clean fibers</li> <li>• Readjust fibers</li> <li>• Check parameter settings</li> <li>• Perform teach process again</li> <li>• Check fiber mounting</li> </ul>

## Maintenance

### 1 Maintenance

During operation, the device works maintenance-free.

Depending on the assignment location, the following preventive maintenance tasks may be required for the device at regular intervals:

Table 10: Maintenance schedule

Maintenance work	Interval	Implementation
Clean fibers/optics	Cleaning interval depends on ambient conditions and climate	Specialist
Check screw connections and plug connectors	Every 6 months	Specialist

### 2 Cleaning the device

At regular intervals (e.g., weekly), check the fibers and any attachments as well as housing of the device for contamination. This is especially relevant in harsh operating environments (dust, abrasion, damp, fingerprints, etc.).



#### NOTICE

##### Device damage due to improper cleaning!

Improper cleaning may result in device damage.

- Only use suitable cleaning agents.
- Never use sharp objects for cleaning.

#### Cleaning the light emission window



#### NOTICE

##### Damage to the fiber outlet!

Reduced reading performance due to scratches or streaks on the fiber outlet!

- ▶ Always use a damp cloth to clean the fiber outlet.
- ▶ Use a mild cleaning agent that does not contain powder additives. Do not use aggressive cleaning agents, such as acetone, etc.
- ▶ Avoid any movements that could cause scratches or abrasions on the light emission window.
- ▶ Only use cleaning agents suitable for the fiber material.



#### NOTE

Static charge may cause dust particles to stick to the fiber outlet. This effect can be avoided by using an anti-static glass cleaner in combination with the SICK lens cloth (can be obtained from [www.sick.com](http://www.sick.com)).



#### NOTE

If the fiber outlet is scratched or damaged (cracked or broken), the device must be replaced. Contact SICK Service to arrange this.

**Cleaning the housing**

In order to ensure that the heat produced by the internal power loss is adequately dissipated, the housing surface must be kept clean.

en

## Decommissioning

### 1 Disassembly and disposal

#### Disassembling the device

1. Switch off the supply voltage to the device.
2. Detach all connecting cables from the device.
3. If the device is being replaced, mark its position and alignment on the bracket or surroundings.
4. Detach the device from the bracket.

#### Disposing of the device

Any device which can no longer be used must be disposed of in an environmentally friendly manner in accordance with the applicable country-specific waste disposal regulations.



#### NOTE

##### Disposal of batteries, electric and electronic devices

- According to international directives, batteries, accumulators and electrical or electronic devices must not be disposed of in general waste.
- The owner is obliged by law to return this devices at the end of their life to the respective public collection points.



■ This symbol on the product, its package or in this document, indicates that a product is subject to these regulations.

### 2 Returning devices

- ▶ Do not dispatch devices to the SICK Service department without consultation.



#### NOTE

To enable efficient processing and allow us to determine the cause quickly, please include the following when making a return:

- Details of the contact person
- Description of the application
- Description of the fault that occurred

## Technical data

### 1 General data

Table 11: Technical data

Attribute	Value
Connection type	Male connector, M8 4-pin/pigtail (30 cm), M12 5-pin
Switching output	NPN/PNP Open collector 100 mA / $\leq 30$ V DC resistive Load current: $\leq 100$ mA <sup>1)</sup> Residual voltage: $\leq 1.8$ V
Supply voltage $U_V$	12 ... 24 V DC $\pm 10\%$ including residual ripple <sup>2)</sup>
Power consumption	$\leq 50$ mA / 24 V
Response time	16 $\mu$ s / 200 $\mu$ s
Output	Light/dark switching
Short-circuit protection	✓
Light source	White LED
Status indicator/display	Output display: Orange (Q1 and Q2 depending on the variant) 2 x 4-digit 7-segment display
Input, teach-in (tch)	PNP: Teach: $U = 6.5$ V ... $< U_V$ Run: $U < 5.5$ V NPN: Teach: $U < 1$ V Run: $U = 1.5$ V ... $U_V$ Minimum pulse: 200 ms
Input, blanking input (blink) – blanked/free	PNP: Blanked: $U = 6.5$ V ... $< U_V$ Free: $U < 5.5$ V NPN: Blanked: $U < 1$ V Free: $U = 1.5$ V ... $U_V$ Minimum pulse: 300 $\mu$ s
Input, light/dark (L/D)	PNP: Light switching: $U < 6.5$ V Dark switching: $U = 5.5$ V ... $< U_V$ NPN: Light switching: $U = 1.5$ V Dark switching: $U < 1$ V Minimum pulse: 300 $\mu$ s
Input, master teach-in (Atch)	PNP: Teach: $U = 6.5$ V ... $< U_V$ Run: $U < 5.5$ V NPN: Teach: $U < 1$ V Run: $U = 1.5$ V ... $< U_V$ Minimum pulse: 200 ms
Ambient temperature operation	$-25$ ... $+55$ °C / 35 ... 85% RF (no frost, no condensation) <sup>4)</sup>
Ambient temperature, storage	$-40$ ... $+70$ °C / 35 ... 85% RF (no frost, no condensation)
Vibration resistance	10 ... 55 Hz double amplitude 1.5 mm 2 h in every direction x, y, z
Shock resistance	50 g, 11 ms

en

Attribute	Value
Protection class	III
Circuit protection	U <sub>V</sub> connections reverse polarity protected, inputs and outputs reverse polarity protected, interference suppression, outputs overcurrent and short-circuit protected
Enclosure rating	IP 50 <sup>3)</sup>
Housing material	PC
Weight	Cable type: 71 g, M8 type: 25 g

- 1) Max. ambient temperature: +55 °C  
Temp./max. number of devices:  
-25 ... +55 °C / 3 devices (load current: 100 mA max.)  
-25 ... +50 °C / 8 devices (load current: 50 mA max.)  
-25 ... +45 °C / 16 devices (load current: 20 mA max.)
- 2) Class 2 voltage supply
- 3) UL housing type 1

## 2 Dimensional drawings

en

Device variant without bus male connector (standalone)

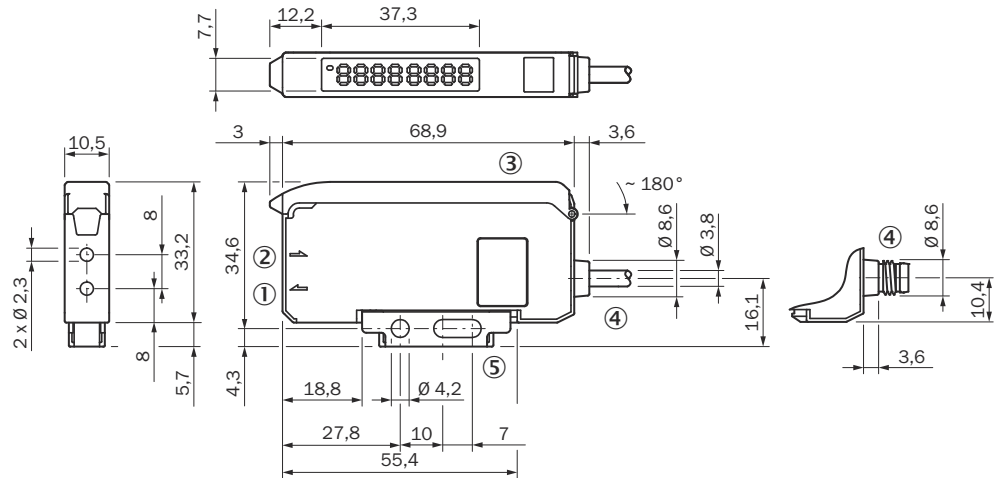

Figure 10: Device variant dimensional drawing without bus male connector (standalone)

- ① Sender LED, LL3 fiber mounting (sender fibers)
- ② Receiver, LL3 fiber mounting (receiver fibers)
- ③ Protective hood opens approx. 180°
- ④ Connection
- ⑤ Mounting bracket, included with delivery

Device variants without bus male connector (basic unit)

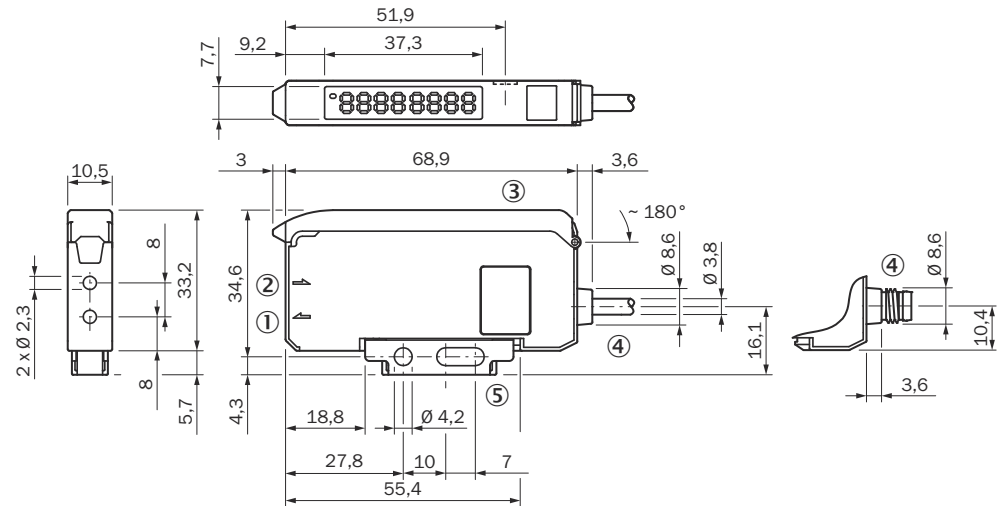

Figure 11: Device variant dimensional drawing without bus male connector (basic unit)

- ① Sender LED, LL3 fiber mounting (sender fibers)
- ② Receiver, LL3 fiber mounting (receiver fibers)
- ③ Protective hood opens approx. 180°
- ④ Connection
- ⑤ Mounting bracket, included with delivery

en

Device variants with bus male connector (extension unit)

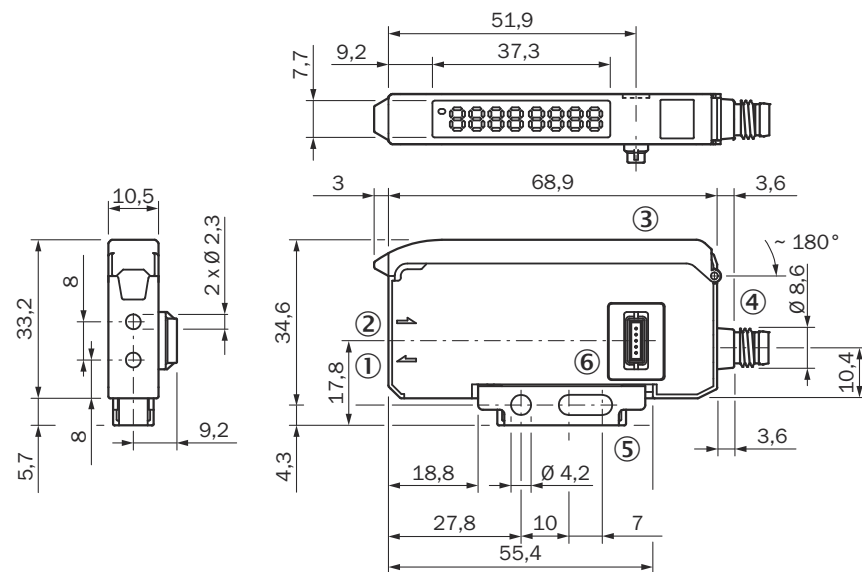

Figure 12: Device variant dimensional drawing with bus male connector (extension unit)

- ① Sender LED, LL3 fiber mounting (sender fibers)
- ② Receiver, LL3 fiber mounting (receiver fibers)
- ③ Protective hood opens approx. 180°
- ④ Connection
- ⑤ Mounting bracket, included with delivery
- ⑥ Bus male connector

## Accessories



---

**NOTE**

Accessories can be found on the online product page at:

- ▶ [www.sick.com/KTL180](http://www.sick.com/KTL180)
-



## Annex

### 1 Conformities and certificates

You can obtain declarations of conformity, certificates and the current documentation for the product at [www.sick.com](http://www.sick.com). To do so, enter the product part number in the search field (part number: see the entry in the “P/N” or “Ident. no.” field on the type label).

### 2 Certification according to UL60947-5-2

Device variant with M8-Stecker



Device variant with M12-Pigtail



The KTL180 series fiber contrast sensors are certified in accordance with UL60947-5-2 if it is supplied with power by LPS or Class 2 power supply units.

The certification is only valid with corresponding device identification on the type label of the respective device.

en

en



**Australia**

Phone +61 (3) 9457 0600  
1800 33 48 02 – tollfree  
E-Mail sales@sick.com.au

**Austria**

Phone +43 (0) 2236 62288-0  
E-Mail office@sick.at

**Belgium/Luxembourg**

Phone +32 (0) 2 466 55 66  
E-Mail info@sick.be

**Brazil**

Phone +55 11 3215-4900  
E-Mail comercial@sick.com.br

**Canada**

Phone +1 905.771.1444  
E-Mail cs.canada@sick.com

**Czech Republic**

Phone +420 234 719 500  
E-Mail sick@sick.cz

**Chile**

Phone +56 (2) 2274 7430  
E-Mail chile@sick.com

**China**

Phone +86 20 2882 3600  
E-Mail info.china@sick.net.cn

**Denmark**

Phone +45 45 82 64 00  
E-Mail sick@sick.dk

**Finland**

Phone +358-9-25 15 800  
E-Mail sick@sick.fi

**France**

Phone +33 1 64 62 35 00  
E-Mail info@sick.fr

**Germany**

Phone +49 (0) 2 11 53 010  
E-Mail info@sick.de

**Greece**

Phone +30 210 6825100  
E-Mail office@sick.com.gr

**Hong Kong**

Phone +852 2153 6300  
E-Mail ghk@sick.com.hk

**Hungary**

Phone +36 1 371 2680  
E-Mail ertesites@sick.hu

**India**

Phone +91-22-6119 8900  
E-Mail info@sick-india.com

**Israel**

Phone +972 97110 11  
E-Mail info@sick-sensors.com

**Italy**

Phone +39 02 27 43 41  
E-Mail info@sick.it

**Japan**

Phone +81 3 5309 2112  
E-Mail support@sick.jp

**Malaysia**

Phone +603-8080 7425  
E-Mail enquiry.my@sick.com

**Mexico**

Phone +52 (472) 748 9451  
E-Mail mexico@sick.com

**Netherlands**

Phone +31 (0) 30 229 25 44  
E-Mail info@sick.nl

**New Zealand**

Phone +64 9 415 0459  
0800 222 278 – tollfree  
E-Mail sales@sick.co.nz

**Norway**

Phone +47 67 81 50 00  
E-Mail sick@sick.no

**Poland**

Phone +48 22 539 41 00  
E-Mail info@sick.pl

**Romania**

Phone +40 356-17 11 20  
E-Mail office@sick.ro

**Russia**

Phone +7 495 283 09 90  
E-Mail info@sick.ru

**Singapore**

Phone +65 6744 3732  
E-Mail sales.gsg@sick.com

**Slovakia**

Phone +421 482 901 201  
E-Mail mail@sick-sk.sk

**Slovenia**

Phone +386 591 78849  
E-Mail office@sick.si

**South Africa**

Phone +27 10 060 0550  
E-Mail info@sickautomation.co.za

**South Korea**

Phone +82 2 786 6321/4  
E-Mail infokorea@sick.com

**Spain**

Phone +34 93 480 31 00  
E-Mail info@sick.es

**Sweden**

Phone +46 10 110 10 00  
E-Mail info@sick.se

**Switzerland**

Phone +41 41 619 29 39  
E-Mail contact@sick.ch

**Taiwan**

Phone +886-2-2375-6288  
E-Mail sales@sick.com.tw

**Thailand**

Phone +66 2 645 0009  
E-Mail marcom.th@sick.com

**Turkey**

Phone +90 (216) 528 50 00  
E-Mail info@sick.com.tr

**United Arab Emirates**

Phone +971 (0) 4 88 65 878  
E-Mail contact@sick.ae

**United Kingdom**

Phone +44 (0)17278 31121  
E-Mail info@sick.co.uk

**USA**

Phone +1 800.325.7425  
E-Mail info@sick.com

**Vietnam**

Phone +65 6744 3732  
E-Mail sales.gsg@sick.com

Detailed addresses and further locations at [www.sick.com](http://www.sick.com)