



V 12-2 Miniature photoelectric switches: innovations in M12 housings

	Photoelectric proximity switches
	Photoelectric reflex switches
	Through-beam photoelectric switches



The V 12-2 photoelectric switch series in round miniature housings provides more than “just” extensive scanning ranges.

V 12-2 sensors are the ideal option for standard applications where space is restricted. In addition, V 12-2 photoelectric switches are the perfect complement to inductive or capacitive sensors in M12 housings.

Special focal points are applications in:

- The packaging and printing industries,
- assembly and handling systems,
- conveyor systems, and
- the construction of special-purpose machines.

The V 12-2 optic sensors and their ranges in overview:

- VS/VE 12-2 through-beam photoelectric switch: 5 m,
- VL 12-2 photoelectric reflex switch: 2.8 m (PL 80 A), switching reliability even with reflecting objects thanks to polarization filter and red LED transmitter.
- VT 12-2 photoelectric proximity switch, energetic: two scanning ranges scr. 300 mm and scr. 100 mm (90 % remission), manual sensitivity setting per Teach-in button and electronically per control input C.

Two Teach-in modes provide simple optimization options for VT 12T-2:

- Substantial operating reserve for standard applications,
- precise switching point and small hysteresis for special tasks,
- optical display of the operating reserve (alarm display) by blinking LED indicator.

Flexible and minimum variants in spite of this: Freely selectable switching type light-switching (L.ON) or dark-switching (D.ON) per control line.

$V_S = 10 \dots 30 \text{ V DC}$; switching output Q either in PNP or NPN; M12 plug or cable, IP 67 and sturdy metal housing are additional V 12-2 system strengths.

► Detecting objects on conveyor belts using VS/VE 12-2 through-beam photoelectric switches.

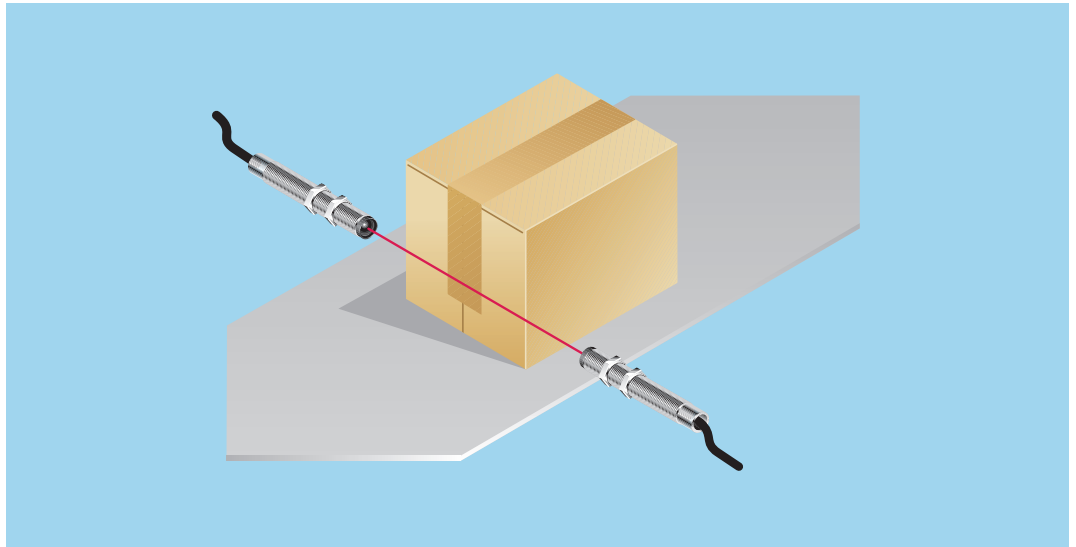

▼ VL 12-2 photoelectric reflex switches can also be used for the reliable detection of reflective surfaces, for example film-wrapped cardboard boxes.

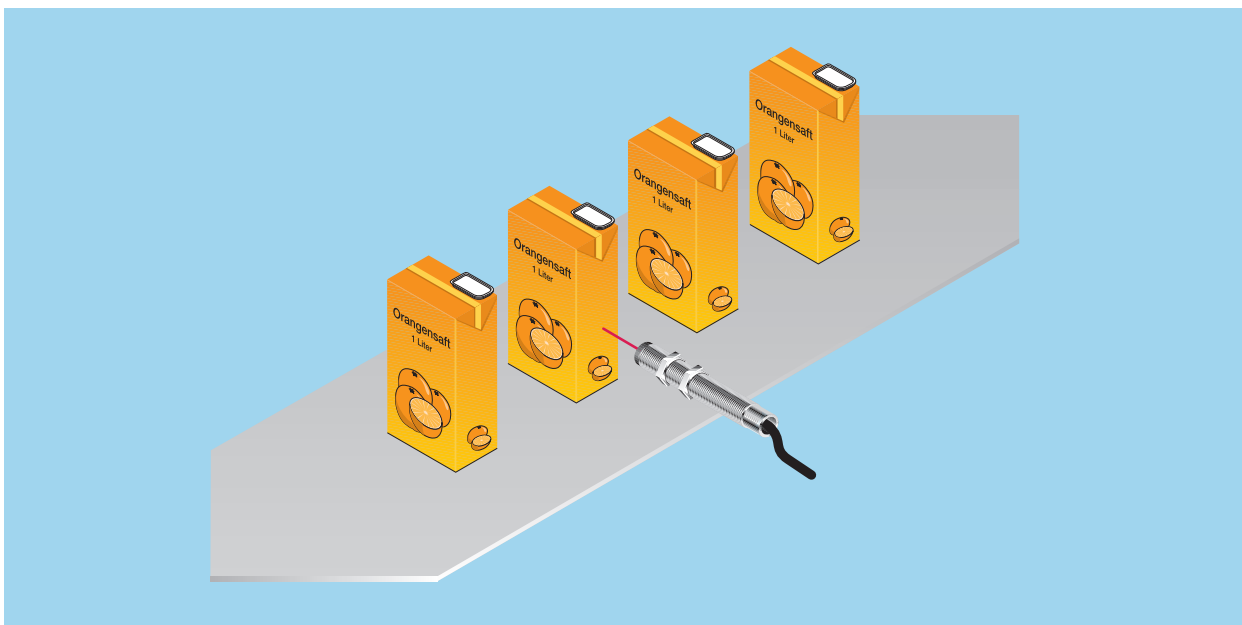
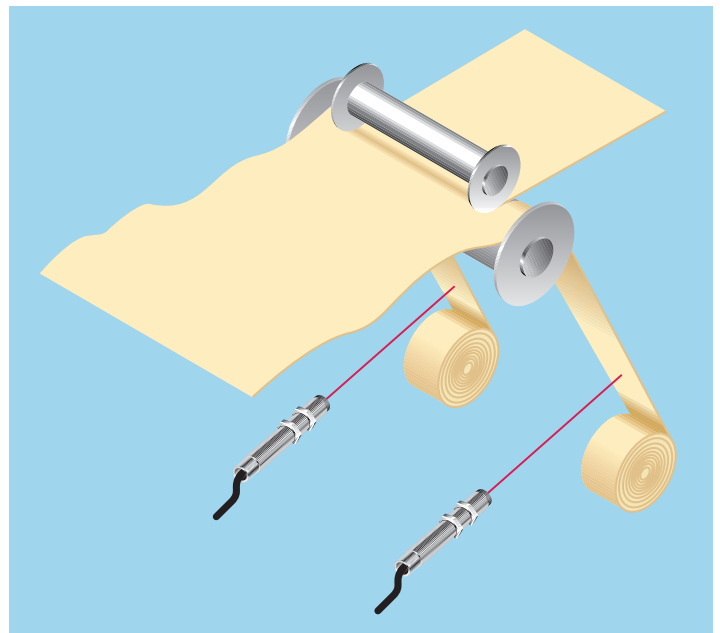
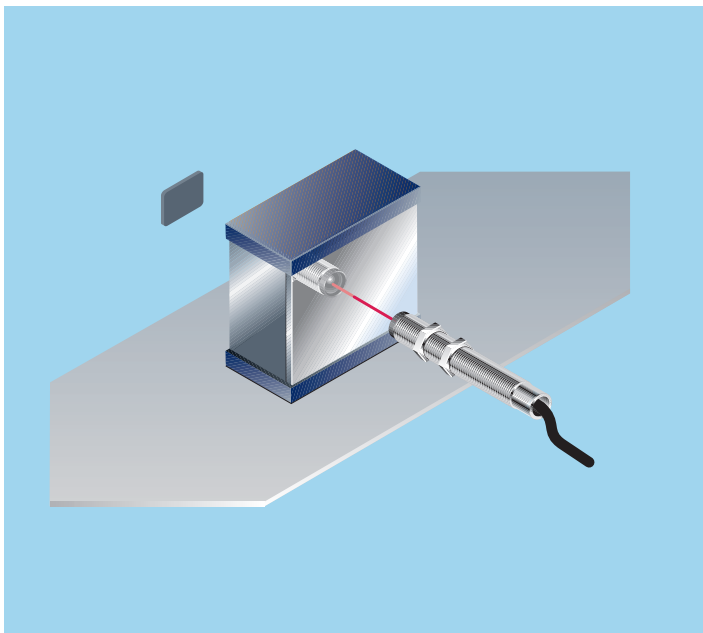

▲ VT 12-2 photoelectric proximity switches used to ensure that waste is rolled up correctly when paper and film strips are cut.

◀ Is an object present or not? The VT 12-2 photoelectric proximity switch provides the answer.

Scanning distance
 0 ... 115 mm
 0 ... 340 mm

Photoelectric proximity switches

- Sensitivity (scanning range) can be set per Teach-in at the “push of a button” or per control input C
- Minimum number of variants: Switching type L.ON or D.ON selectable per control input C
- Optic pre-failure message via operating reserve display

Maßbild

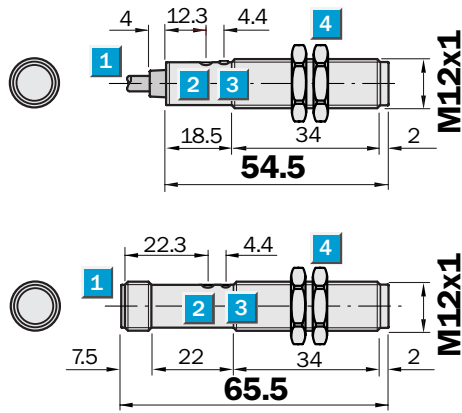

Adjustments possible VT 12T-2

VT 12T-2P 112	VT 12T-2N 112
VT 12T-2P 410	VT 12T-2N 410
VT 12T-2P 132	VT 12T-2N 132
VT 12T-2P 430	VT 12T-2N 430

- 1 Cable or plug M12, 4-pin
- 2 Sensitivity adjustment (Teach-in button)
- 3 Yellow LED indicator:
 – lights continuously: reception signal > reserve factor 2
 – blinks: Reception signal < reserve factor 2 but > switching threshold 1
- 4 Mounting nuts (2x), SW 17, metal

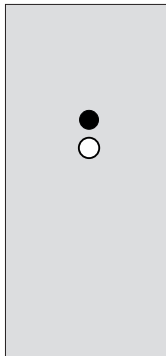

Connection types

VT 12T-2P 112	VT 12T-2P 410
VT 12T-2N 112	VT 12T-2N 410
VT 12T-2P 132	VT 12T-2P 430
VT 12T-2N 132	VT 12T-2N 430

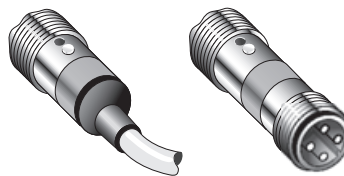

4 x 0.14 mm² 4-pin, M12

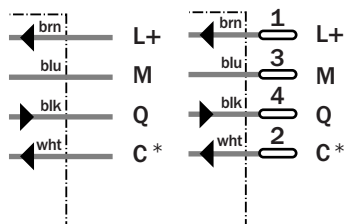

* Control input C, programming:
 – Switching type L.ON/D.ON and
 – External Teach-in
 C = open (not assigned) light-switching L.ON
 C = + V_S: dark-switching D.ON
 C = 0 V: sensitivity setting per “external Teach-in” active



See chapter Accessories
 Cables and connectors
 Mounting systems

Technical data		VT 12T-2	P 112	P 410	N 112	N 410	P 132	P 430	N 132	N 430
Scanning distance , max. typical ¹⁾	0 ... 115 mm									
	0 ... 340 mm									
Operating distance ¹⁾	2 ... 100 mm									
	2 ... 300 mm									
Sensitivity setting	Manual, per Teach-in button									
	Electronic, per control input C (0 V) ²⁾									
Light source ³⁾ , light type	LED, infrared light									
Light spot diameter	Approx. 20 mm at 100 mm									
	Approx. 28 mm at 300 mm									
Angle of dispersion of sender	Approx. 11.4° (SD = max.),									
	Approx. 22.6° (SD = 1/2 max.)									
	Approx. 5.3° (SD = max.),									
	Approx. 11.2° (SD = 1/2 max.)									
Supply voltage V_S	10 ... 30 V DC ⁴⁾									
Ripple ⁵⁾	≤ 10 %									
Current consumption ⁶⁾	≤ 20 mA									
Switching outputs	Q: PNP									
	Q: NPN									
Output current I_A max.	≤ 100 mA									
Switching mode	Light-/Dark-switching selectable ²⁾									
Response time ⁷⁾	≤ 1.25 ms									
Switching frequency max. ⁸⁾	400/s									
Connection types	Cable ⁹⁾	PVC, 2 m, 4 x 0.14 mm ² , Ø 3.75 mm								
	Plug	M12, 4-pin								
VDE protection class ¹⁰⁾	□									
Circuit protection ¹¹⁾	A, B, C, D									
Enclosure rating	IP 67									
Ambient temperature T_A	Operation	-25 °C ... +70 °C								
	Storage	-25 °C ... +70 °C								
Weight	With cable	Approx. 54 g								
	With plug	Approx. 18 g								
Housing material	Housing:	Nickel-coated brass/PA								
	Optics:	PC								

¹⁾ Object to be detected with 90 % remission (relating to standard white in acc. with DIN 5033); 100 x 100 mm

²⁾ Control input C
 - L.ON/D.ON and
 - external Teach-in
 C = open: light-switching L.ON
 C = + V_S : dark-switching D.ON
 C = 0 V: Sensitivity setting per "external Teach-in" active

³⁾ Average service life 100,000 h at $T_A = +25 °C$
⁴⁾ Limit values
⁵⁾ May not exceed or fall short of V_S tolerances
⁶⁾ Without load
⁷⁾ Signal transit time with resistive load

⁸⁾ With light/dark ratio 1:1
⁹⁾ Do not bend below 0 °C
¹⁰⁾ Reference voltage 50 V DC
¹¹⁾ A = V_S connections reverse-polarity protected
 B = Inputs and output reverse-polarity protected
 C = Interference pulse suppression
 D = Outputs overload and short-circuit protected

115 mm Scanning distance

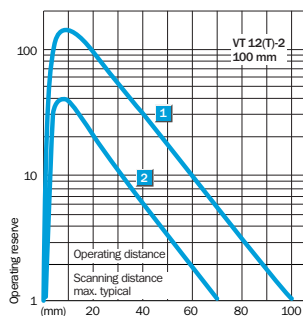
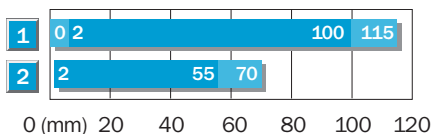

340 mm Scanning distance

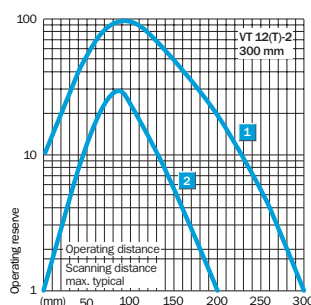
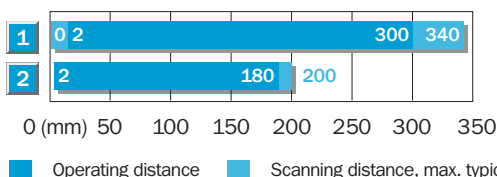

Order information

Type	Order no.
VT 12T-2P 112	6 026 211
VT 12T-2P 410	6 026 212
VT 12T-2N 112	6 026 209
VT 12T-2N 410	6 026 210
VT 12T-2P 132	6 026 215
VT 12T-2P 430	6 026 216
VT 12T-2N 132	6 026 213
VT 12T-2N 430	6 026 214

	Scanning range 0.03 ... 2.8 m
Photoelectric reflex switches	

- Switching reliability even with reflecting objects thanks to polarization filter and red light
- Minimum number of variants: Switching type L.ON or D.ON selectable per control line L/D
- Optic pre-failure message via operating reserve display

Dimensional drawing

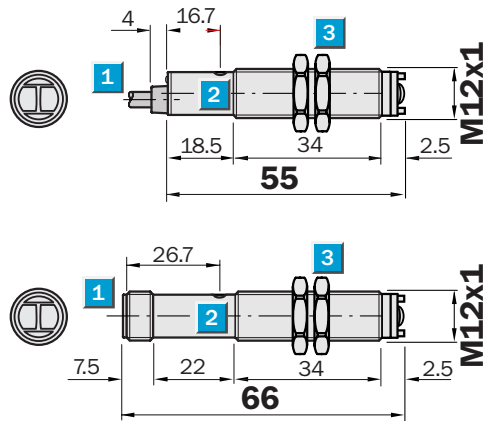

Adjustments possible	
VL 12-2P 132	VL 12-2N 132
VL 12-2P 430	VL 12-2N 430

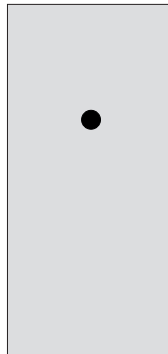

- 1 Cable or plug M12, 4-pin
- 2 Yellow LED indicator:
 - lights continuously: reception signal > reserve factor 2
 - blinks: Reception signal < reserve factor 2 but > switching threshold 1
- 3 Mounting nuts (2x), SW 17, metal



Connection types

VL 12-2P 132	VL 12-2P 430
VL 12-2N 132	VL 12-2N 430

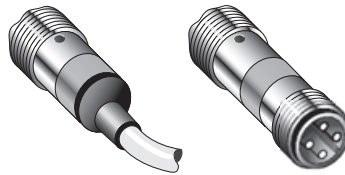

4 x 0.14 mm² | 4-pin, M12

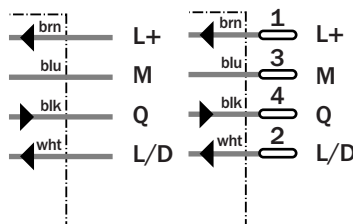

See chapter Accessories
Cables and connectors
Mounting systems

Technical data	VL 12-2	P 132	P 430	N 132	N 430							
-----------------------	---------	-------	-------	-------	-------	--	--	--	--	--	--	--

Scanning range , max. typ./reflector	0.03 ... 2.8 m/PL 80 A				
Operating range	0.03 ... 2.3 m/PL 80 A				
Sensitivity setting	Not available				
Light source¹⁾, light type	LED, red light, with polarization filter				
Light spot diameter	Approx. 80 mm at 2 m				
Angle of dispersion of sender	Approx. 2.3° (SR = max.), Approx. 6.3° (SR = 1/2 max.)				
Supply voltage V_s	10 ... 30 V DC ²⁾				
Ripple ³⁾	≤ 10%				
Current consumption ⁴⁾	≤ 20 mA				
Switching outputs	Q: PNP				
	Q: NPN				
Output current I_A max.	≤ 100 mA				
Switching mode	Light-/Dark-switching selectable ⁵⁾				
Response time ⁶⁾	≤ 1.25 ms				
Switching frequency max. ⁷⁾	400/s				
Connection types	Cable ⁸⁾ PVC, 2 m, 4 x 0.14 mm ² , Ø 3.75 mm				
	Plug M12, 4-pin				
VDE protection class⁹⁾	□				
Circuit protection¹⁰⁾	A, B, C, D				
Enclosure rating	IP 67				
Ambient temperature T_A	Operation - 25 °C ... + 70 °C Storage - 25 °C ... + 70 °C				
Weight	With cable Approx. 54 g With plug Approx. 18 g				
Housing material	Housing: Nickel-coated brass/PA Optics: PC				

1) Average service life 100,000 h at $T_A = +25 °C$
 2) Limit values
 3) May not exceed or fall short of V_s tolerances
 4) Without load

5) L/D switching type control line
 L/D = open (not assigned) dark-switching D.ON
 L/D = + V_s : light-switching L.ON
 L/D = 0 V: dark-switching D.ON

6) Signal transit time with resistive load
 7) With light/dark ratio 1:1
 8) Do not bend below 0 °C
 9) Reference voltage 50 V DC

10) A = V_s connections reverse-polarity protected
 B = Inputs and output reverse-polarity protected
 C = Interference pulse suppression
 D = Outputs overload and short-circuit protected

Scanning range and operating reserve

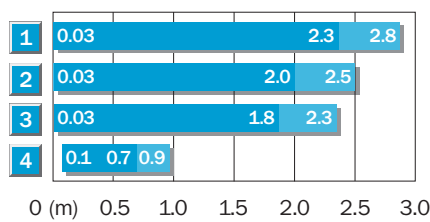

█ Operating range █ Scanning range, max. typical

Reflector type	Operating range
1 PL 80 A	0.03 ... 2.3 m
2 C 110	0.03 ... 2.0 m
3 PL 50 A/PL 40 A/P 250	0.03 ... 1.8 m
4 Reflective tape Diamond Grade	0.1 ... 0.7 m

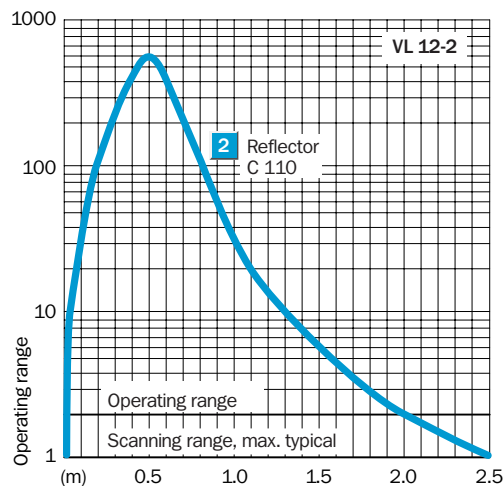

Order information

Type	Order no.
VL 12-2P 132	6 026 219
VL 12-2P 430	6 026 220
VL 12-2N 132	6 026 217
VL 12-2N 430	6 026 218

 **Scanning range**
0 ... 5.0 m

Through-beam photoelectric switches

- Minimum number of variants:
Switching type L.ON or D.ON
selectable per control line L/D
- Sturdy M12 metal housing,
connection cable or M12 plug,
4-pin

Dimensional drawing

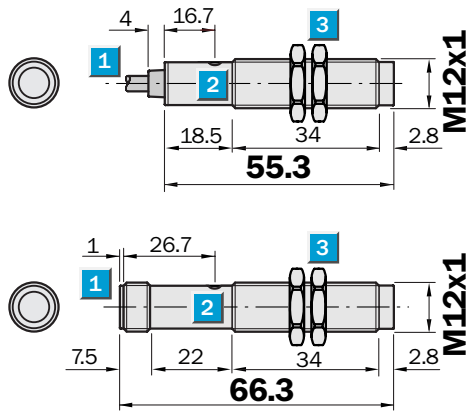

Adjustments possible

VS/VE 12-2P 132	VS/VE 12-2N 132
VS/VE 12-2P 430	VS/VE 12-2N 430

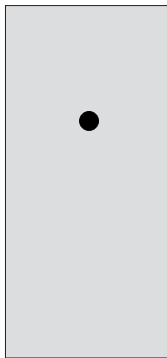

- 1** Cable or plug M12, 4-pin
- 2** Yellow LED indicator (continuously):
Sender VS 12-2:
– power on, sender active
receiver VE 12-2:
– light reception > switching threshold 1
- 3** Mounting nuts (2x), SW 17, metal

Connection types

VS/VE 12-2P 132	VS/VE 12-2P 430
VS/VE 12-2N 132	VS/VE 12-2N 430

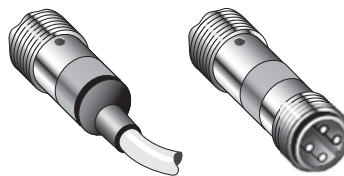

Sender	2 x 0.14 mm ²	4-pin, M12
--------	--------------------------	------------

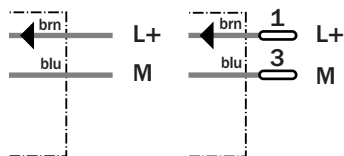

Receiver	4 x 0.14 mm ²	4-pin, M12
----------	--------------------------	------------

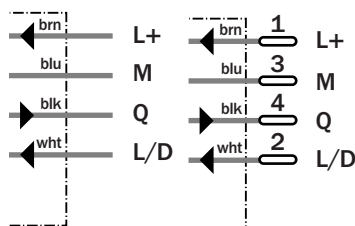

See chapter Accessories
Cables and connectors
Mounting systems

Technical data	VS/VE 12-2	P 132	P 430	N 132	N 430						
-----------------------	------------	-------	-------	-------	-------	--	--	--	--	--	--

Scanning range, max. typ.	0 ... 5.0 m										
Operating range	0 ... 4.0 m										
Sensitivity setting	Not available										
Light source¹⁾, light type	LED, infrared light										
Light spot diameter	Approx. 100 mm at 4 m										
Angle of dispersion of sender	Approx. 1.4° (SR = max.),										
Angle of dispersion of receiver	Approx. 4.5° (SR = 1/2 max.)										
Supply voltage V_S	10 ... 30 V DC ²⁾										
Ripple ³⁾	≤ 10%										
Current consumption ⁴⁾	≤ 20 mA										
Switching outputs	Q: PNP										
	Q: NPN										
Output current I _A max.	≤ 100 mA										
Switching mode	Light-/Dark-switching selectable ⁵⁾										
Response time ⁶⁾	≤ 2.0 ms										
Switching frequency max. ⁷⁾	250/s										
Connection types											
Cable ⁸⁾ sender VS 12-2	PVC, 2 m, 2 x 0.14 mm ² , Ø 3.75 mm										
Cable ⁸⁾ receiver VE 12-2	PVC, 2 m, 4 x 0.14 mm ² , Ø 3.75 mm										
Plug	M12, 4-pin										
VDE protection class⁹⁾	□										
Circuit protection¹⁰⁾	A, B, C, D										
Enclosure rating	IP 67										
Ambient temperature T_A	Operation - 25 °C ... + 70 °C										
	Storage - 25 °C ... + 70 °C										
Weight	With cable VS and VE each approx. 54 g										
	With plug VS and VE each approx. 18 g										
Housing material	Housing: Nickel-coated brass/PA										
	Optics: PC										

- 1) Average service life 100,000 h at T_A = + 25 °C
- 2) Limit values
- 3) May not exceed or fall short of V_S tolerances
- 4) Without load
- 5) L/D switching type control line
L/D = open (not assigned) dark-switching D.ON
L/D = + V_S: light-switching L.ON
L/D = 0 V: dark-switching D.ON
- 6) Signal transit time with resistive load
- 7) With light/dark ratio 1:1
- 8) Do not bend below 0 °C
- 9) Reference voltage 50 V DC
- 10) A = V_S connections reverse-polarity protected
B = Inputs and output reverse-polarity protected
C = Interference pulse suppression
D = Outputs overload and short-circuit protected

Scanning range and operating reserve

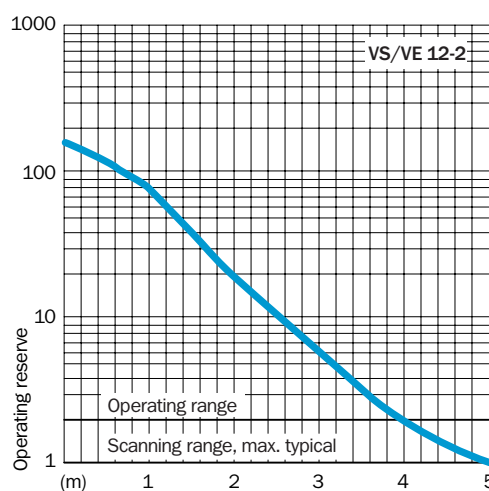
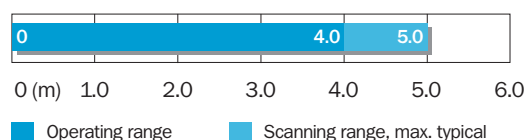

Order information

Type ¹¹⁾	Order no. ¹¹⁾
VS/VE 12-2P 132	6 026 223
VS/VE 12-2P 430	6 026 224
VS/VE 12-2N 132	6 026 221
VS/VE 12-2N 430	6 026 222

¹¹⁾ The order no. contains transmitter and receiver (= pair).