



Flexi Soft

THE CLEVER SAFETY CONTROLLER THAT UNITES ADVANTAGES

Safety controllers

SICK
Sensor Intelligence.

WITH Flexi Soft YOU ARE FIRMLY IN CONTROL

SICK is able to draw on over 65 years of experience when developing its safety solutions for personal protection – and since 2008, Flexi Soft has been an integral part of SICK’s portfolio of intelligent safety solutions.

With more than a million modules sold worldwide, Flexi Soft is one of the best-selling safety controllers in industrial safety technology. Many users are already enjoying the benefits of Flexi Soft. And what about you? When will you take control of your safety solution from SICK?



Adapt networked safety functions quickly and flexibly

- With Flexi Line, the safe controller networking from Flexi Soft → See “Safe networking” on page 11

Cost-effective modular options for expanding inputs and outputs

- With digital I/O modules (XTIO, XTDI, XTDS, STIO)
 - Analog current sensors can also be integrated into the Flexi Soft safety controller with the ANAO analog input module
 - Safely detect speed as well as position with the MOCO and the MOC1
- See “Safe drive monitoring” on page 12



NETWORKING

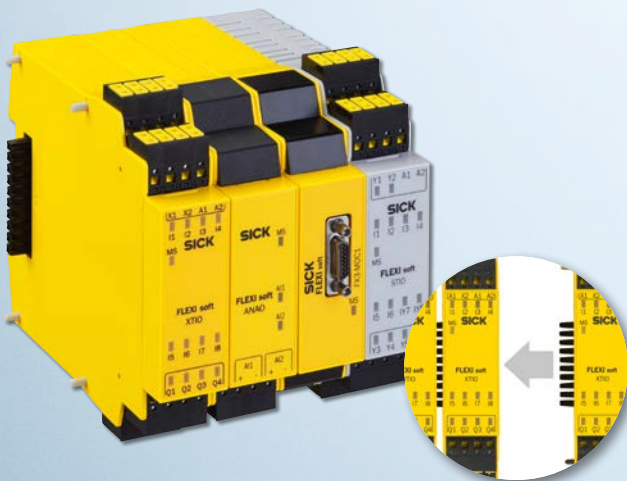

MODULAR

All modules can be connected together easily.



“The major benefits of SICK are its broad range of products and the new developments that they are bringing to the market which helps put us ahead of competitors.”

Ellis Brown, Electrical Design, JKSP Services Ltd.

Continuous diagnostics via the automation level right up to the cloud

- With gateways for CANopen, EtherCAT®, EtherNet/IP, Modbus® TCP, PROFIBUS DP, PROFINET, DeviceNet™, and CC-Link
- See “Flexi Soft ready for Industry 4.0” on page 8



Advanced functions for intelligent SICK product combinations

- ACR – automatic configuration recovery
- EFI – enhanced function interface
- See “Advanced sensor functions” on page 9

DIAGNOSTICS



SERIES CONNECTION

Connect sensors in series without compromising on the safety level

- Cascade switches and sensors safely with diagnostic support thanks to Flexi Loop
- See “Safe series connection” on page 10



INTELLIGENCE

CLEVER PROJECT PLANNING

Working with the Flexi Soft Designer software is ingeniously simple and intuitive. The user-friendly interface removes the barriers between the real machine and the project planning at your desk, ensuring efficient engineering. In this way, the software plays a key role in terms of communication and automation, without any additional costs or licenses.



1

Hardware configurator via drag and drop

Quick and easy selection and configuration of the hardware components via the intuitive user interface.

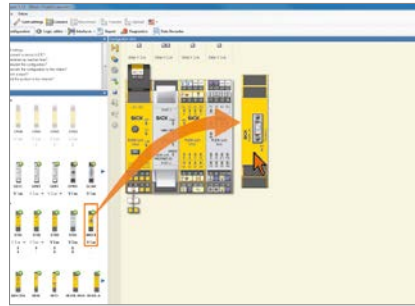

2

Logic editor with simulation mode

Choose from the full range of logic blocks as well as other application-specific function blocks and check your logic right from your desk with the integrated simulation mode.

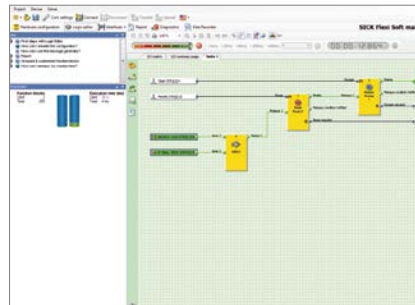

✓ 3

Documentation and diagnostics

- Extensive multilingual documentation
- Wiring plan for simplified installation
- Integrated data recorder provides support during commissioning
- Versatile diagnostic options

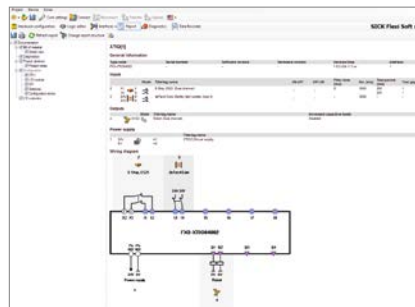

SIMPLE PROJECT PLANNING AT YOUR DESK

FAST COMMISSIONING AND DIAGNOSTICS IN THE FIELD



YouTube

→ www.youtube.com/user/SICKSensors

🔍 Flexi Soft Designer

TUTORIAL

Free software download

→ www.sick.com/FSD

SOFTWARE

INTELLIGENTLY APPLIED

Flexi Soft provides the basis for highly efficient safety solutions in many industries and application areas. The priority is always to align the solution perfectly with the customer's requirements while also reducing costs.



Automated guided vehicles – protective field switching via steering angle detection.

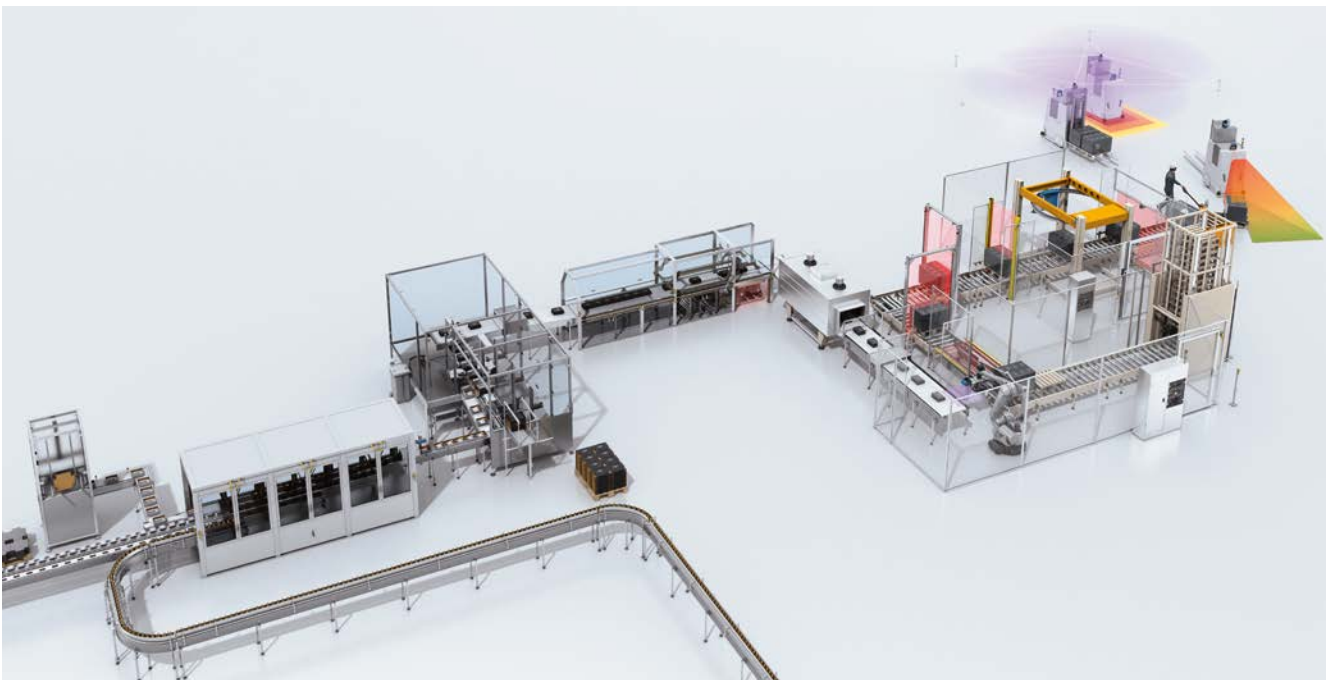

Packaging plants – safe networking of machine modules.



“Working with SICK, we have been able to design projects completely around SICK products rather than using a range of manufacturers.”

Ellis Brown, Electrical Design, JKSP Services Ltd.



Information on the subject of functional safety can be found at

→ www.sick.com/safetyiq

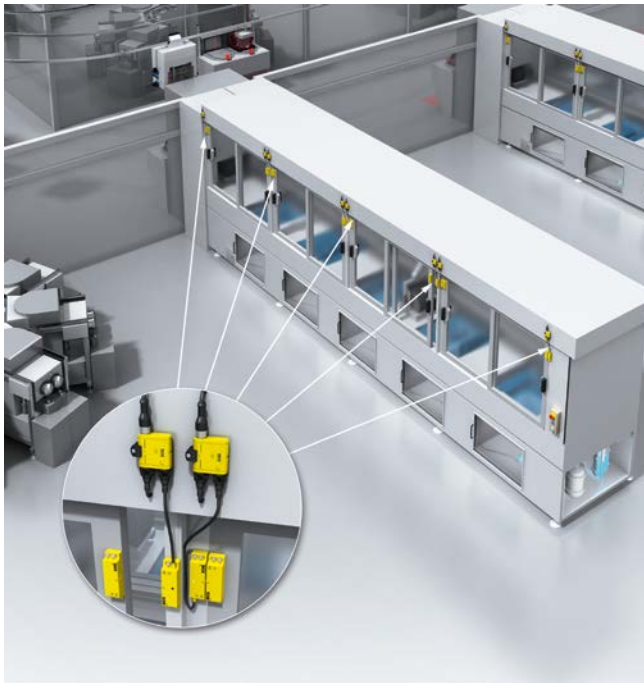

PCB manufacturing – safe series connection.



Final packaging – protection of a film winder.



Safe Robotics – pressure monitoring in the gripper module.

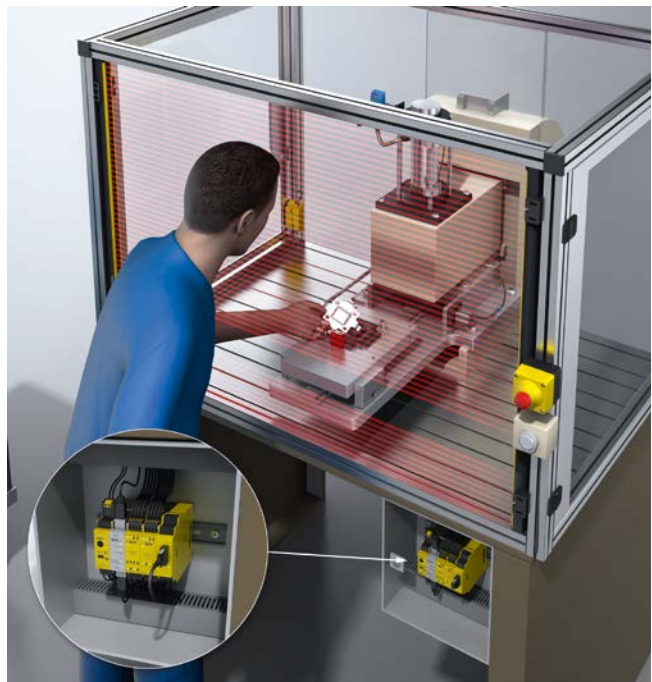

Small presses – differentiating between dangerous and safe movements.

SUPERIORITY RIGHT UP TO THE CLOUD

Fieldbus independence, data forwarding, and the intelligent combination of SICK products: Flexi Soft controls system solutions packed full of functionality and possibilities.

Flexi Soft ready for Industry 4.0

Supports targeted remote maintenance operations and predictive maintenance concepts

Connection via a multitude of industry-standard fieldbus gateways

Enables information to be used in the cloud as well

From the safety laser scanner to the emergency stop pushbutton: Provision of process data for diagnostic purposes in higher automation levels

4 INDUSTRY 4.0 READY



“Due to the increased complexity of our safety systems and the limitations of other products on the market we started working with SICK and using the SICK Flexi Soft safety controller.”

Phil Newman, Automation Manager, DH Industries Limited

ACR – fast device replacement thanks to automatic loading of the overall configuration

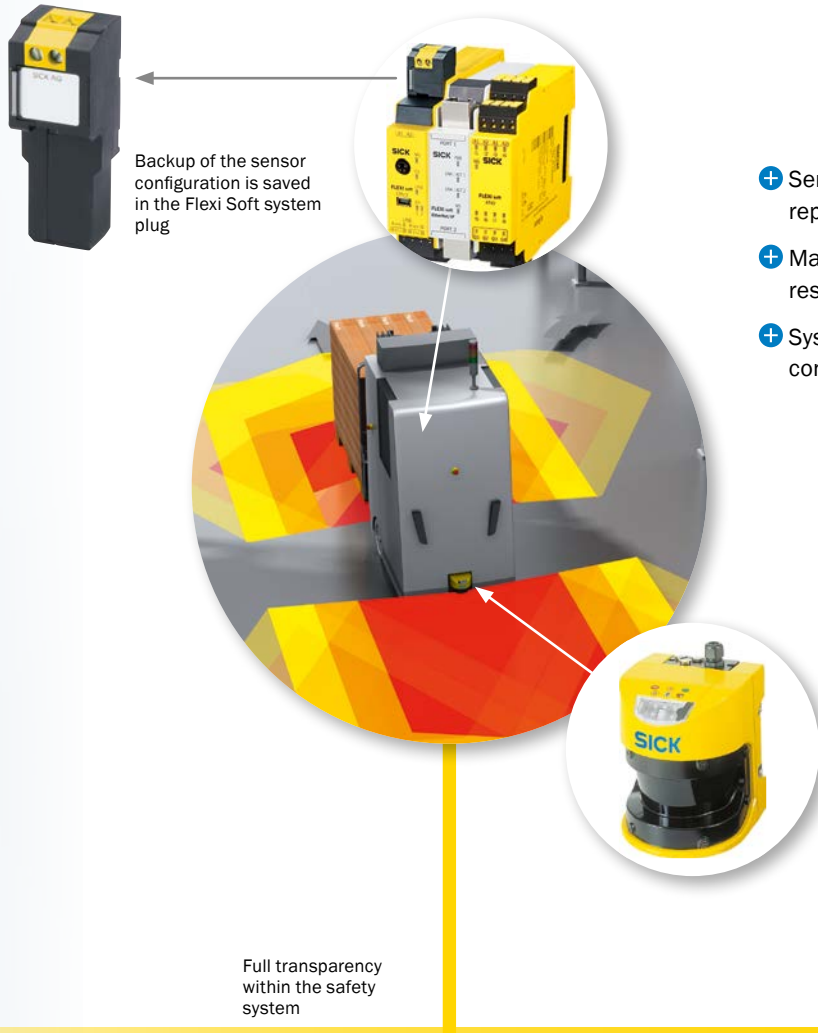

- + Sensor can be replaced without reprogramming
- + Makes it quicker and easier to resume operation
- + System integrity of sensor configuration is ensured

EFI – interface for clever combinations with added intelligence

- Simultaneous protective field monitoring + A single protective device can monitor several hazardous areas simultaneously and independently
- Protective field switching + Flexible and fast adaptation to the relevant machine or vehicle condition
- Operating mode switching + Rapid switching between different sensor configurations

CLEVERLY CONNECTED IN SERIES

Flexi Loop is the solution for connecting safety switches and safety sensors in series within a machine and offers more diagnostics options than conventional series connection. This prevents unnecessary downtime and avoids costs for maintenance and repairs. The quick and easy commissioning also saves time – and therefore money. Furthermore, the highest possible safety level is maintained for series connections by preventing the possibility of fault masking.

Monitoring of the entire series connection

- + Simple configuration and fast wiring save time and money
- + The highest possible safety level is maintained
- + Detailed status information about the connected sensors for rapid field diagnostics



“We use the Flexi Loop systems to break down our safety systems into smaller and more controllable systems, giving us greater control and allowing us to find faults more quickly.”

Phil Newman, Automation Manager, DH Industries Limited

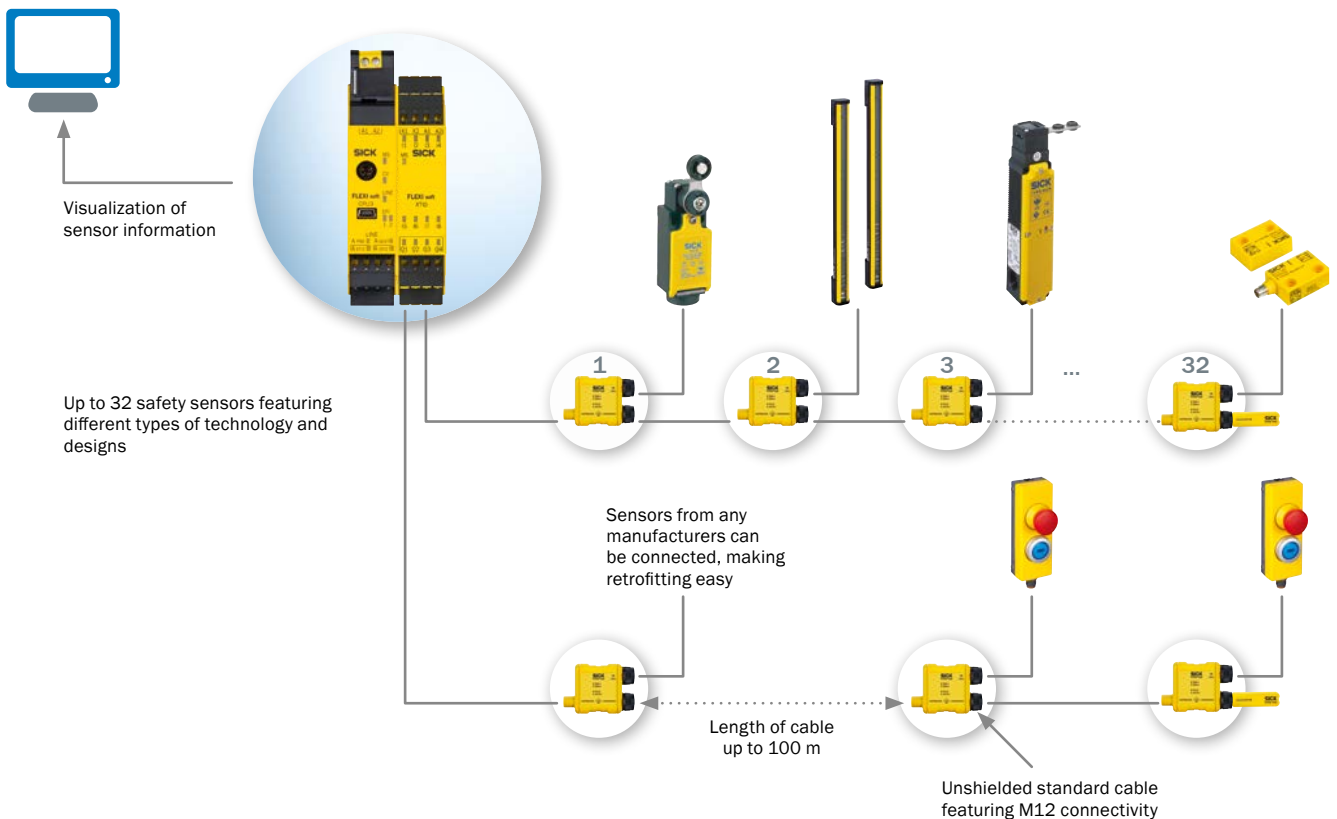

YouTube

→ www.youtube.com/user/SICKSensors

🔍 Flexi Loop

→ www.sick.com/safe-series-connection

▶ VIDEO

▶ TUTORIAL

☰ PRINT

🌐 WEB

OUTSTANDING NETWORKING

Flexi Line is responsible for safe controller networking in the Flexi Soft product family. It enables service-friendly replacement and makes it easy to expand plants, as there is no addressing required even if stations are added or removed. With up to 32 Flexi Soft stations, the machine structure can be mapped consistently and efficiently.

Extensive flexibility for modular machine concepts

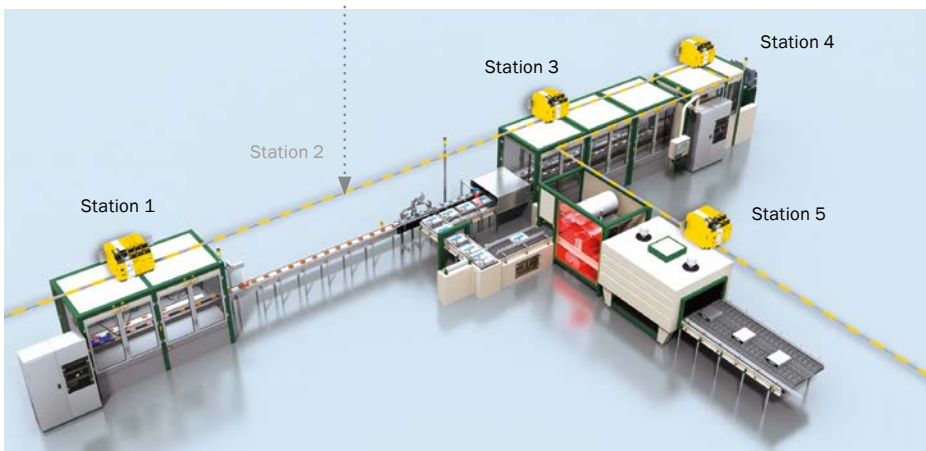
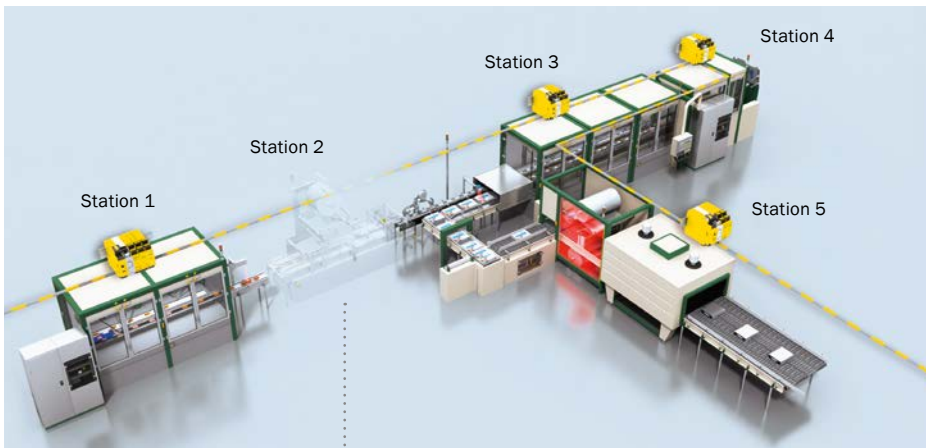

1. CHANGE

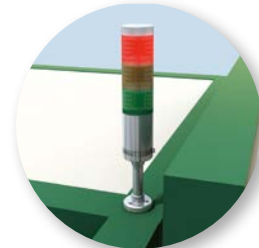

The machine has to be adapted.

2. TEACH-IN



(Re)configuration is carried out via a teach-in switch.

3. DONE

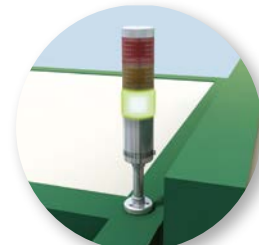

YouTube

→ www.youtube.com/user/SICKSensors

Flexi Line



→ <http://www.sickinsight-online.com>

More productivity at every stage



HAZARD-FREE IN THE HAZARDOUS AREA

Conventional safety solutions normally stop a machine completely when a person enters a hazardous area. The resulting machine downtime always reduces productivity significantly. With Safe Motion Control, SICK is putting an end to the either/or decision between protecting personnel or ensuring efficiency.

The Flexi Soft Motion Control modules monitor machine or drive movements by detecting the speed or position – regardless of whether the movements are linear or rotative.



Detection of rotative movements on an automated guided vehicle.

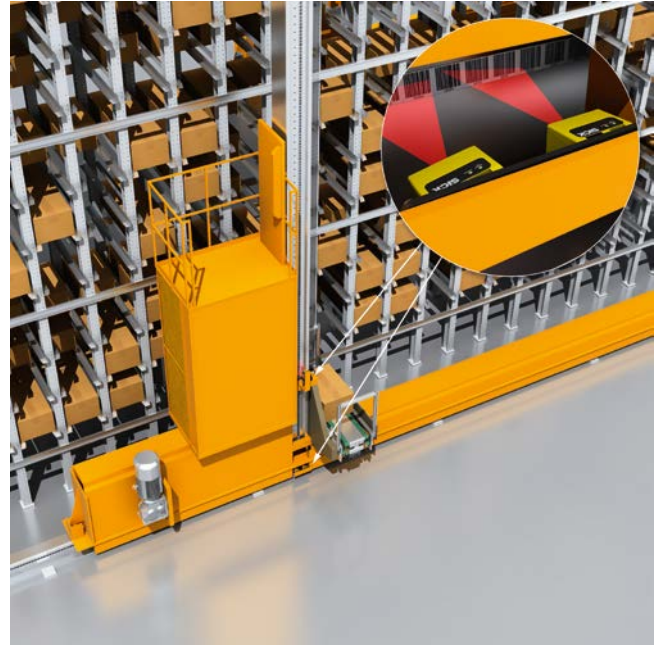

Detection of linear movements on a storage and retrieval system.

The benefits of SICK Safe Motion Control at a glance



+ Complete solutions from a single source

Products, services, and expertise in the field of safety guarantee future-proof success.

+ Increased productivity

By avoiding unintended shutdowns and shortening cycle times through continuous monitoring of the machine movements.



+ Cost benefit

Thanks to reduced implementation and installation work as a result of coordinated safety components from SICK.

+ Simplified certification process for plants

Safety components or complete safety solutions from SICK have already been certified by external bodies.





“Implementing the Flexi Soft MOC in our vehicles in conjunction with S300 laser scanners enables us to adapt the protective fields so that they are optimized for the ambient conditions in the plant, regardless of the geometry of the vehicle or drive.”

Wolfgang Holl, DS Automotion GmbH

Examples of functional safety with Safe Motion Control



- i** Machine movement is reduced to a safe speed

- !** SLS



- +** Efficient machine adjustment, fitting, and maintenance



- i** Differentiation between dangerous and safe machine movements

- !** SCA, SDI, SLP, SLS

- +** Reduced downtime, increased productivity



- i** Safe interaction between people and robots

- !** SLP, SLS, SS1, SS2, SSM

- +** Human-robot collaboration possible



- i** Safety doors, covers, and flaps can be opened as soon as the machine standstill is detected

- !** SS1, SS2

- +** Rapid access saves time

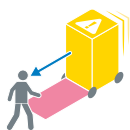

- i** Speed of automated guided vehicle is reduced when approaching a person or object

- !** SDI, SLS, SS1, SS2, SSM

- +** Higher speeds, safety when approaching people



- i** Speed of the automated guided vehicle is adapted according to the curve radius

- !** SLP, SLS, SS1, SS2, SSM

- +** Faster cornering

SCA = safe cam; SDI = safe direction; SLP = safely limited position; SLS = safely limited speed; SS1 = safe stop 1; SS2 = safe stop 2; SSM = safe speed monitor.



YouTube

→ www.youtube.com/user/SICKSensors

🔍 Drive Monitor

→ www.sick.com/safe-motion-control



VIDEO



TUTORIAL



PRINT



WEB

THE SOFTWARE-PROGRAMMABLE SAFETY CONTROLLER



Product description

The Flexi Soft safety controller can be programmed via software. Thanks to the modular hardware platform, Flexi Soft provides a tailored and efficient solution for a whole host of safety applications. A wide range of modules are available: main modules, gateways, digital and analog input/output modules, Motion Control modules, as well as relay modules. The license-free Flexi Soft Designer

configuration software enables intuitive programming, rapid commissioning, and continuous diagnostics down to the automation level. Functions to enable safe controller networking, a safe sensor cascade, or safe drive monitoring reduce costs and boost productivity. A whole host of additional functions means that Flexi Soft is able to bridge the gap to SICK's system solutions.

At a glance

- Safety controller with modular hardware platform
- Configuration saved in the system plug
- Safe controller networking with Flexi Line
- Safe sensor cascade with Flexi Loop
- Safe drive monitoring
- Flexi Soft Designer license-free configuration software

Your benefits

- Modular adaptation to the particular requirement means optimum scalability and therefore cost savings
- Intuitive configuration software featuring comprehensive functions for straightforward engineering
- Rapid verification of the safety application: The configuration software provides documentation and a wiring diagram
- The main module's diagnostics interfaces and the configuration storage facility in the system plug enable rapid commissioning, component replacement, and troubleshooting, resulting in minimum downtimes



Additional information

Detailed technical data 15
 Ordering information24
 Dimensional drawings 26
 Accessories..... 30

→ www.sick.com/Flexi_Soft

For more information, simply enter the link or scan the QR code and get direct access to technical data, CAD design models, operating instructions, software, application examples, and much more.



Detailed technical data

General data

System construction	Modular 1 system plug 1 main module 0 ... 2 gateways 0 ... 12 expansion modules 0 ... 8 relay modules
Configuration method	Via software
Configuration software	Flexi Soft Designer
Fieldbus, industrial network	CANopen, EtherCAT®, EtherNet/IP™, Modbus TCP, PROFIBUS DP, PROFINET, DeviceNet™, CC-Link
Type of fieldbus integration	Via gateway

Main modules

Safety-related parameters

	FX3-CPU0	FX3-CPU1	FX3-CPU2	FX3-CPU3
Safety integrity level	SIL3 (IEC 61508) SILCL3 (EN 62061)			
Category	Category 4 (EN ISO 13849)			
Performance level	PL e (EN ISO 13849)			
PFH₀ (mean probability of a dangerous failure per hour)	1.07 x 10 ⁻⁹ (EN ISO 13849)	1.69 x 10 ⁻⁹ (EN ISO 13849)		1.69 x 10 ⁻⁹ (EN ISO 13849) 0.4 x 10 ⁻⁹ (EN ISO 13849) ¹⁾
T_M (mission time)	20 years (EN ISO 13849)			

¹⁾ Applies for a main module FX3-CPU3 that is used exclusively for routing information via Flexi Line.

Functions

	FX3-CPU0	FX3-CPU1	FX3-CPU2	FX3-CPU3
Safe SICK device communication via EFI	-	✓		
Safe networking				
Flexi Link	-	✓		
Flexi Line	-			✓
Automatic Configuration Recovery (ACR)	-		✓	

Interfaces

	FX3-CPU0	FX3-CPU1	FX3-CPU2	FX3-CPU3
System connection	System plug ¹⁾			
Number of EFI interfaces	0	2		
Flexi Line connection	-			✓
Connection type	Spring terminals			
Configuration and diagnostics interface	RS-232 (female connector M8, 4-pin)			RS-232 (female connector M8, 4-pin) USB

¹⁾ The system plug has to be ordered separately. For details, see "Accessories".

Electrical data

Protection class	III (EN 61140)
Type of voltage supply	PELV or SELV ¹⁾
Supply voltage V _s	24 V DC (16.8 V DC ... 30 V DC)
Internal power consumption	≤ 2.5 W
Overvoltage category	II (EN 61131-2)
Switch-on time	≤ 18 s

¹⁾ The current of the power supply that powers the main unit must be limited to a maximum of 4 A, either through the power supply itself or a fuse.

Mechanical data

	FX3-CPU0	FX3-CPU1	FX3-CPU2	FX3-CPU3
Dimensions (W x H x D)	22.5 mm x 96.5 mm x 120.6 mm			
Weight	111 g (± 5 %)	119 g (± 5 %)		133 g (± 5 %)

Ambient data

Enclosure rating	IP20 (EN 60529)
Ambient operating temperature	-25 °C ... +55 °C
Storage temperature	-25 °C ... +70 °C
Air humidity	10 % ... 95 %, Non-condensing

Gateways

Interfaces

	FX0-GENT	FX0-GMOD	FX0-GPNT	FX0-GETC	FX0-GPRO	FX0-GCAN	FX0-GDEV	FX0-GCC
Fieldbus, industrial network	EtherNet/IP™	Modbus TCP	PROFINET	EtherCAT®	PROFI-BUS DP	CANopen	Device-Net™	CC-Link
Integrated Ethernet switch	3-port layer-2 managed switch with Auto-MDI-X for automatic detection of crossed Ethernet cable			-				
Data transmission rate	10 Mbit/s, 10Base-T 100 Mbit/s, 100Base-T autosensing				≤ 12.000 kbit/s ¹⁾	≤ 1.000 kbit/s ¹⁾	≤ 500 kbit/s ¹⁾	156 kbit/s 625 kbit/s 2,5 Mbit/s 5 Mbit/s 10 Mbit/s auto-sensing
Connection type	2 x female connector, RJ-45				1 x female connector, D-Sub, 9-pin	1 x female connector, Open Style, 5-pin		Plug-in terminals

¹⁾ Depending on cable length.

Electrical data

	FX0-GENT	FX0-GMOD	FX0-GPNT	FX0-GETC	FX0-GPRO	FX0-GCAN	FX0-GDEV	FX0-GCC
Protection class	III (EN 61140)							
Voltage supply	Via FLEXBUS+							
Internal power consumption	≤ 2.4 W ¹⁾			≤ 3 W ¹⁾	≤ 1.6 W ¹⁾		≤ 1.4 W ¹⁾	

¹⁾ Via FLEXBUS+.

Mechanical data

	FX0-GENT	FX0-GMOD	FX0-GPNT	FX0-GETC	FX0-GPRO	FX0-GCAN	FX0-GDEV	FX0-GCC
Dimensions (W x H x D)	22.5 mm x 96.5 mm x 120.6 mm				22.5 mm x 96.5 mm x 126 mm	22.5 mm x 96.5 mm x 131 mm		22.5 mm x 96.5 mm x 20.6 mm
Weight	125 g (± 10 %)			150 g (± 10 %)			120 g (± 10 %)	

Ambient data

	FX0-GENT	FX0-GMOD	FX0-GPNT	FX0-GETC	FX0-GPRO	FX0-GCAN	FX0-GDEV	FX0-GCC
Enclosure rating	IP20 (EN 60529)							
Ambient operating temperature	-25 °C ... +55 °C							0 °C ... +55 °C
Storage temperature	-25 °C ... +70 °C							
Air humidity	10 % ... 95 %, Non-condensing							

Expansion modules – I/O modules

Safety-related parameters

	FX3-XTIO	FX3-XTDI	FX3-XTDS	FX0-STIO
Safety integrity level	SIL3 (IEC 61508) SILCL3 (EN 62061)			-
Category	Category 4 (EN ISO 13849)			-
Performance level	PL e (EN ISO 13849)			-
PFH₀ (mean probability of a dangerous failure per hour)	4.8 x 10 ⁻⁹ (EN ISO 13849) ¹⁾ 0.9 x 10 ⁻⁹ (EN ISO 13849) ²⁾	0.4 x 10 ⁻⁹ (EN ISO 13849)		-
T_M (mission time)	20 years (EN ISO 13849)			-

¹⁾ For single channel outputs.²⁾ For dual channel outputs.

Functions

	FX3-XTIO	FX3-XTDI	FX3-XTDS	FX0-STIO
Flexi Loop-compatible	✓			-
Fast shut-off	✓	-		
Fast shut-off time	8 ms	-		

Interfaces

	FX3-XTIO	FX3-XTDI	FX3-XTDS	FX0-STIO
Number of safety inputs	8			-
Number of non-safe inputs	-			6-8 ¹⁾
Number of test outputs	2	8	0-2	-
Number of safe outputs	4			
Number of non-safe outputs	-		4-6 ²⁾	6-8 ¹⁾
Connection type	Spring terminals			

¹⁾ The FX0-STIO features 6 non-safe inputs and outputs each. In addition, connections IY7 and IY8 as well as the non-safe input can also be used as non-safe outputs.²⁾ In addition, test outputs XY1 and XY2 can be used as additional non-safe outputs.

Electrical data

	FX3-XTIO	FX3-XTDI	FX3-XTDS	FX0-STIO
Protection class	III (EN 61140)			
Voltage supply	Via FLEXBUS+			
Internal power consumption	≤ 2.2 W ¹⁾	≤ 2 W ¹⁾	≤ 1.5 W ¹⁾	≤ 1.5 W ²⁾
Inputs				
Input voltage HIGH	13 V DC ... 30 V DC			
Input voltage LOW	-5 V DC ... 5 V DC			
Input current HIGH	2.4 mA ... 3.8 mA			
Input current LOW	-2.5 mA ... 2.1 mA			
Test outputs				
Voltage supply	Via FLEXBUS+			-
Type of output	PNP semiconductors, short-circuit protected			-
Test pulse generator	2			-
Output voltage HIGH	15 V DC ... 30 V DC			-
Output current	≤ 120 mA ³⁾			-
Outputs				
Voltage supply	Via A1, A2	-	Via A1, A2	
Supply voltage	24 V DC (16.8 V DC ... 30 V DC)	-	24 V DC (16.8 V DC ... 30 V DC)	
Type of supply voltage	PELV or SELV ⁴⁾	-	PELV or SELV ⁴⁾	
Type of output	PNP semiconductors, short-circuit protected	-	PNP semiconductors, short-circuit protected	
Output voltage HIGH	16 V DC ... 30 V DC	-	16 V DC ... 30 V DC	
Output current	≤ 2 A	-	≤ 500 mA	

¹⁾ Via FLEXBUS+, without streams at test outputs.

²⁾ Via FLEXBUS+.

³⁾ On each of the two test pulse generators. This makes max. 8 testable sensor cascades per module possible with max. 30 mA each.

⁴⁾ The current of the power supply that powers the module must be limited to a maximum of 4 A, either through the power supply itself or a fuse.

Mechanical data

	FX3-XTIO	FX3-XTDI	FX3-XTDS	FX0-STIO
Dimensions (W x H x D)	22.5 mm x 96.5 mm x 120.6 mm			
Weight	164 g (± 5 %)	139 g (± 5 %)		

Ambient data

Enclosure rating	IP20 (EN 60529)
Ambient operating temperature	-25 °C ... +55 °C
Storage temperature	-25 °C ... +70 °C
Air humidity	10 % ... 95 %, Non-condensing

Expansion modules – Analog input module

Safety-related parameters

Safety integrity level	SIL3 (IEC 61508) SILCL3 (EN 62061)
Category	Category 4 (EN ISO 13849)
Performance level	PL e (EN ISO 13849)
PFH_D (mean probability of a dangerous failure per hour)	0.166 x 10 ⁻⁹
T_M (mission time)	20 years (EN ISO 13849-1)

Functions

Threshold monitoring	✓
Signal range detection	✓

Interfaces

Number of analog inputs	2
Connection type	Spring terminals

Electrical data

Protection class	III (EN 61140)
Voltage supply	Via FLEXBUS+
Internal power consumption	≤ 2 W ¹⁾
Analogue inputs	
Input voltage	≤ 30 V DC
Input current	≤ 30 mA
Current measuring range	4 mA ... 20 mA
Current input measuring range	3.5 mA ... 20.5 mA ^{2) 3)}
Input resistance	50 Ω

¹⁾ Via FLEXBUS+, without current on test signal outputs.

²⁾ Threshold below which a sensor fault is assumed. A max. deviation of 1% (full scale value) gives a tolerance range of 3.3 mA to 3.7 mA.

³⁾ Threshold above which a sensor fault is assumed. A max. deviation of 1% (full scale value) gives a tolerance range of 20.3 mA to 20.7 mA.

Mechanical data

Dimensions (W x H x D)	22.5 mm x 96.5 mm x 120.6 mm
Weight	117 g (± 5 %)

Ambient data

Enclosure rating	IP20 (EN 60529)
Ambient operating temperature	-25 °C ... +55 °C
Storage temperature	-25 °C ... +70 °C
Air humidity	10 % ... 95 %, Non-condensing

Expansion modules – Motion Control modules

Safety-related parameters

For axes with two encoders (any combination of sine-cosine, TTL, HTL 24 V, MTL 12 V, RS-422, SSI)

	FX3-MOC0	FX3-MOC1
Safety integrity level	SIL3 (IEC 61508) SILCL3 (EN 62061)	
Category	Category 4 (EN ISO 13849)	
Performance level	PL e (EN ISO 13849)	
PFH_D (mean probability of a dangerous failure per hour)	5.0 * 10 ⁻⁹	
Minimum movement for error detection	≥ selected tolerance limit for the function block used for the cross check, e.g. speed cross check, At least 1 x within 24 h	≥ selected tolerance limit of the function block used for cross check, e.g., position cross check, At least 1 x within 24 h
T_M (mission time)	20 years (EN ISO 13849)	

For axes with one sine-cosine encoder and sin/cos analog voltage monitoring activated

Safety integrity level	SIL2 (IEC 61508) SILCL2 (EN 62061)
Category	Category 3 (EN ISO 13849)
Performance level	PL d (EN ISO 13849)
PFH_D (mean probability of a dangerous failure per hour)	6.0 * 10 ⁻⁹
Minimum movement for error detection	≥ 1 Sin/Cos period, At least 1 x within 24 h
T_M (mission time)	20 years (EN ISO 13849)

Functions

	FX3-MOC0	FX3-MOC1
Drive safety functions	Safe stop 1 (SS1) Safe stop 2 (SS2) Safe operating stop (SOS) Safe speed monitoring (SSM) Safely-limited speed (SLS) Safe direction of motion (SDI) Safe brake control (SBC)	Safe stop 1 (SS1) Safe stop 2 (SS2) Safe operating stop (SOS) Safe speed monitoring (SSM) Safely-limited speed (SLS) Safe direction (SDI) Safe brake control (SBC) Safe cam (SCA) Safely-limited position (SLP)

Interfaces

Encoder interface	A/B incremental encoder, TTL A/B incremental encoder, HTL 12 V or 24 V A/B incremental encoder, RS-422 Sin/cos encoder SSI encoder (master / listener)
Connection type	Male connector, Micro D-Sub, 15-pin
Data interface	Internal bus (FLEXBUS+)

Electrical data

Protection class	III (EN 61140)
Voltage supply	Via FLEXBUS+
Internal power consumption	$\leq 2.5 \text{ W}^{1)}$
A/B incremental encoder, TTL, 2 outputs	
Differential input voltage HIGH	5 V (2 V ... 5.3 V) ²⁾
Differential input voltage LOW	0 V (-0.3 V ... 0.8 V) ²⁾
Input voltage	-5 V ... 10 V ³⁾
Input frequency	$\leq 300 \text{ kHz}$
Input resistance	$\geq 35 \text{ k}\Omega$
A/B incremental encoder, TTL, 2 pairs of outputs	
Differential input voltage HIGH	5 V (1.2 V ... 5.6 V) ²⁾
Differential input voltage LOW	-5 V (-5.6 V ... -1.2 V) ²⁾
Input voltage	-5 V ... 10 V ³⁾
Input frequency	$\leq 300 \text{ kHz}$
Input resistance	$\geq 35 \text{ k}\Omega$
A/B incremental encoder, HTL 12 V, 2 outputs	
Differential input voltage HIGH	12 V (6.5 V ... 15 V) ²⁾
Differential input voltage LOW	0 V (-1 V ... 2.5 V) ²⁾
Input voltage	-5 V ... 20 V ³⁾
Input frequency	$\leq 300 \text{ kHz}$
Input resistance	$\geq 35 \text{ k}\Omega$
A/B incremental encoder, HTL 12 V, 2 pairs of outputs	
Differential input voltage HIGH	12 V (4 V ... 15 V) ²⁾
Differential input voltage LOW	-12 V (-15 V ... -4 V) ²⁾
Input voltage	-5 V ... 20 V ³⁾
Input frequency	$\leq 300 \text{ kHz}$
Input resistance	$\geq 35 \text{ k}\Omega$
A/B incremental encoder, HTL 24 V, 2 outputs	
Differential input voltage HIGH	24 V (13 V ... 30 V) ²⁾
Differential input voltage LOW	0 V (-3 V ... 5 V) ²⁾
Input voltage	-10 V ... 40 V ³⁾
Input frequency	$\leq 300 \text{ kHz}$
Input resistance	$\geq 35 \text{ k}\Omega$
A/B incremental encoder, HTL 24 V, 2 pairs of outputs	
Differential input voltage HIGH	24 V (8 V ... 30 V) ²⁾
Differential input voltage LOW	-24 V (-30 V ... -8 V) ²⁾
Input voltage	-10 V ... 40 V ³⁾
Input frequency	$\leq 300 \text{ kHz}$
Input resistance	$\geq 35 \text{ k}\Omega$

¹⁾ Via FLEXBUS+, without current on test signal outputs.²⁾ Voltage between ENC_x_y+ and ENC_x_y-.³⁾ Voltage between ENC_x_y+ and ENC_0V and between ENC_x_y- and ENC_0V.⁴⁾ Peak to peak voltage between ENC_x_y+ and ENC_x_y-.

A/B incremental encoder, RS-422	
Differential input voltage HIGH	0.2 V ... 5 V ²⁾
Differential input voltage LOW	-5 V ... -0.2 V ²⁾
Input voltage	-7 V ... 7 V ³⁾
Input frequency	≤ 1,000 kHz
Input resistance	≥ 35 kΩ
Differential resistance	120 Ω (100 Ω ... 150 Ω)
Sin/cos encoder	
Differential input voltage	1 V (0.8 V ... 1.2 V) ⁴⁾
Input voltage	0 V ... 5 V ³⁾
Input frequency	≤ 120 kHz
Input resistance	1 kΩ (0.9 kΩ ... 1.1 kΩ)
Lower limit for vector length monitoring	0.5 V
Upper limit for vector length monitoring	1.5 V
SSI encoder	
Differential resistance	120 Ω (100 Ω ... 150 Ω)
Clock frequency	100 kHz ... 1,000 kHz
Cycle gaps between the data packages (monoflop time)	≥ 100 μs
Position data bits per frame	16 ... 62

¹⁾ Via FLEXBUS+, without current on test signal outputs.

²⁾ Voltage between ENC_{x_y+} and ENC_{x_y-}.

³⁾ Voltage between ENC_{x_y+} and ENC_OV and between ENC_{x_y-} and ENC_OV.

⁴⁾ Peak to peak voltage between ENC_{x_y+} and ENC_{x_y-}.

Mechanical data

Dimensions (W x H x D)	22.5 mm x 96.5 mm x 126 mm
Weight	120 g

Ambient data

Enclosure rating	IP20 (EN 60529)
Ambient operating temperature	-25 °C ... +55 °C
Storage temperature	-25 °C ... +70 °C
Air humidity	10 % ... 95 %, Non-condensing

Flexi Loop safe series connection

Find detailed technical data on → [page 34](#)

Relay modules

Safety-related parameters

	UE410-2R04	UE410-4R04	UE10-2FG3	UE12-2FG3
Safety integrity level	SIL3 (IEC 61508) SILCL3 (EN 62061)			
Category	Category 4 (EN ISO 13849)			
Performance level	PL e (EN ISO 13849)			
PFH_D (mean probability of a dangerous failure per hour)	1.2 x 10 ⁻⁹ ¹⁾ (EN ISO 13849)		7.0 x 10 ⁻¹⁰ (EN ISO 13849)	1.2 x 10 ⁻⁹ (EN ISO 13849)

¹⁾ I = 0.75 A, switching frequency = 1/h

Interfaces

	UE410-2R04	UE410-4R04	UE10-2FG3	UE12-2FG3
Number of control inputs	1 (B1)	2 (B1, B2)	1 (B1, B2)	
Number of enable current contacts	2 (13/14, 23/24)	4 (13/14, 23/24, 33/34, 43/44)	2 (13/14, 23/24)	
Number of signalling current contacts	1 (Y14)	2 (Y14, Y24)	0	
Number of contactor monitoring contacts	1 (Y1/Y2)	2 (Y1/Y2, Y3/Y4)	1 (Y1/Y2)	
Connection type	Plug-in spring terminals		Plug-in screw-type terminals	

Electrical data

	UE410-2R04	UE410-4R04	UE10-2FG3	UE12-2FG3
Protection class	III (EN 61140)		-	
Voltage supply	Via FLEXBUS+		Via B1, B2	
Internal power consumption	≤ 1.6 W	≤ 3.2 W	≤ 2 W	
Overvoltage category	II (EN 61131-2)			
Switching inputs				
Terminals	B1	B1, B2		
Input voltage	18 V DC ... 30 V DC		16.8 V DC ... 27.6 V DC	
Enable current contacts				
Terminals	13/14, 23/24	13/14, 23/24, 33/34, 43/44	13/14, 23/24	
Type of output	Potential-free NO contacts, positively guided			
Switching voltage	5 V AC/DC ... 253 V AC/DC		10 V AC/DC ... 250 V AC/DC	
Switching current	10 mA ... 6 A			
Signalling current contacts				
Terminals	Y14	Y14, Y24	-	
Type of output	NO contact, connected to internal 24 V DC, positively guided, current-limited			
Output voltage	16 V DC ... 30 V DC		-	
Output current	≤ 75 mA		-	
Contactor monitoring contacts				
Terminals	Y1/Y2	Y1/Y2, Y3/Y4	Y1/Y2	
Type of output	Potential-free NC contacts, positively guided			
Switching voltage	5 V AC/DC ... 253 V AC/DC		0.1 V AC/DC ... 60 V AC/DC	
Switching current	10 mA ... 6 A		1 mA ... 300 mA	

Mechanical data

	UE410-2R04	UE410-4R04	UE10-2FG3	UE12-2FG3
Dimensions (W x H x D)	22.5 mm x 96.5 mm x 120.6 mm		17.8 mm x 105.5 mm x 70.8 mm	
Weight	160 g (± 5 %)	186 g (± 5 %)	91 g (± 5 %)	

Ambient data

	UE410-2R04	UE410-4R04	UE10-2FG3	UE12-2FG3
Enclosure rating	IP20 (EN 60529)			
Ambient operating temperature	-25 °C ... +55 °C		0 °C ... +55 °C	
Storage temperature	-25 °C ... +70 °C		-25 °C ... +75 °C	

Ordering information

Main modules

Number of EFI interfaces	Flexi Link	Automatic Configuration Recovery (ACR)	Flexi Line	Protective coating	Type	Part no.
0	-	-	-	-	FX3-CPU000000	1043783
				✓ ¹⁾	FX3-CPU000010	1050615
2	✓	-	-	-	FX3-CPU130002	1043784
				✓ ¹⁾	FX3-CPU130012	1050616
		✓	-	-	FX3-CPU230002	1058999
				✓	FX3-CPU320002	1059305

¹⁾ with protective coating for more challenging ambient conditions (e.g., resistance to sulfur)

Gateways

Fieldbus, industrial network	Type	Part no.
EtherNet/IP™	FX0-GENT00000	1044072
Modbus	FX0-GMOD00000	1044073
PROFINET	FX0-GPNT00000	1044074
EtherCAT®	FX0-GETC00000	1051432
PROFIBUS DP	FX0-GPRO00000	1044075
CANopen	FX0-GCAN00000	1044076
DeviceNet™	FX0-GDEV00000	1044077
CC-Link	FX0-GCC100200	1085195

Expansion modules – I/O modules

Number of safety inputs	Number of non-safe inputs	Number of test outputs	Number of safe outputs	Number of non-safe outputs	Protective coating	Type	Part no.
8	-	2	4	-	-	FX3-XTI084002	1044125
					✓ ¹⁾	FX3-XTI084012	1050618
		8	-	-	-	FX3-XTDI80002	1044124
					✓ ¹⁾	FX3-XTDI80012	1050617
0-2	-	4-6	-	FX3-XTDS84002	1061777		
-	6-8	-	-	6-8	-	FX0-STI068002	1061778

¹⁾ with protective coating for more challenging ambient conditions (e.g., resistance to sulfur)

Expansion modules – Analog input module

Number of analog inputs	Type	Part no.
2	FX3-ANA020002	1051134

Expansion modules – Motion Control module

Description	Type	Part no.
Safe speed monitoring	FX3-MOC000000	1062344
Safe speed monitoring and safe position monitoring	FX3-MOC100000	1057833

Flexi Loop safe series connection

Find detailed technical data on → [page 34](#)

Relay modules

Number of enable current contacts	Number of signalling current contacts	Number of contactor monitoring contacts	Connection type	Protective coating	Type	Part no.
2	1	1	Plug-in spring terminals	-	UE410-2R04	6032677
4	2	2	Plug-in spring terminals	-	UE410-4R04	6032676
				✓ ¹⁾	UE410-4R0401	6053182
2	0	1	Plug-in screw-type terminals	-	UE10-2FG3D0	1043916
				-	UE12-2FG3D0	1043918

¹⁾ with protective coating for more challenging ambient conditions (e.g., resistance to sulfur)

Dimensional drawings (Dimensions in mm (inch))

FX3-CPU0

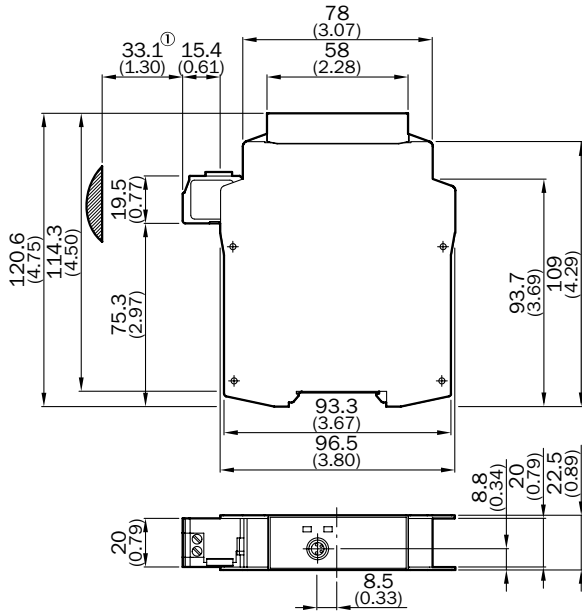

① Approximate connector range

FX3-CPU1, FX3-CPU2

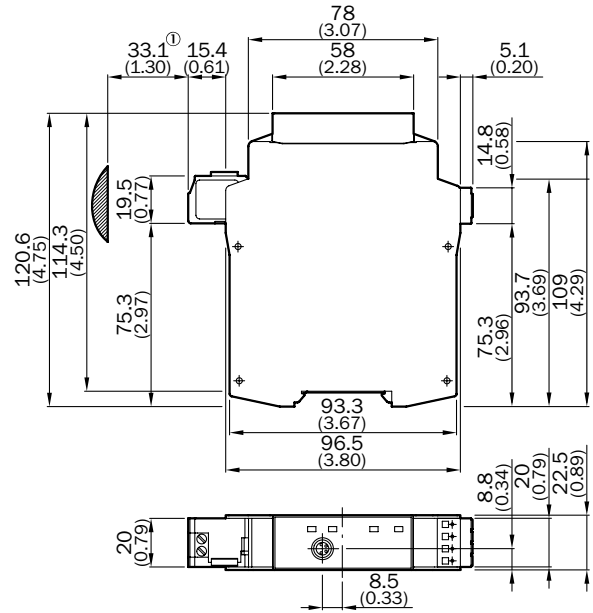

① Approximate connector range

CPU3

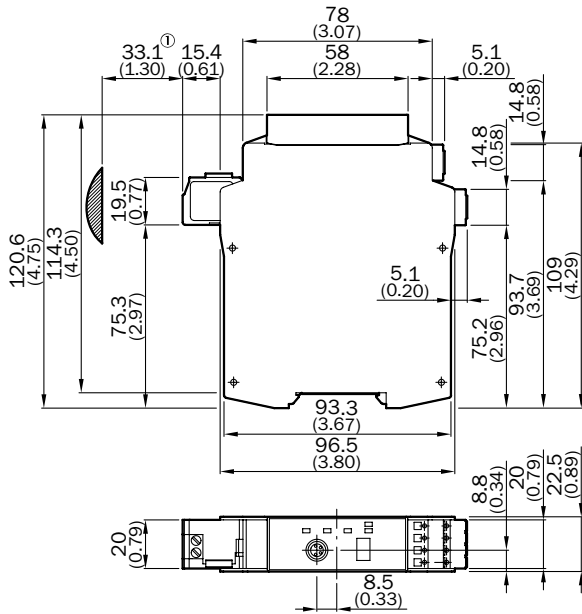

① Approximate connector range

FX0-GENT, FX0-GMOD, FX0-GPNT

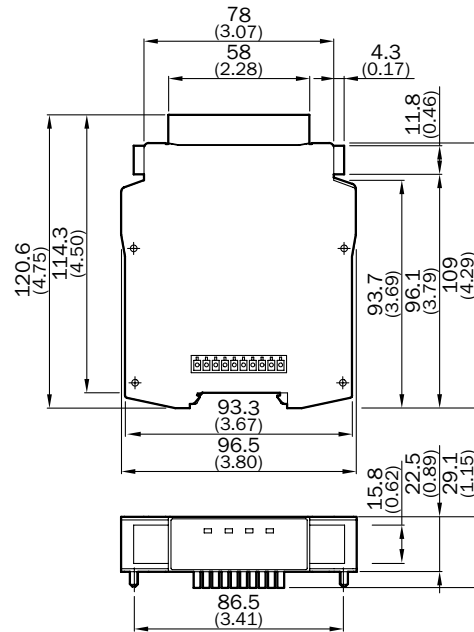

FX0-GETC

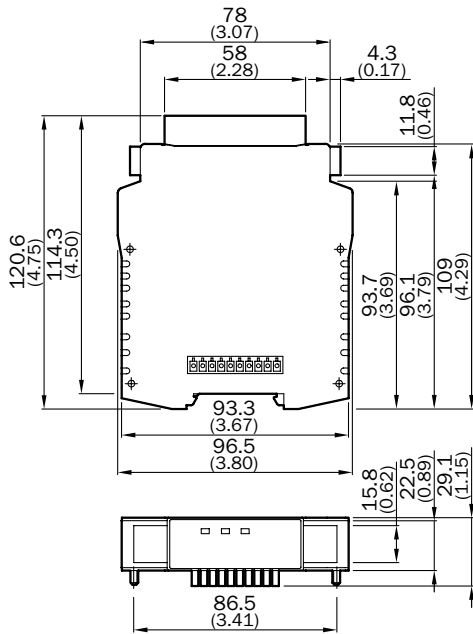

FX0-GPRO

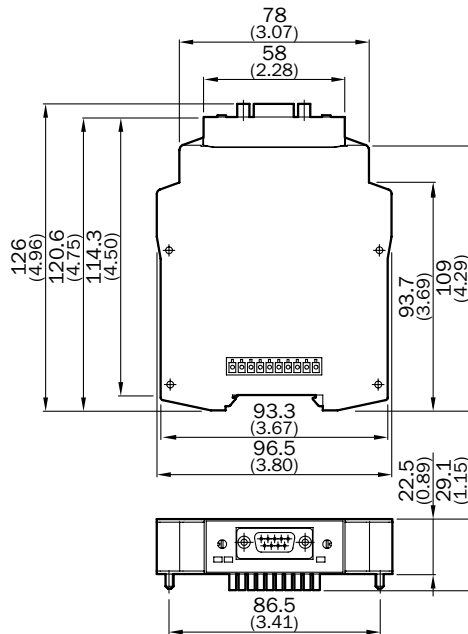

FX0-GCAN, FX0-GDEV

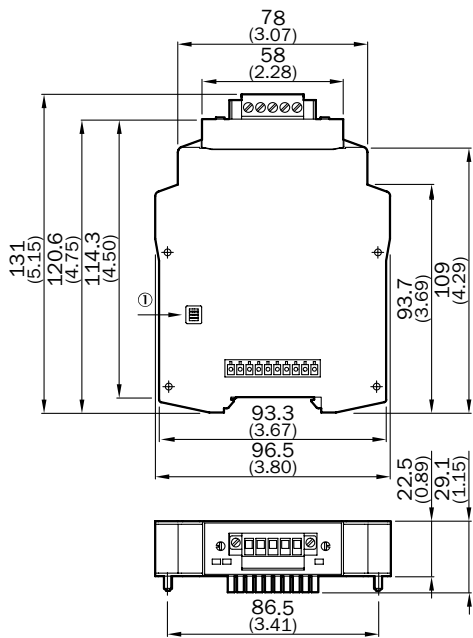

FX0-GCC

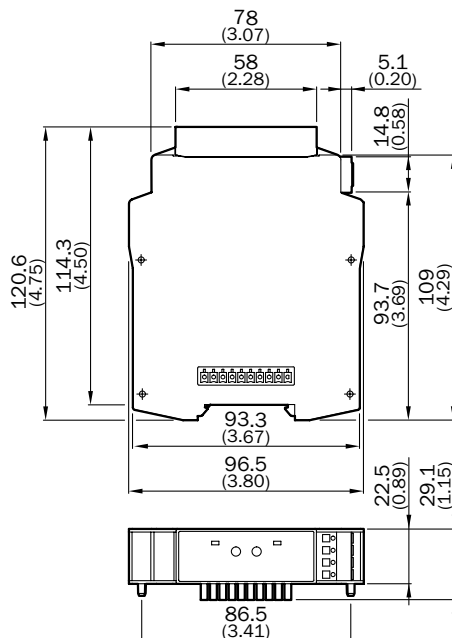

① On the rear

FX3-XTIO, FX3-XTDI

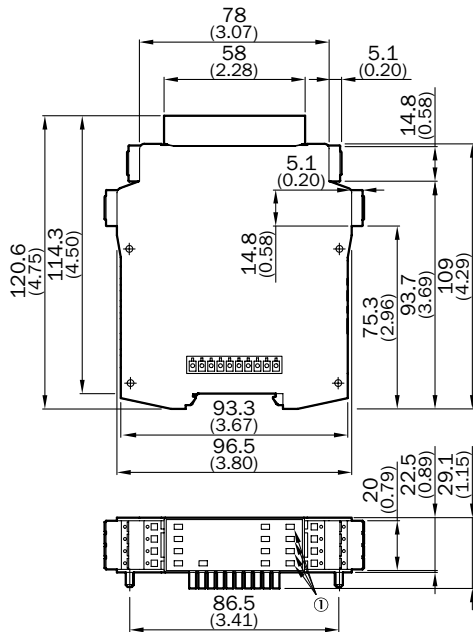

① Only valid for FX3-XTIO

FX3-XTDS, FX0-STIO

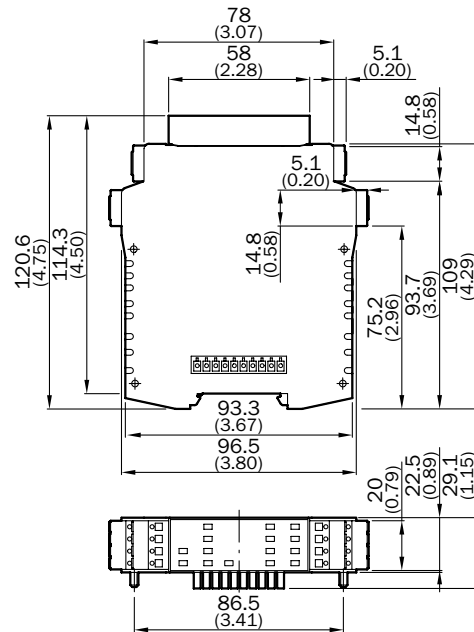

FX3-ANA0

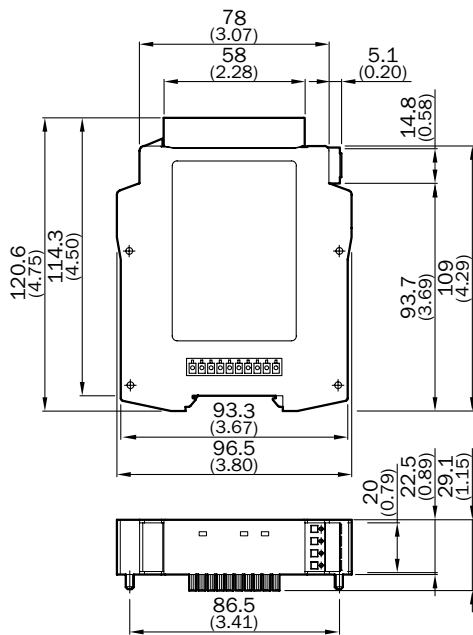

FX3-MOCO, FX3-MOC1

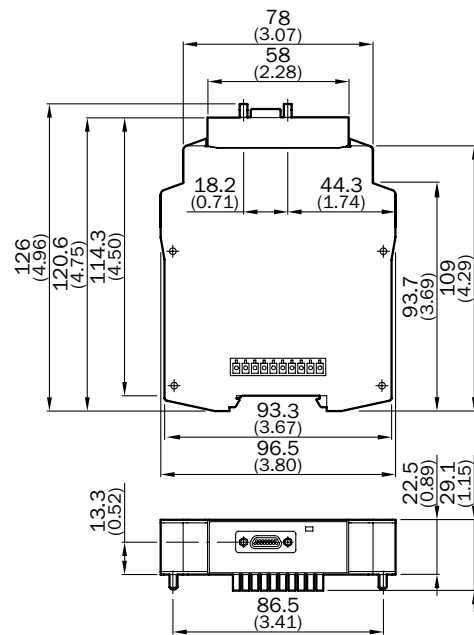

UE410-2R04, UE410-4R04

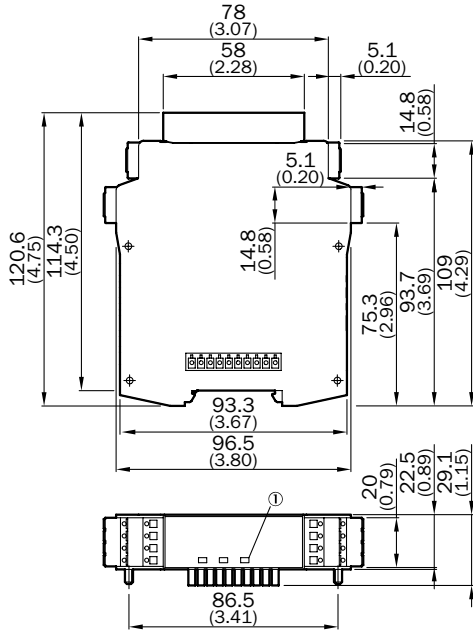

① Only valid for UE410-4R04

UE10-2FG3, UE12-2FG3

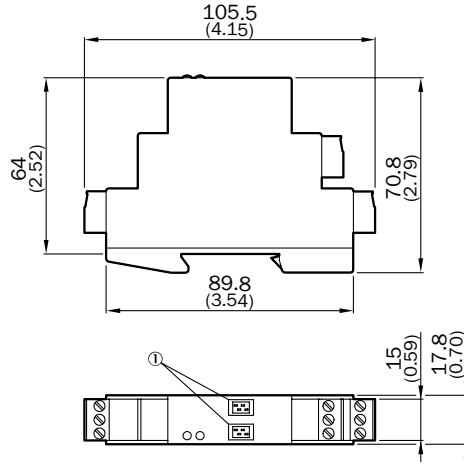



① Only valid for UE12-2FG3

Accessories

Connection systems

Plug connectors and cables

System plugs

Figure	Description	Specialty	Protective coating	Type	Part no.
	System plug: Voltage supply of the Flexi Soft system and storage of system configuration (without EFI-compatible devices)	For FX3-CPU0 and FX3-CPU1	-	FX3-MPL000001	1043700
			✓	FX3-MPL000011	1050619
	System plug: Voltage supply of the Flexi Soft system, storage of system configuration (including EFI-compatible devices), and automatic configuration of connected EFI-compatible safety sensors (automatic configuration recovery)	For FX3-CPU2 and FX3-CPU3	-	FX3-MPL100001	1047162

Connecting cables with male connector



Connection type	Description	Model	Conductor cross-section	Cable length	Type	Part no.
Male connector, M8, 4-pin, angled	For connecting the configuration connection of a PLC	PUR, halogen-free, unshielded	0.25 mm ²	3 m	Connection cable	6036342

Connection cables with female connector and male connector



Figure	Connection type		Model	Conductor cross-section	Cable length	Type	Part no.
	Female connector, D-Sub, 9-pin, straight	Male connector, M8, 4-pin, straight	PVC, unshielded	0.25 mm ²	2 m	DSL-8D04G02M025KM1	6021195
					10 m	DSL-8D04G10M025KM1	2027649

Connection cables with male and male connector

- **Description:** For connecting the configuration connection to the USB interface on the PC



Figure	Connection type		Model	Conductor cross-section	Cable length	Type	Part no.
	Male connector, M8, 4-pin, straight	Male connector, USB-A, straight	PVC, unshielded	0.25 mm ²	2 m	DSL-8U04G02M025KM1	6034574
					10 m	DSL-8U04G10M025KM1	6034575
	Male connector, USB-A, straight	Male connector, Mini-USB, straight	Shielded	-	3 m	Connection cable (male connector-male connector)	6042517
					5 m	Connection cable (male connector-male connector)	6053566

Male connectors (ready to assemble)

Figure	Connection type	Permitted cross-section	Type	Part no.
	Terminal connector, 4-pin, 4 spring terminals	0.25 mm ² ... 1.5 mm ²	Terminal plug spring	2045890
	Terminal connector, 4-pin, 4 screw terminals	≤ 2.5 mm ²	Screw terminal connector	2045891

Cables (ready to assemble)

- **Model:** PVC, shielded
- **Items supplied:** by the meter

Figure	Description	Conductor cross-section	Cable diameter	Number of cores	Type	Part no.
	-	2 x 2 x 0.34 mm ²	Ø 8.5 mm	4-wire	Flexi Link cable	6034249
	Fitting for EFI connections	1 x 2 x 0.22 mm ²	Ø 5.7 mm	2-wire	EFI connecting cable	6029448
		1 x 2 x 1.65 mm ² + 1 x 2 x 0.82 mm ²	Ø 12.2 mm	4-wire	Connection cable	6030756
		2 x 0.34 mm ² + 2 x 0.25 mm ²	Ø 6.9 mm	4-wire	Connection cable	6030921

Adapters and distributors

Other adapters and distributors

Description	Type	Part no.
Diode module, Connects multiple shorting pressure sensitive mats (up to 4)	DM8-A4K	6026142

Power supply units and power supply cables

Figure	Input voltage	Output voltage	Output current	Type	Part no.
 Illustration may differ	100 V AC ... 240 V AC	24 V DC	≤ 2.1 A	PS50WE24V	7028789
			≤ 3.9 A	PS95WE24V	7028790

Further accessories

Muting accessories

- **Description:** LED muting lamp



Figure	Items supplied	Connection type	Cable length	Type	Part no.
 Illustration may differ	Inclusive mounting kit, inclusive connection cable	Cable with M12 male connector	2 m	Indicator lamp	2019909
			10 m	Indicator lamp	2019910

Accessories Motion Control modules

Connection systems

Modules and gateways

Connection modules

Figure	Description	Type	Part no.
	Optimized motor feedback splitter box: facility for connecting two encoders/motor feedback systems. Connection to motion control modules FX3-MOC: female connector, D-Sub HD, 15-pin.	FX3-EBX100002	2079867
	Motor feedback splitter box: facility for connecting an encoder/a motor feedback system. Connection to motion control modules FX3-MOC: female connector, D-Sub HD, 15-pin. Connection for additional motor feedback splitter box: female connector, D-Sub HD, 9-pin.	FX3-EBX300002	2068728
	Dual encoder connection box: facility for connecting two encoders. Connection to motion control modules FX3-MOC: female connector, D-Sub HD, 15-pin.	FX3-EBX400002	2068729

Plug connectors and cables

Connecting cables with male connector

- **Description:** for direct encoder connection
- **Model:** shielded

Figure	Connection type		Cable length	Type	Part no.
	Male connector, Micro D-Sub, 15-pin, straight	Flying leads	2 m	Connecting cable	2067893
	Male connector, Micro D-Sub, 15-pin, angled	Flying leads	1.1 m	Connecting cable	2098351
			2 m	Connecting cable	2077263



Connecting cables with male connector and female connector

- **Description:** for direct encoder connection
- **Model:** shielded

Figure	Connection type		Cable length	Type	Part no.
	Male connector, Micro D-Sub, 15-pin, angled	Female connector, M12, 8-pin, straight	1 m	Connecting cable	2094403
			3 m	Connecting cable	2094426
			5 m	Connecting cable	2094427
			10 m	Connecting cable	2094428

Connection cables with male and male connector

- **Model:** shielded

Figure	Connection type		Description	Cable length	Type	Part no.
	Male connector, D-Sub-HD, 15-pin, straight	Male connector, D-Sub, 9-pin, straight	To connect two motor feedback splitter boxes	0.3 m	Connection cable	2078260
				2 m	Connection cable	2067800
				10 m	Connection cable	2067801
	Male connector, Micro D-Sub, 15-pin, straight	Male connector, D-Sub-HD, 15-pin, straight	To connect motion control modules FX3-MOC with motor feedback splitter box or dual encoder connection box	2 m	Connection cable	2067798
				10 m	Connection cable	2067799
	Male connector, 15-pin, straight	Male connector, D-Sub-HD, 15-pin, angled		2 m	Connection cable	2077261
				10 m	Connection cable	2077262

Connection cables with female connector and female connector

Figure	Connection type		Model	Cable length	Type	Part no.
	Female connector, M12, 8-pin, straight	Female connector, M12, 8-pin, straight	Shielded	0.6 m	Connection cable	2094381

Adapters and distributors

Other adapters and distributors

Connection type		Description	Cable length	Type	Part no.
Male connector and female connector, D-Sub, 15-pin, angled	Male connector, M12, 8-pin, straight	Motor feedback adaptor suitable for a Bosch Rexroth servo amplifier with sin/cos encoder	1.5 m	Adaptor with cable	6034428
	Flying leads		5 m	Adaptor with cable	6067763

COST-SAVING AND SAFE SERIES CONNECTION WITH DIAGNOSTIC FUNCTION

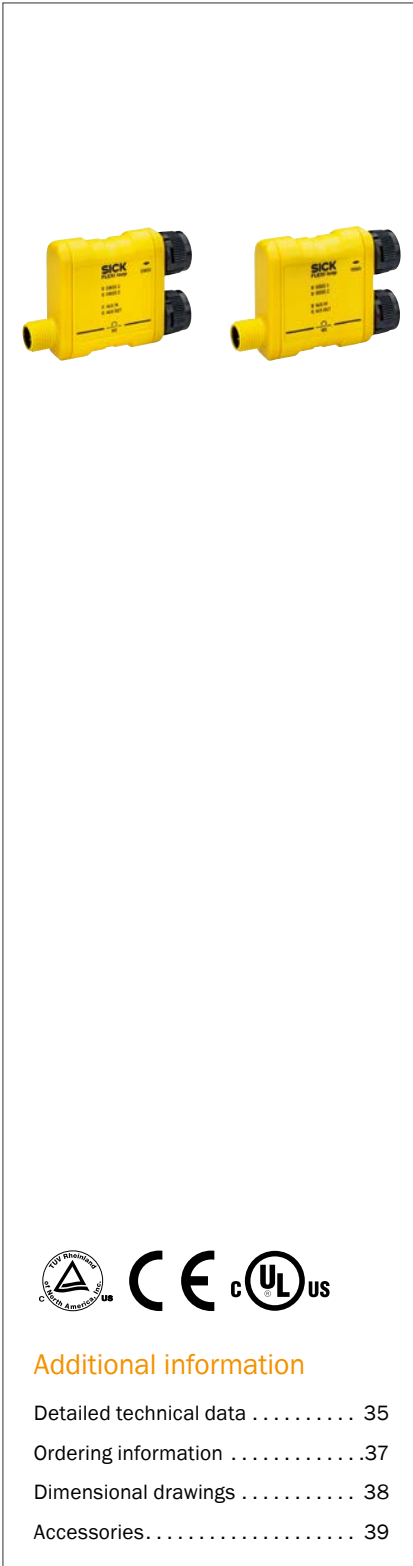

Product description

Flexi Loop can connect up to 32 safety sensors in series in compliance with the highest performance level PL e. Safety switches and safety sensors with OSSD outputs can be used together, regardless of manufacturer. Detailed diagnostic information is also available for each sensor or switch. Integrated switching signals allow for the use of interlocks, switches, and lamps. All sensors are supplied with voltage directly from the Flexi Loop. Unshielded standard cables

are used with M12 male connectors. Ultimately, Flexi Loop can be relied upon for maximum safety. Connecting sensors in series reduces the amount of wiring and the number of safety inputs in the control cabinet. It also provides a comprehensive diagnostic check of all doors, emergency stop pushbuttons, and sensors. In conjunction with Flexi Soft and Flexi Classic, the entire safety application is able to cost-effectively meet customer needs.

At a glance

- Series connection of 32 sensors with up to 100 m per segment in compliance with performance level PL e
- Compatible with sensors from all manufacturers
- Detailed diagnostic information
- Integrated standard inputs and outputs
- Voltage supply for sensors is included
- Unshielded standard cable featuring M12 connectivity
- IP65 and IP67 enclosure rating
- Intelligent accessories for field diagnostics and commissioning

Your benefits

- Connecting both safety switches and safety sensors with OSSD outputs in series minimizes the amount of wiring and the number of inputs at the safety controller, thus reducing costs.
- Easy retrofitting of existing machines
- Simple calculation of the performance level saves time since the Flexi Loop node monitors each sensor individually
- Quick and easy configuration saves time
- Ability to be used over long distances increases application flexibility
- Detailed diagnostic information – who switched and why? minimizes system downtime
- Seamless system integration and communication with other SICK safety controllers
- Detailed status information on Flexi Loop components, diagnostic accessories, and safety controller enable quick and easy field diagnostics

→ www.sick.com/Flexi_Loop

For more information, simply enter the link or scan the QR code and get direct access to technical data, CAD design models, operating instructions, software, application examples, and much more.



Detailed technical data

Safety-related parameters

Safety integrity level	SIL3 (IEC 61508) SILCL3 (EN 62061)
Category	Category 4 (EN ISO 13849)
Performance level	PL e (EN ISO 13849)
PFH_D (mean probability of a dangerous failure per hour)	0.76 x 10 ⁻⁹ (EN ISO 13849)
T_M (mission time)	20 years (EN ISO 13849)

Functions

	OSSD 5-pin	OSSD 8-pin	EMSS 5-pin	EMSS 8-pin
Diagnostic and monitoring functions				
Cross-circuit	Monitoring via OSSD device		Monitoring via Flexi Loop node	
Short-circuit	Monitoring via OSSD device		Monitoring via Flexi Loop node	
Discrepancy errors	Monitoring via Flexi Loop node			
Sequence errors	Monitoring via Flexi Loop node			

Interfaces

	OSSD 5-pin	OSSD 8-pin	EMSS 5-pin	EMSS 8-pin
Connection usage				
Safety device connection	For safety sensor with dual-channel OSSD outputs, With standard input	For safety sensor with dual-channel OSSD outputs, With standard input, with standard output	For dual-channel equivalent electro-mechanical safety switch (EMSS)	For dual-channel equivalent electro-mechanical safety switch (EMSS), With standard input, with standard output
Flexi Loop input	To connect to a Flexi Loop predecessor node or to connect the Flexi Loop line to the Flexi Soft safety controller.			
Flexi Loop output	To connect to a Flexi Loop successor node or to terminate the Flexi Loop line with the Flexi Loop terminator.			
Connection type				
Safety device connection	Female connector M12, 5-pin	Female connector M12, 8-pin	Female connector M12, 5-pin	Female connector M12, 8-pin
Flexi Loop input	Male connector M12, 5-pin			
Flexi Loop output	Female connector M12, 5-pin			
Number of non-safe inputs	1		0	1
Number of non-safe outputs	0	1	0	1
Power supply output for external devices	✓		-	✓

Electrical data

Operating data

	OSSD 5-pin	OSSD 8-pin	EMSS 5-pin	EMSS 8-pin
Protection class	III (EN 61140)			
Type of supply voltage	PELV or SELV			
Supply voltage V_s	24 V DC (16.8 V DC ... 30 V DC)			
Power consumption	45 mA		55 mA	

OSSD inputs

		OSSD 5-pin	OSSD 8-pin	EMSS 5-pin	EMSS 8-pin
Input voltage	HIGH	13 V DC ... 30 V DC		-	
	LOW	-5 V DC ... 5 V DC		-	
Input current	HIGH	3.5 mA ... 6.2 mA		-	
	LOW	-2.5 mA ... 2.5 mA		-	

EMSS interface

		OSSD 5-pin	OSSD 8-pin	EMSS 5-pin	EMSS 8-pin
Test pulse interval		-		40 ms	
Test pulse width		-		12 ms	
Test pulse current via the switch contacts		-		3 mA ... 6.2 mA	

Non-safe inputs

		OSSD 5-pin	OSSD 8-pin	EMSS 5-pin	EMSS 8-pin
Switching voltage	HIGH	13 V DC ... 30 V DC		-	13 V DC ... 30 V DC
	LOW	0 V DC ... 5 V DC		-	0 V DC ... 5 V DC
Input current		≤ 6.2 mA		-	≤ 6.2 mA

Non-safe outputs

		OSSD 5-pin	OSSD 8-pin	EMSS 5-pin	EMSS 8-pin
Type of output		-	Highside driver, short-circuit protected	-	Highside driver, short-circuit protected
Output current		-	≤ 500 mA	-	≤ 500 mA

Power supply output for external devices

		OSSD 5-pin	OSSD 8-pin	EMSS 5-pin	EMSS 8-pin
Supply voltage		24 V DC (16.8 V DC ... 30 V DC)		-	24 V DC (16.8 V DC ... 30 V DC)
Output current		≤ 3.9 A	≤ 2 A	-	≤ 2 A

Mechanical data

Dimensions (W x H x D)	68.15 mm x 48 mm x 18 mm
Weight	28 g (± 5 %)

Ambient data

Enclosure rating	IP65 (EN 60529) IP67 (EN 60529)
Ambient operating temperature	-25 °C ... +55 °C
Storage temperature	-25 °C ... +70 °C

Ordering information

Flexi Loop node for safety sensors with dual-channel OSSD outputs

Connection type	Number of non-safe inputs	Number of non-safe outputs	Type	Part no.
Female connector M12, 5-pin	1	0	FLN-OSSD1000105	1061709
Female connector M12, 8-pin	1	1	FLN-OSSD1100108	1061710

Flexi Loop node for dual-channel equivalent electro-mechanical safety switches

Connection type	Number of non-safe inputs	Number of non-safe outputs	Type	Part no.
Female connector M12, 5-pin	0	0	FLN-EMSS0000105	1061711
Female connector M12, 8-pin	1	1	FLN-EMSS1100108	1061712

Flexi Loop field diagnostics node

Description	Type	Part no.
The diagnostics module is used as a commissioning aid and to display the Flexi Loop states during operation.	FLA-DIAG00001	1061714

Flexi Loop power supply node

Description	Type	Part no.
The power supply module is used to connect a power supply with 24 V DC, for the electrical isolation and for overcurrent shutdown.	FLA-PWRI00001	1061715

Flexi Loop Y-adapter

Description	Type	Part no.
The Flexi Loop Y-adapter (EMMS) splits the 8-pin connection of the FLN-EMSS1100108 in two 5-pin connections: One for dual-channel equivalent electro-mechanical safety switches and one for non-safe I/O signals.	FLA-YCON00001	2074733
The Flexi Loop Y-adapter (OSSD) splits the 8-pin connection of the FLN-OSSD1100108 in two 5-pin connections: One for safety sensors with dual-channel OSSD outputs and one for non-safe I/O signals.	FLA-YCON00002	2074734

Flexi Loop terminator

Description	Type	Part no.
The terminator is used to terminate the safe series connection at the last Flexi Loop node.	FLT-TERM00001	1061716

Dimensional drawings (Dimensions in mm (inch))

OSSD, EMSS

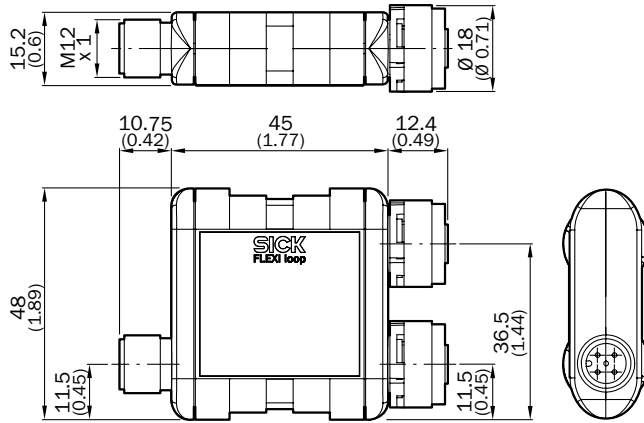

FLA-DIAG

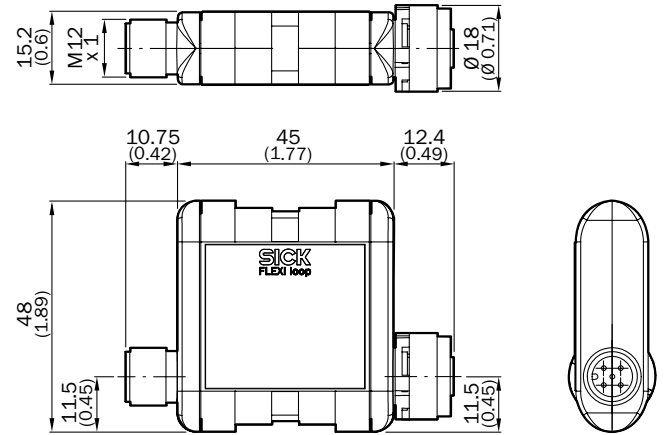

FLA-PWRI00001

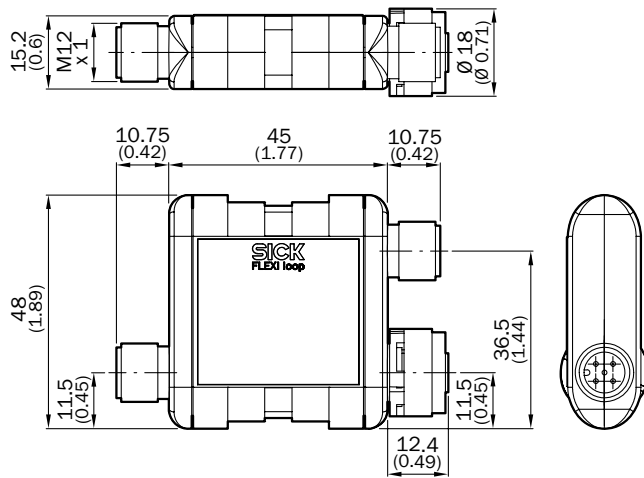

FLA-YCON00001

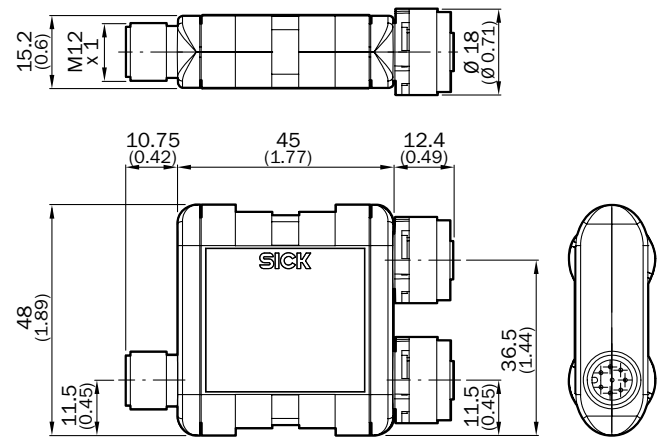

FLT-TERM00001

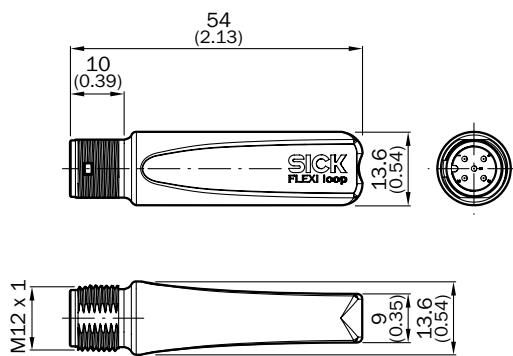

Accessories

Mounting systems

Mounting brackets and plates

Mounting brackets

Figure	Description	Packing unit	Type	Part no.
	Flexi Loop fixing clip	1 piece	C-Fix bracket	2068830

Dimensional drawings → [page 41](#)

Connection systems

Plug connectors and cables



Connecting cables with female connector

- **Model:** PUR, halogen-free, unshielded

Figure	Connection type		Conductor cross-section	Cable length	Type	Part no.
	Female connector, M12, 5-pin, straight	Open cable ends	0.34 mm ²	5 m	YF2A15-050UB5XLEAX	2095618
				10 m	YF2A15-100UB5XLEAX	2095619
				15 m	YF2A15-150UB5XLEAX	2095620
				20 m	YF2A15-200UB5XLEAX	2095614
				30 m	YF2A15-300UB5XLEAX	2095621



Connecting cables with male connector

- **Model:** PUR, halogen-free, unshielded

Figure	Connection type		Conductor cross-section	Cable length	Type	Part no.
	Male connector, M12, 5-pin, straight	Open cable ends	0.34 mm ²	1 m	YM2A15-010UB5XLEAX	2095104
				2 m	YM2A15-020UB5XLEAX	2095840
				5 m	YM2A15-050UB5XLEAX	2095842
				10 m	YM2A15-100UB5XLEAX	2095843
	Male connector, M12, 8-pin, straight	Open cable ends	0.25 mm ²	1 m	YM2A18-010UA5XLEAX	2095871
				2 m	YM2A18-020UA5XLEAX	2095868
				5 m	YM2A18-050UA5XLEAX	2095869
				10 m	YM2A18-100UA5XLEAX	2095870

Connection cables with female connector and male connector

- **Model:** PUR, halogen-free, unshielded

Figure	Connection type		Conductor cross-section	Cable length	Type	Part no.
	Female connector, M12, 5-pin, straight	Male connector, M12, 5-pin, straight	0,34 mm ²	0,15 m	YF2A15-C15UB5M2A15	2096004
				0,6 m	YF2A15-C60UB5M2A15	2096006
				1 m	YF2A15-010UB5M2A15	2096007
				1,5 m	YF2A15-015UB5M2A15	2096008
				2 m	YF2A15-020UB5M2A15	2096009
				5 m	YF2A15-050UB5M2A15	2096010
				10 m	YF2A15-100UB5M2A15	2096011
				15 m	YF2A15-150UB5M2A15	2096171
				20 m	YF2A15-200UB5M2A15	2095844
				30 m	YF2A15-300UB5M2A15	2095845
	Female connector, M12, 8-pin, straight	Male connector, M12, 8-pin, straight	0,25 mm ²	0,6 m	YF2A18-C60UA5M2A18	2096031
				1 m	YF2A18-010UA5M2A18	2096032
				1,5 m	YF2A18-015UA5M2A18	2096012
				2 m	YF2A18-020UA5M2A18	2096033
				5 m	YF2A18-050UA5M2A18	2096034
				10 m	YF2A18-100UA5M2A18	2096035

Female connectors (ready to assemble)

Figure	Connection type	Permitted cross-section	Permitted cable diameter	Type	Part no.
	Female connector, M12, 5-pin, straight, screw-type terminals	≤ 0.75 mm ²	4 mm ... 6 mm	DOS-1205-G	6009719
	Female connector, M12, 8-pin, straight, screw-type terminals	0.25 mm ² ... 0.5 mm ²	6 mm ... 8 mm	DOS-1208-G	6028422
	Female connector, M12, 8-pin, angled, screw-type terminals	0.25 mm ² ... 0.5 mm ²	6 mm ... 8 mm	DOS-1208-W	2092035

Male connectors (ready to assemble)

Figure	Connection type	Permitted cross-section	Permitted cable diameter	Type	Part no.
	Male connector, M12, 5-pin, straight, screw-type terminals	≤ 0.75 mm ²	4 mm ... 6 mm	STE-1205-G	6022083
	Male connector, M12, 8-pin, straight, screw-type terminals	0.25 mm ² ... 0.5 mm ²	6 mm ... 8 mm	STE-1208-G	6033269

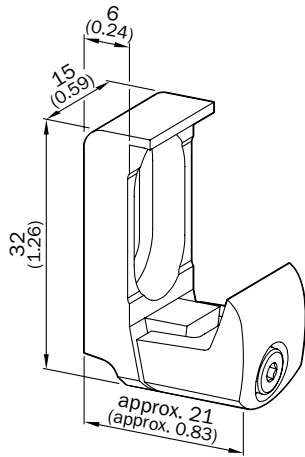
Dimensional drawings for accessories (Dimensions in mm (inch))**Mounting brackets and plates****C-Fix bracket**

REGISTER AT WWW.SICK.COM TO TAKE ADVANTAGE OF OUR FOLLOWING SERVICES FOR YOU





- ✓ Access information on net prices and individual discounts.
- ✓ Easily order online and track your delivery.
- ✓ Check your history of all your orders and quotes.
- ✓ Create, save, and share as many wish lists as you want.
- ✓ Use the direct order to quickly order a big amount of products.
- ✓ Check the status of your orders and quotes and get information on status changes by e-mail.
- ✓ Save time by using past orders.
- ✓ Easily export orders and quotes, suited to your systems.



SERVICES FOR MACHINES AND PLANTS: SICK LifeTime Services

Our comprehensive and versatile LifeTime Services are the perfect addition to the comprehensive range of products from SICK. The services range from product-independent consulting to traditional product services.



- 
Consulting and design
 Safe and professional
- 
Product and system support
 Reliable, fast, and on-site
- 
Verification and optimization
 Safe and regularly inspected
- 
Upgrade and retrofits
 Easy, safe, and economical
- 
Training and education
 Practical, focused, and professional

SICK AT A GLANCE

SICK is a leading manufacturer of intelligent sensors and sensor solutions for industrial applications. With more than 9,700 employees and over 50 subsidiaries and equity investments as well as numerous agencies worldwide, we are always close to our customers. A unique range of products and services creates the perfect basis for controlling processes securely and efficiently, protecting individuals from accidents and preventing damage to the environment.

We have extensive experience in various industries and understand their processes and requirements. With intelligent sensors, we can deliver exactly what our customers need. In application centers in Europe, Asia and North America, system solutions are tested and optimized in accordance with customer specifications. All this makes us a reliable supplier and development partner.

Comprehensive services round out our offering: SICK LifeTime Services provide support throughout the machine life cycle and ensure safety and productivity.

For us, that is “Sensor Intelligence.”

Worldwide presence:

Australia, Austria, Belgium, Brazil, Canada, Chile, China, Czech Republic, Denmark, Finland, France, Germany, Great Britain, Hungary, Hong Kong, India, Israel, Italy, Japan, Malaysia, Mexico, Netherlands, New Zealand, Norway, Poland, Romania, Russia, Singapore, Slovakia, Slovenia, South Africa, South Korea, Spain, Sweden, Switzerland, Taiwan, Thailand, Turkey, United Arab Emirates, USA, Vietnam.

Detailed addresses and further locations → www.sick.com