

nanoScan3 I/O

Safety laser scanners

SICK
Sensor Intelligence.



Product described

nanoScan3 I/O

Manufacturer

SICK AG
Erwin-Sick-Str. 1
79183 Waldkirch
Germany

Legal information

This work is protected by copyright. Any rights derived from the copyright shall be reserved for SICK AG. Reproduction of this document or parts of this document is only permissible within the limits of the legal determination of Copyright Law. Any modification, abridgment or translation of this document is prohibited without the express written permission of SICK AG.

The trademarks stated in this document are the property of their respective owner.

© SICK AG. All rights reserved.

Original document

This document is an original document of SICK AG.



Contents

| | | |
|----------|--|-----------|
| 1 | About this document..... | 8 |
| 1.1 | Scope..... | 8 |
| 1.2 | Target groups of these operating instructions..... | 8 |
| 1.3 | Further information..... | 8 |
| 1.4 | Symbols and document conventions..... | 8 |
| 2 | Safety information..... | 10 |
| 2.1 | General safety notes..... | 10 |
| 2.2 | Intended use..... | 11 |
| 2.3 | Inappropriate use..... | 11 |
| 2.4 | Cybersecurity..... | 11 |
| 2.5 | Requirements for the qualification of personnel..... | 12 |
| 3 | Product description..... | 13 |
| 3.1 | Product identification via the SICK product ID..... | 13 |
| 3.2 | Device overview..... | 13 |
| 3.3 | Structure and function..... | 14 |
| 3.4 | Product characteristics..... | 15 |
| 3.4.1 | Variants..... | 15 |
| 3.4.2 | System plug..... | 16 |
| 3.4.3 | Field types..... | 16 |
| 3.5 | Example applications..... | 17 |
| 4 | Project planning..... | 20 |
| 4.1 | Manufacturer of the machine..... | 20 |
| 4.2 | Operating entity of the machine..... | 20 |
| 4.3 | Design..... | 20 |
| 4.3.1 | Protection from interference..... | 21 |
| 4.3.2 | Preventing unprotected areas..... | 22 |
| 4.3.3 | Reference contour monitoring..... | 23 |
| 4.3.4 | Monitoring case switching time..... | 25 |
| 4.3.5 | Minimum distance for stationary applications..... | 26 |
| 4.3.6 | Supplement Z_R for reflection-based measurement errors.... | 27 |
| 4.3.7 | Hazardous area protection..... | 27 |
| 4.3.8 | Hazardous point protection..... | 31 |
| 4.3.9 | Access protection..... | 33 |
| 4.3.10 | Mobile hazardous area protection..... | 35 |
| 4.4 | Integration in the electrical control system..... | 40 |
| 4.4.1 | Electromagnetic compatibility..... | 40 |
| 4.4.2 | Voltage supply..... | 41 |
| 4.4.3 | USB connection..... | 41 |
| 4.4.4 | OSSDs..... | 41 |
| 4.4.5 | Control inputs..... | 42 |
| 4.4.6 | Universal inputs, universal outputs, universal I/Os..... | 45 |

| | | |
|----------|---|-----------|
| 4.4.7 | Restart interlock..... | 45 |
| 4.4.8 | External device monitoring (EDM)..... | 47 |
| 4.5 | Integration into the network..... | 48 |
| 4.5.1 | Network services and ports..... | 48 |
| 4.6 | Testing plan..... | 48 |
| 4.6.1 | Planning the thorough check during commissioning and in certain situations..... | 49 |
| 4.6.2 | Planning the regular thorough check..... | 49 |
| 4.6.3 | Notes on the tests..... | 50 |
| 5 | Mounting..... | 53 |
| 5.1 | Safety..... | 53 |
| 5.2 | Unpacking..... | 53 |
| 5.3 | Fitting the system plug..... | 53 |
| 5.4 | Mounting the device..... | 54 |
| 6 | Electrical installation..... | 55 |
| 6.1 | Safety..... | 55 |
| 6.2 | Connecting..... | 55 |
| 6.2.1 | Connecting cable with M12 plug connector, 8-pin..... | 55 |
| 6.2.2 | Connecting cable with M12 plug connector, 17-pin..... | 56 |
| 6.2.3 | Connecting cable with flying leads, 17-wire..... | 58 |
| 6.2.4 | Network connection..... | 59 |
| 7 | Configuration..... | 60 |
| 7.1 | Delivery state..... | 60 |
| 7.2 | Safety Designer configuration software..... | 60 |
| 7.2.1 | Installing Safety Designer..... | 60 |
| 7.2.2 | Projects..... | 60 |
| 7.2.3 | User interface..... | 62 |
| 7.2.4 | User groups..... | 62 |
| 7.2.5 | Settings..... | 64 |
| 7.2.6 | Configuration..... | 64 |
| 7.3 | Overview..... | 66 |
| 7.4 | Network settings..... | 68 |
| 7.4.1 | Ethernet..... | 68 |
| 7.5 | Time synchronization..... | 68 |
| 7.6 | Reading configuration..... | 68 |
| 7.7 | Identification..... | 69 |
| 7.8 | Application..... | 69 |
| 7.9 | Monitoring plane..... | 70 |
| 7.10 | Contour as Reference field..... | 72 |
| 7.11 | Fields..... | 74 |
| 7.11.1 | Creating field set templates..... | 76 |
| 7.11.2 | Importing and exporting field sets and fields..... | 77 |
| 7.11.3 | Background image..... | 77 |

| | | |
|-----------|---|------------|
| 7.11.4 | Settings for the field editor..... | 78 |
| 7.11.5 | Editing fields using coordinates..... | 78 |
| 7.11.6 | Drawing in points that cannot be monitored..... | 80 |
| 7.11.7 | Defining global geometry..... | 80 |
| 7.11.8 | Enable propose field..... | 81 |
| 7.12 | Inputs and outputs, local..... | 82 |
| 7.12.1 | Outputs..... | 83 |
| 7.12.2 | Inputs..... | 83 |
| 7.12.3 | Further settings for some signals..... | 84 |
| 7.13 | Monitoring cases..... | 86 |
| 7.13.1 | Settings for monitoring case tables..... | 86 |
| 7.13.2 | Several monitoring case tables..... | 88 |
| 7.13.3 | Settings for monitoring cases..... | 88 |
| 7.13.4 | Input condition..... | 88 |
| 7.13.5 | Cut-off paths..... | 89 |
| 7.13.6 | Assigning field sets..... | 89 |
| 7.13.7 | Assigning a defined cut-off behavior..... | 89 |
| 7.14 | Simulation..... | 90 |
| 7.15 | Data output..... | 91 |
| 7.16 | Transferring a configuration..... | 92 |
| 7.16.1 | Verify configuration..... | 93 |
| 7.17 | Starting and stopping safety function..... | 93 |
| 7.18 | Report..... | 94 |
| 7.19 | Service..... | 95 |
| 7.19.1 | Restart device..... | 95 |
| 7.19.2 | Factory settings..... | 95 |
| 7.19.3 | Managing passwords..... | 96 |
| 7.19.4 | Access management..... | 96 |
| 7.19.5 | Optics cover calibration..... | 97 |
| 7.19.6 | Compare configuration..... | 98 |
| 8 | Commissioning..... | 99 |
| 8.1 | Safety..... | 99 |
| 8.2 | Overview..... | 99 |
| 8.3 | Alignment..... | 99 |
| 8.4 | Switching on..... | 99 |
| 8.5 | Check during commissioning and modifications..... | 100 |
| 9 | Operation..... | 101 |
| 9.1 | Safety..... | 101 |
| 9.2 | Regular thorough check..... | 101 |
| 9.3 | Status indicators..... | 101 |
| 9.4 | Status indicator with the display..... | 102 |
| 10 | Maintenance..... | 106 |
| 10.1 | Safety..... | 106 |

| | | |
|-----------|---|------------|
| 10.2 | Regular cleaning..... | 106 |
| 10.3 | Replacing the optics cover..... | 107 |
| 10.4 | Replacing the safety laser scanner..... | 109 |
| 10.4.1 | Replacing the safety laser scanner without system plug..... | 109 |
| 10.4.2 | Replacing the safety laser scanner with system plug..... | 110 |
| 10.5 | Replacing the system plug..... | 110 |
| 10.6 | Regular thorough check..... | 111 |
| 11 | Troubleshooting..... | 112 |
| 11.1 | Safety..... | 112 |
| 11.2 | Detailed diagnostics using the display..... | 112 |
| 11.3 | Error indication on the display..... | 113 |
| 11.4 | Diagnostics using Safety Designer..... | 115 |
| 11.4.1 | Data recorder..... | 116 |
| 11.4.2 | Event history..... | 117 |
| 11.4.3 | Message history..... | 119 |
| 12 | Decommissioning..... | 120 |
| 12.1 | Disposal..... | 120 |
| 13 | Technical data..... | 121 |
| 13.1 | Version numbers and functional scope..... | 121 |
| 13.2 | Data sheet..... | 122 |
| 13.3 | Response times..... | 127 |
| 13.4 | Course of the OSSD test over time..... | 127 |
| 13.5 | Sensing range..... | 128 |
| 13.6 | Dimensional drawings..... | 131 |
| 14 | Ordering information..... | 132 |
| 14.1 | Scope of delivery..... | 132 |
| 14.2 | Ordering information..... | 132 |
| 15 | Spare parts..... | 133 |
| 15.1 | Additional spare parts..... | 133 |
| 16 | Accessories..... | 134 |
| 16.1 | System plug..... | 134 |
| 16.2 | Additional accessories..... | 135 |
| 17 | Glossary..... | 136 |
| 18 | Annex..... | 140 |
| 18.1 | Conformities and certificates..... | 140 |
| 18.1.1 | EU declaration of conformity..... | 140 |
| 18.1.2 | UK declaration of conformity..... | 140 |
| 18.2 | Note on standards..... | 140 |
| 18.3 | Licenses..... | 142 |

18.4 Checklist for initial commissioning and commissioning..... 143

19 List of figures..... 144

20 List of tables..... 146

1 About this document

1.1 Scope

Product

This document applies to the following products:

- Product code: nanoScan3 I/O
- "Operating instructions" type label entry: 8024594

Document identification

Document part number:

- This document: 8024596
- Available language versions of this document: 8024594

You can find the current version of all documents at www.sick.com.

1.2 Target groups of these operating instructions

Some sections of these operating instructions are intended for certain target groups. However, the entire operating instructions are relevant for intended use of the product.

Table 1: Target groups and selected sections of these operating instructions

| Target group | Sections of these operating instructions |
|--|--|
| Project developers (planners, developers, designers) | "Project planning", page 20 "Configuration", page 60 "Technical data", page 121 "Accessories", page 134 |
| Installers | "Mounting", page 53 |
| Electricians | "Electrical installation", page 55 |
| Safety experts (such as CE authorized representatives, compliance officers, people who test and approve the application) | "Project planning", page 20 "Configuration", page 60 "Commissioning", page 99 "Technical data", page 121 "Checklist for initial commissioning and commissioning", page 143 |
| Operators | "Operation", page 101 "Troubleshooting", page 112 |
| Maintenance personnel | "Maintenance", page 106 "Troubleshooting", page 112 |

1.3 Further information

www.sick.com

The following information is available via the Internet:

- Data sheets and application examples
- CAD files and dimensional drawings
- Certificates (such as the EU declaration of conformity)
- Guide for Safe Machinery. Six steps to a safe machine
- Safety Designer (software for configuring safety solutions made by SICK AG)

1.4 Symbols and document conventions

The following symbols and conventions are used in this document:

Warnings and other notes



DANGER

Indicates a situation presenting imminent danger, which will lead to death or serious injuries if not prevented.



WARNING

Indicates a situation presenting possible danger, which may lead to death or serious injuries if not prevented.



CAUTION

Indicates a situation presenting possible danger, which may lead to moderate or minor injuries if not prevented.



NOTICE

Indicates a situation presenting possible danger, which may lead to property damage if not prevented.



NOTE

Highlights useful tips and recommendations as well as information for efficient and trouble-free operation.

Instructions to action

- ▶ The arrow denotes instructions to action.
- 1. The sequence of instructions for action is numbered.
- 2. Follow the order in which the numbered instructions are given.
- ✓ The check mark denotes the result of an instruction.

LED symbols

These symbols indicate the status of an LED:

- The LED is off.
- ◐ The LED is flashing.
- The LED is illuminated continuously.

2 Safety information

2.1 General safety notes

Integrating the product



DANGER

The product can not offer the expected protection if it is integrated incorrectly.

- ▶ Plan the integration of the product in accordance with the machine requirements (project planning).
 - ▶ Implement the integration of the product in accordance with the project planning.
-

Laser class 1



CAUTION

Optical radiation: Class 1 Laser Product

Caution - if any operating or calibrating equipment other than those specified here are used or other methods are employed, this can lead to dangerous exposure to radiation.

- ▶ Use only the tools and auxiliary equipment specified in this documentation.
 - ▶ Only carry out the procedures specified in this documentation.
 - ▶ Do not open the housing unless carrying out the mounting and maintenance operations provided in this documentation.
-



Figure 1: Laser class 1

This device complies with the following standards:

- IEC 60825-1:2014
- 21 CFR 1040.10 and 1040.11, except compliance with IEC 60825-1:2014, as described in Laser Notice No. 56 dated 08.05.2019

The laser is eye-safe.

The laser marking is located on the underside of the safety laser scanner.

Mounting and electrical installation



DANGER

Death or severe injury due to electrical voltage and/or an unexpected startup of the machine

- ▶ Make sure that the machine is (and remains) disconnected from the voltage supply during mounting and electrical installation.
 - ▶ Make sure that the dangerous state of the machine is and remains switched off.
-

Repairs and modifications



DANGER

Improper work on the product

A modified product may not offer the expected protection if it is integrated incorrectly.

- ▶ Apart from the procedures described in this document, do not repair, open, manipulate or otherwise modify the product.

2.2 Intended use

The safety laser scanner is an electro-sensitive protective device (ESPE) and is suitable for the following applications:

- Hazardous area protection
- Hazardous point protection
- Access protection
- Mobile hazardous area protection (protection of automated guided vehicles)

The product may be used in safety functions.

The safety laser scanner must only be used within the limits of the prescribed and specified technical data and operating conditions at all times.

Incorrect use, improper modification or manipulation of the safety laser scanner will invalidate any warranty from SICK; in addition, any responsibility and liability of SICK for damage and secondary damage caused by this is excluded.

2.3 Inappropriate use

The safety laser scanner works as an indirect protective measure and cannot provide protection from pieces thrown from the application nor from emitted radiation. Transparent objects are not detected.

The safety laser scanner is not suitable for the following applications, among others:

- Outdoors
- Underwater
- In explosion-hazardous areas

2.4 Cybersecurity

Overview

To protect against cybersecurity threats, it is necessary to continuously monitor and maintain a comprehensive cybersecurity concept. A suitable concept consists of organizational, technical, procedural, electronic, and physical levels of defense and considers suitable measures for different types of risks. The measures implemented in this product can only support protection against cybersecurity threats if the product is used as part of such a concept.

You will find further information at www.sick.com/psirt, e.g.:

- General information on cybersecurity
- Contact option for reporting vulnerabilities
- Information on known vulnerabilities (security advisories)

Communication interfaces

- USB
- Ethernet for data output, configuration and diagnostics ¹⁾
- Display and pushbuttons

¹⁾ The network connection is available for certain system plugs.

Further topics

- ["Network services and ports", page 48](#)
- ["Managing passwords", page 96](#)
- ["Access management", page 96](#)

2.5 Requirements for the qualification of personnel

The product must be configured, installed, connected, commissioned, and serviced by qualified safety personnel only.

Project planning

You need safety expertise to implement safety functions and select suitable products for that purpose. You need expert knowledge of the applicable standards and regulations.

Mounting, electrical installation and commissioning

You need suitable expertise and experience. You must be able to assess if the machine is operating safely.

Configuration

You need suitable expertise and experience. You must be able to assess if the machine is operating safely.

Operation and maintenance

You need suitable expertise and experience. You must be instructed in machine operation by the machine operator. For maintenance, you must be able to assess if the machine is operating safely.

3 Product description

3.1 Product identification via the SICK product ID

SICK product ID

The SICK product ID uniquely identifies the product. It also serves as the address of the web page with information on the product.

The SICK product ID comprises the host name pid.sick.com, the part number (P/N), and the serial number (S/N), each separated by a forward slash.

For newer products, the SICK product ID is displayed as text and QR code on the type label and/or on the packaging.



Figure 2: SICK product ID

3.2 Device overview

Overview

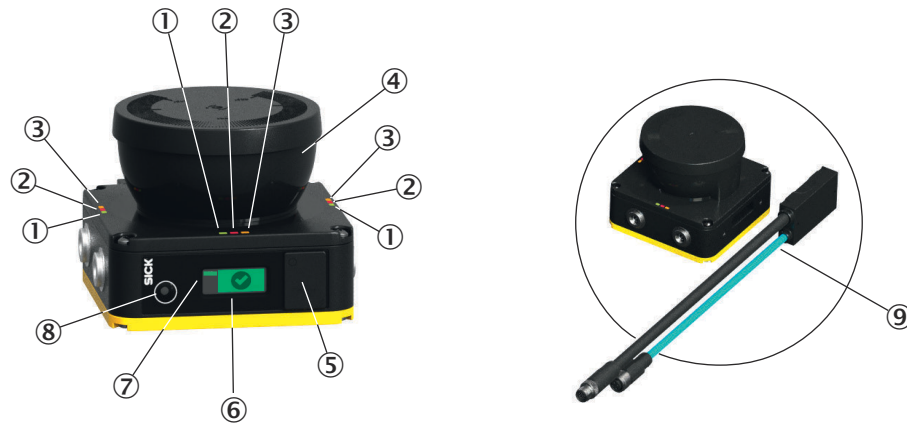

Figure 3: Device overview

- ① LED ON status
- ② LED OFF status
- ③ LED restart interlock/warning field
- ④ Optics cover
- ⑤ USB connection
- ⑥ Display
- ⑦ Network LED
- ⑧ Pushbutton
- ⑨ System plug

Complementary information

Position and direction information in this document:

- The top is the side of the device on which the optics cover is located.
- The bottom is the side of the device opposite the optics cover.

- The front is the side of the device on which the display is located. The 90° angle of the sector of a circle scanned by the device points in this direction.
- The back is the side of the device opposite the display. The sector of a circle not scanned by the device lies in this direction.

Further topics

- ["Connecting", page 55](#)
- ["Status indicators", page 101](#)

3.3 Structure and function

The safety laser scanner is an electro-sensitive protective device (ESPE) which scans its surroundings two-dimensionally using infrared laser beams.

The safety laser scanner forms a protective field using the invisible laser beams. This protective field protects the hazardous area and enables hazardous point protection, access protection or hazardous area protection. As soon as an object is situated in the protective field, the safety laser scanner signals the detection by means of a signal change at the safety output. The machine or its control must safely analyze the signals (for example using a safe control or safety relays) and stop the dangerous state.

The safety laser scanner operates on the principle of optical time-of-flight measurement. It emits light pulses in regular, very short intervals. If the light strikes an object, it is reflected. The safety laser scanner receives the reflected light. The safety laser scanner calculates the distance to the object based on the time interval between the moment of transmission and moment of receipt (Δt).

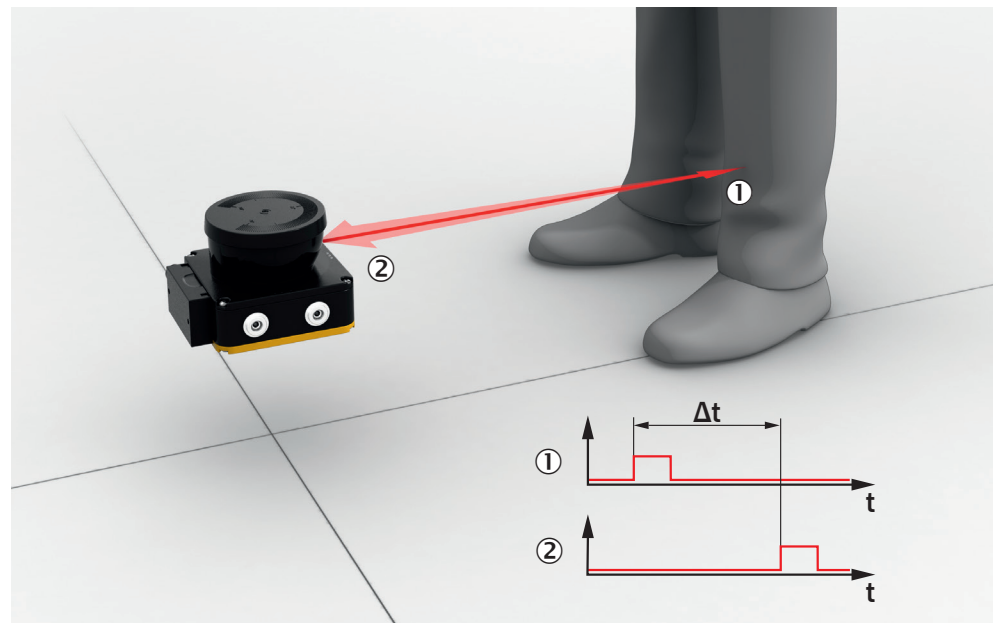

Figure 4: Principle of time-of-flight measurement

- ① Transmitted light pulse
- ② Reflected light pulse

A rotating mirror is situated in the safety laser scanner. The mirror deflects the light pulses so that they scan a fan-shaped area.

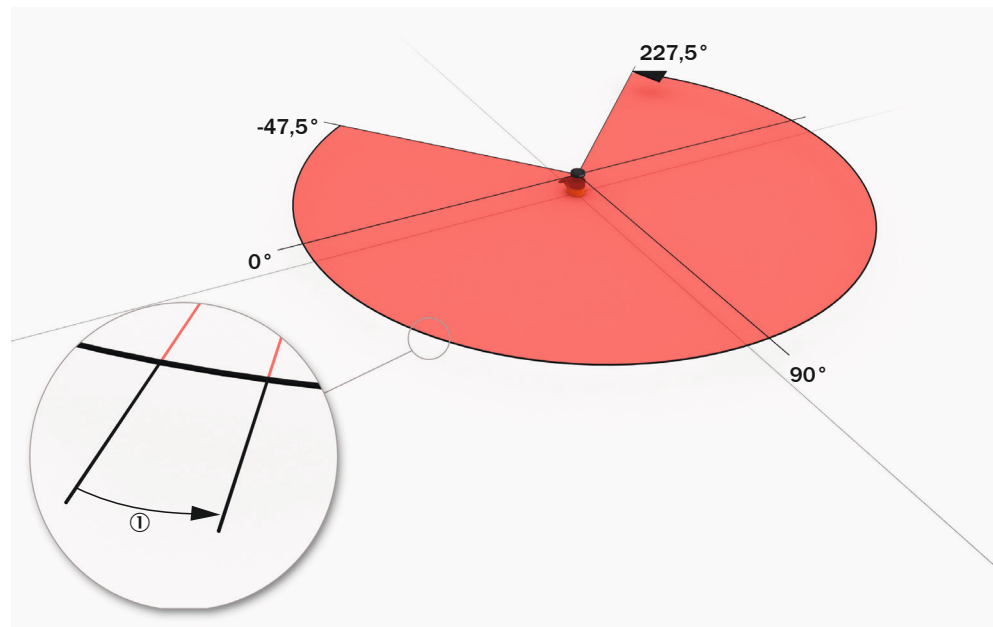

Figure 5: Light pulses scan an area

- ① Angular resolution: the angular distance (in degrees) between 2 distance measurements

Scan cycle time and resolution

The time that the mirror requires for one rotation is called the scan cycle time. The number of light pulses per unit of time is constant. The scan cycle time and the number of light pulses per unit of time determine the angular resolution. The scanning range for a given object resolution depends on the angular resolution. The object resolution indicates the minimum size that an object must be to allow it to be detected safely. The scan cycle time also influences the response time.

The resolution in protective fields can be set to various values according to the intended purpose.

Geometry of the scan plane

The laser beams emitted cover a sector of a circle, so an object can be detected in an area of up to 275°.

The sector of a circle covered ranges from -47.5° to 227.5° , where 90° denotes the axis of the safety laser scanner from the back to the front. When viewing the safety laser scanner from above, the direction of rotation of the mirror and the deflected light pulses is counterclockwise, [see figure 5, page 15](#).

3.4 Product characteristics

3.4.1 Variants

The device is available in various variants. You will find an overview of important distinguishing features of the variants in the following.

Performance package

The Core and Pro performance packages feature a number of configurable fields and a number of safety switching functions.

- nanoScan3 core I/O: 8 fields, 1 OSSD pair
- nanoScan3 Pro I/O: 128 fields, 2 OSSD pairs

Integration in the control

The device communicates with the machine controller as follows:

- I/O: local inputs and outputs (incl. OSSDs)

Connection type

Some variants are available with different connection types:

- Connecting cable with M12 round connector
- Connecting cable with flying leads

Ethernet connection for configuration and data output

The device is available with or without Ethernet connection for configuration, diagnostics and data output.

Further topics

- ["Ordering information", page 132](#)

3.4.2 System plug

The safety laser scanner requires a system plug.

The safety laser scanner's configuration memory is integrated in the system plug. The system plug and all connecting cables can remain at the installation site when the safety laser scanner is replaced. The system plug is detached from the defective safety laser scanner and connected to the new safety laser scanner. The new safety laser scanner reads the configuration from the configuration memory when switched on.

3.4.3 Field types

During operation, the safety laser scanner uses its laser beams to continuously check whether people or objects are present in one or more areas. The areas to be checked are called fields. A distinction is made between the following field types, depending on the application type:

- Protective field
- Contour as Reference field
- Contour detection field
- Warning field

Table 2: Field types and their function

| | Protective field | Contour as Reference field | Contour detection field | Warning field |
|--|------------------------------------|----------------------------|-------------------------|---|
| Safe switch off (according to ISO 13849-1) | Yes (PL d) | Yes (PL d) | Yes (PL d) | No |
| Maximum scanning range of the safety laser scanner | 3.0 m | 3.0 m | 3.0 m | 10 m |
| Purpose | Detection and protection of people | Tamper protection | Contour monitoring | Functional use (not safety application) |

| | Protective field | Contour as Reference field | Contour detection field | Warning field |
|-------------|--|--|---|--|
| Description | The protective field is the area in which the test object specified by the manufacturer is detected by the electro-sensitive protective equipment (ESPE). As soon as the electro-sensitive protective device detects an object in the protective field, it switches the associated safety outputs to the OFF state. This signal can be passed to controllers resulting in the dangerous state coming to an end, e.g. to stop the machine or the vehicle. | The contour as reference field monitors a contour of the environment. The safety laser scanner switches all safety outputs to the OFF state if a contour does not match the set parameters, because, for example, the mounting of the safety laser scanner has been changed. | The contour detection field monitors a contour of the environment. The electro-sensitive protective device switches the associated safety outputs to the OFF state if a contour does not correspond to the set specifications, e.g. because a door or flap is open. | The warning field monitors larger areas than the protective field. Simple switching functions can be triggered with the warning field, e.g. a warning light or an acoustic signal can be triggered if a person approaches, even before the person enters the protective field. |

3.5 Example applications

Hazardous area protection

In hazardous area protection, people are detected if they stay in a defined area.

This type of protective device is suitable for machines, where it is possible to see a hazardous area completely from the reset pushbutton. When the hazardous area is entered, a stop signal is triggered and starting is prevented.

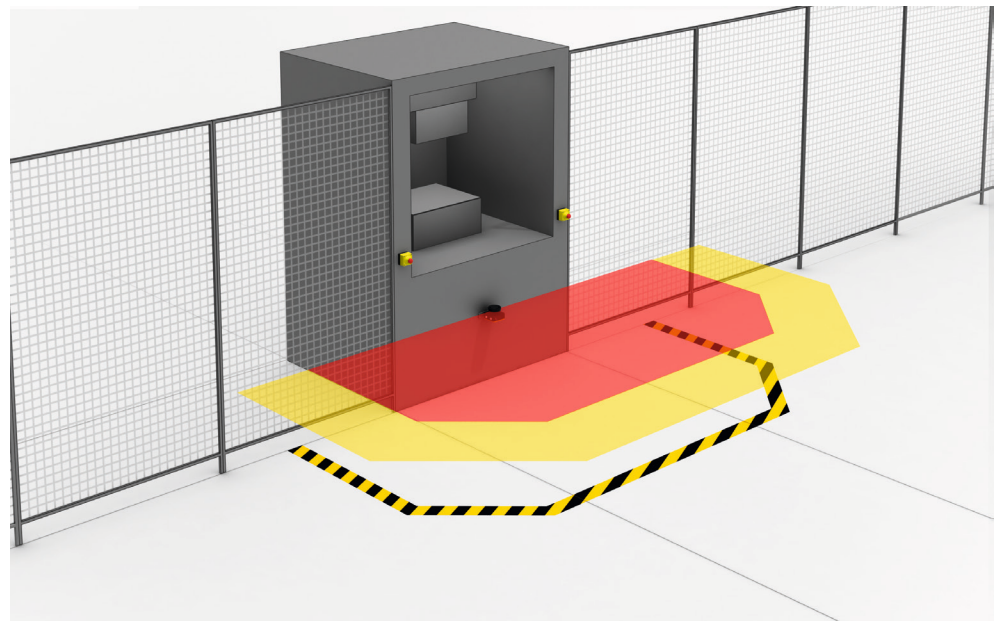

Figure 6: Hazardous area protection: detection of the presence of a person in the hazardous area

Hazardous point protection

In hazardous point protection, the approach is detected very close to the hazardous point.

The advantage of this type of protective device is that it is possible to have a short minimum distance and the operator can work more ergonomically.

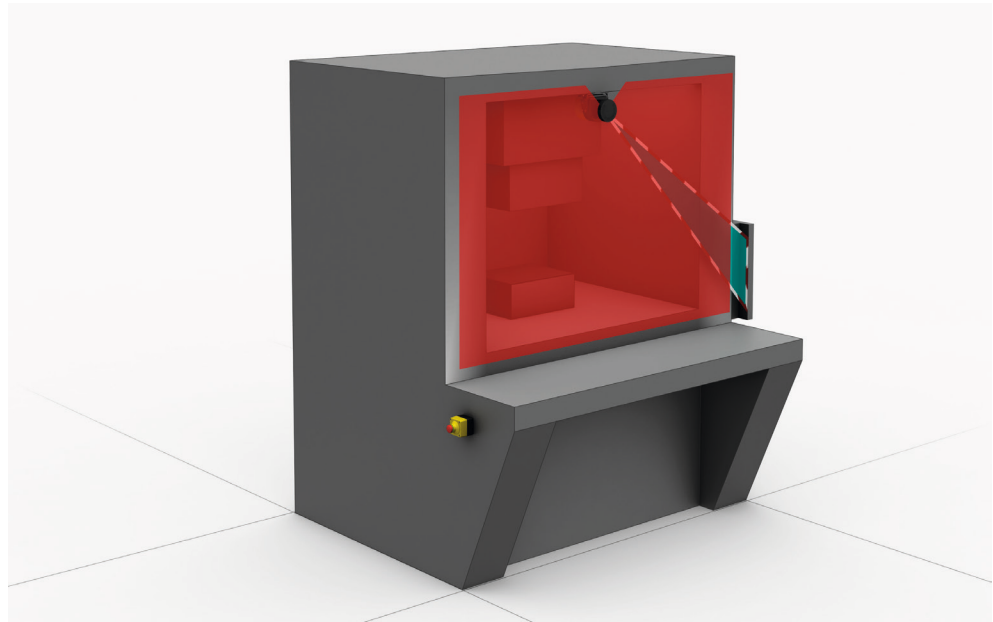

Figure 7: Hazardous point protection: Hand detection

Access protection

In access protection, people are detected if their whole body passes through the protective field.

This type of protective device is used for the protection of access to hazardous areas. A stop signal is initiated if the hazardous area is entered. A person standing behind the protective device will not be detected by the ESPE.

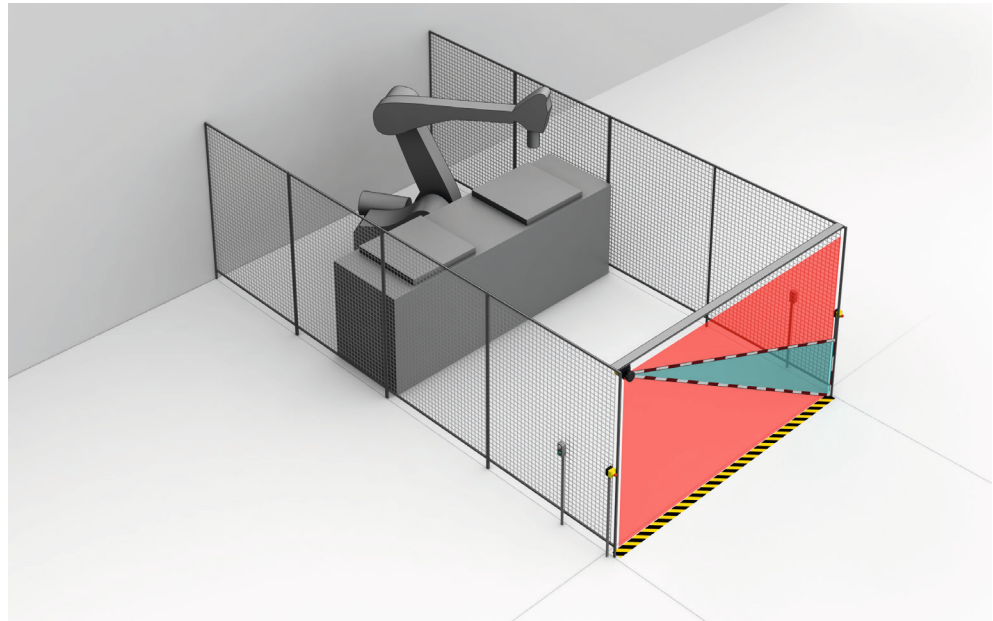

Figure 8: Access protection: detection of a person when accessing a hazardous area

Mobile hazardous area protection

Mobile hazardous area protection is suitable for AGVs (automated guided vehicles) and forklift trucks to protect people when vehicles are moving or docking at a fixed station.

The safety laser scanner monitors the area in the direction of travel and stops the vehicle as soon as an object is located in the protective field.

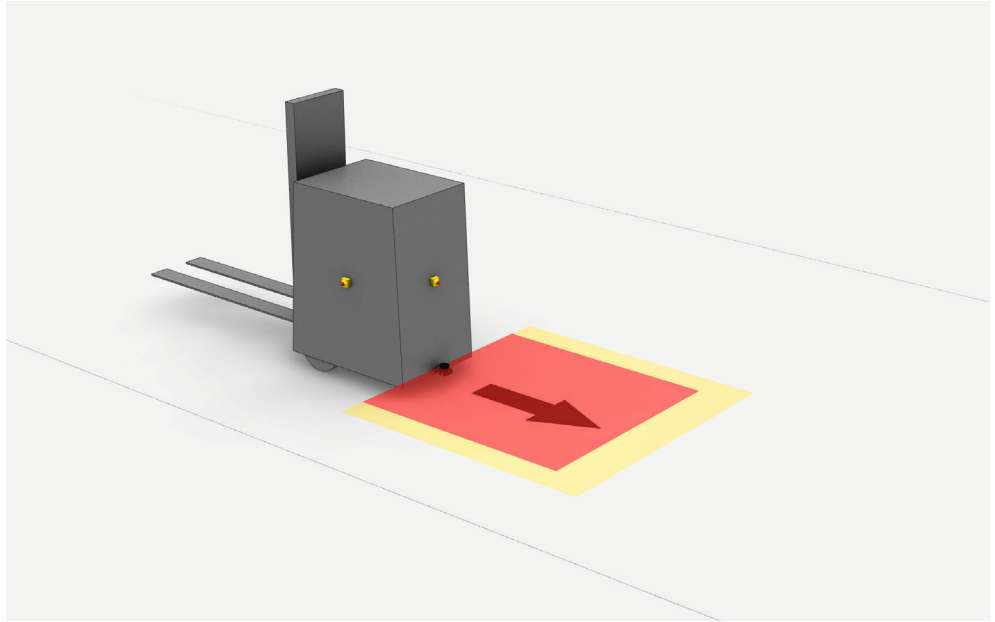

Figure 9: Mobile hazardous area protection: detection of a person when a vehicle approaches

4 Project planning

4.1 Manufacturer of the machine

The manufacturer of the machinery must carry out a risk assessment and apply appropriate protective measures. Further protective measures may be required in addition to the product.

The product must not be tampered with or changed, except for the procedures described in this document.

The product must only be repaired by the manufacturer of the product or by someone authorized by the manufacturer. Improper repair can result in the product not providing the expected protection.

4.2 Operating entity of the machine

Changes to the electrical integration of the product in the machine controller and changes to the mechanical mounting of the product necessitate a new risk assessment. The results of this risk assessment may require the entity operating the machine to meet the obligations of a manufacturer.

After each change to the configuration, it is necessary to check whether the protective measure provides the necessary protection. The person making the change is responsible for ensuring that the protection measure provides the necessary protection.

The product must not be tampered with or changed, except for the procedures described in this document.

The product must only be repaired by the manufacturer of the product or by someone authorized by the manufacturer. Improper repair can result in the product not providing the expected protection.

4.3 Design

Important information



DANGER

Hazard due to lack of effectiveness of the protective device

Persons or parts of the body to be protected may not be recognized or not recognized in time in case of non-observance.

- ▶ Make sure that there are no mirrors or other highly reflective objects in the protective field of the safety laser scanner.
 - ▶ Make sure that there is no smoke in the protective field of the safety laser scanner.
 - ▶ Prevent interference in the optical beam path. If, for example, the device is installed in a paneling, the viewing slit must be sufficiently large.
 - ▶ Do not use an additional front screen.
 - ▶ Ensure that there are no small objects (e.g. cables) in the protective field of the safety laser scanner, even if they do not trigger an object detection.
-

Prerequisites

- No obstacles interfere with the view in the protective field of the safety laser scanner. Where there are unavoidable obstacles, additional protective measures are applied.
- If people can stay between the protective device and the hazardous point without being detected, additional protective measures (e.g. restart interlock) are applied.
- Reaching under, over and around, crawling beneath and stepping over the safety laser scanner, as well as moving it, are prevented.

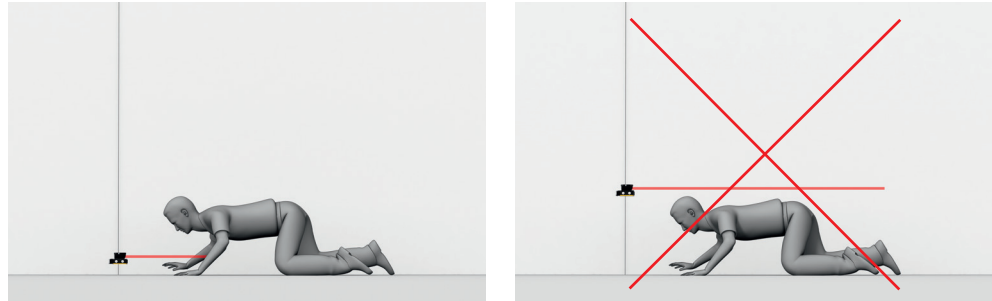

Figure 10: Prevent crawling beneath

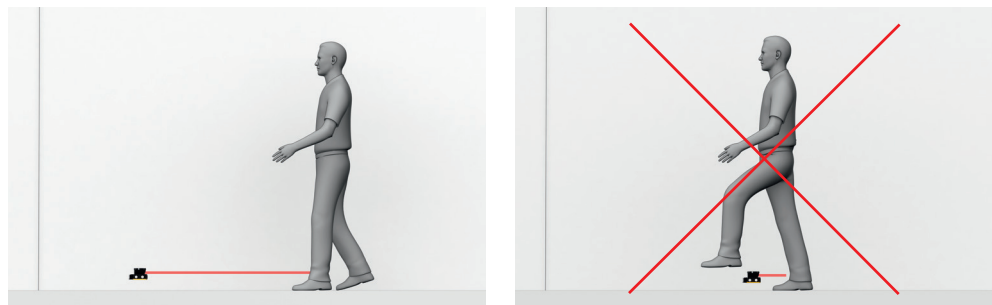

Figure 11: Prevent stepping over

Complementary information

Certain optical and electromagnetic ambient conditions can affect the safety laser scanner and thus reduce the availability of the machine.

Examples:

- Condensation on the optics cover
- Strong electrical fields (e.g. welding cables or induction cables)

Further topics

- ["Mounting", page 53](#)
- ["Dimensional drawings", page 131](#)

4.3.1 Protection from interference

Influence by laser

Laser sources located close to the machine can influence the safety laser scanner and thus reduce the availability of the machine.

Measures to increase availability:

- ▶ Avoid laser sources in the scan plane.
- ▶ Set multiple sampling to the highest value permitted in your application, taking the minimum distances into account, [see "Multiple sampling", page 70](#).

Influence by strong light sources

Strong external light sources in the scan plane can influence the safety laser scanner and thus reduce the availability of the machine.

Measures to increase availability:

- ▶ Avoid external light sources in the scan plane.
- ▶ Avoid direct sunlight in the scan plane.
- ▶ Do not position halogen lights, infrared light sources or stroboscopes directly on the scan plane.

Mutual interference from safety laser scanners

Due to the safeHDDM® scanning technology, mutual interference of multiple safety laser scanners is unlikely. If many safety laser scanners are operated at the same level in a stationary application, they may nevertheless interfere with one another. We recommend selecting a suitable mounting method to avoid mutual interference.

Suitable mounting methods:

- ▶ Offset mounting so that the scan planes are on different planes
- ▶ Slightly inclined, tilted mounting, so that the scan planes intersect one another

4.3.2 Preventing unprotected areas

Overview

The safety laser scanner must be mounted so that people cannot enter unsecured areas.

Undetected areas

There may be areas behind the safety laser scanner which cannot be detected by the safety laser scanner. The undetected areas become larger if the safety laser scanner is mounted using a mounting kit.

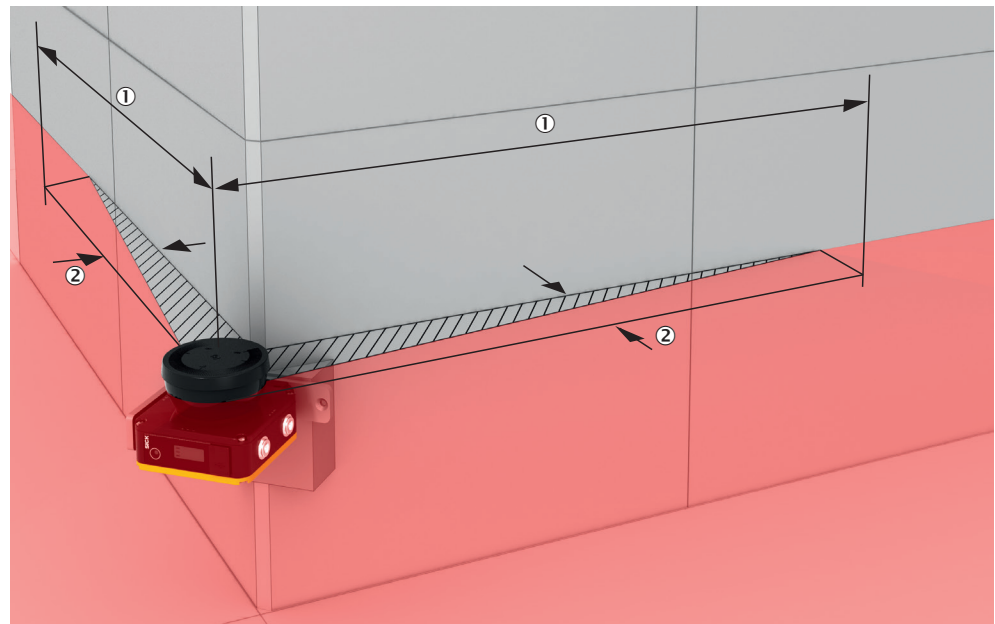

Figure 12: Unsecured areas

- ① Length of the undetected area
- ② Width of the undetected area

Remedial measures:

- Mounting of deflector plates to protect the undetected areas
- Mounting the safety laser scanner in the machine or vehicle paneling

Near range

In close proximity (50 mm-wide area in front of the optics cover), the detection capability of the safety laser scanner may be restricted. If required, this area must be secured using an undercut or frame, for example.

4.3.3 Reference contour monitoring**Vertical operation**

National and international standards require or recommend that a reference contour is monitored if the angle between access direction and scan plane exceeds 30°. With the reference contour field, the safety laser scanner monitors the distance to a contour of the environment (e.g. a wall) in order to detect inadvertent adjustment or manipulation.

Configuring the reference contour field during vertical operation

- In many cases, it makes sense to use the floor and lateral vertical passage boundaries (e.g. door frames) as a reference contour.
- The resolution of the reference contour field specifies how large a gap in the contour or an object in the reference contour field must be for the reference contour field to detect the gap or object in any case. Smaller gaps or objects can also trigger detection in some cases.
- The length of the monitored contour must be greater than the set resolution of the reference contour field.
- The reference contour field has an adjustable tolerance band. If the safety laser scanner does not detect the reference contour within the tolerance band, all safety outputs switch to the OFF state. In Safety Designer, you can define the tolerance band around the reference contour in both directions (near and far).
 - For high availability, setting both the positive tolerance band (far) and the negative tolerance band (near) to the TZ value is recommended. (TZ = tolerance zone of the safety laser scanner, see ["Data sheet", page 122.](#))
 - The tolerance band must not be too wide. The reference contour field must detect a deviation from the reference contour before access to the hazardous point occurs next to the protective field. Deviations may occur due to changes in position or orientation.
 - If the reference contour represents the edge of the protected opening, the sum of the negative and positive tolerance bands must not be greater than the resolution of the protective field.
 - If the reference contour does not represent the edge of the protected opening, the sum of the negative and positive tolerance bands must not be greater than the projection.
- You can define a number of contours in the reference contour field and therefore monitor various areas in the environment.

Protective field and reference contour field for hazardous point protection

The protective field must be larger than the protected opening. The required overrun (o) is calculated using the following formula:

$$o \geq (2 \times TZ) - d$$

Where:

- o = overrun of the protective field over the opening
- TZ = tolerance zone of the safety laser scanner, see ["Data sheet", page 122](#)
- d = set resolution

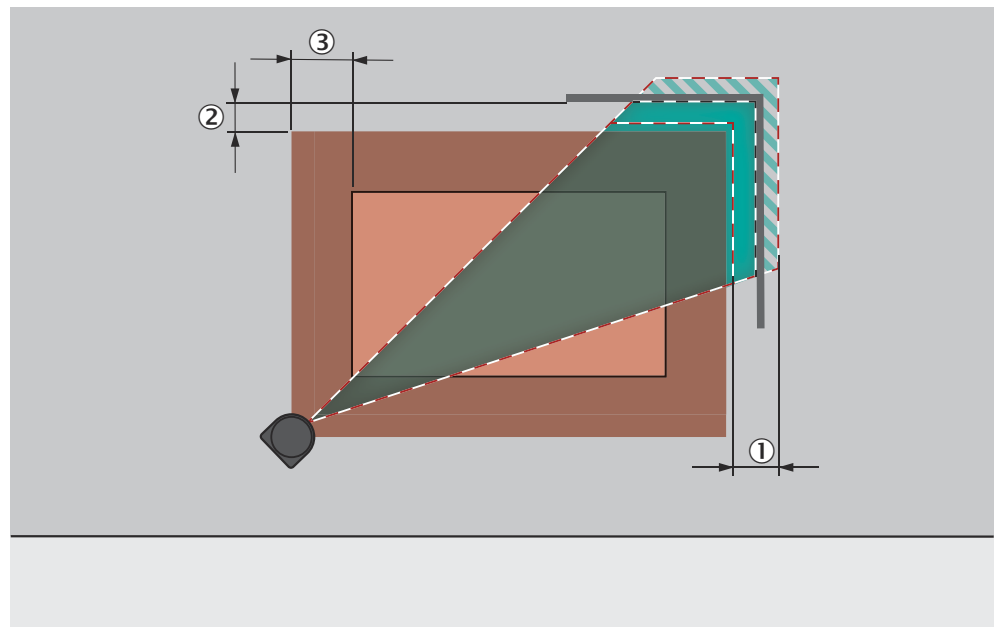

Figure 13: Overrun of the protective field in front of an opening

- ① Tolerance band of the reference contour field
- ② Distance of the protective field from the contour, to ensure availability
- ③ o = overrun of the protective field over the opening

Protective field and reference contour field for access protection

- If the reference contour represents the edge of the protected opening, its distance from the protective field must not exceed 100 mm. A distance equal to the TZ value is recommended for high availability and sufficient protection. (TZ = tolerance zone of the safety laser scanner, see "Data sheet", page 122.)
- If the reference contour does not represent the edge of the protected opening, the protective field must be larger than the protected opening. The required overrun (o) is calculated using the same formula as for hazardous point protection.

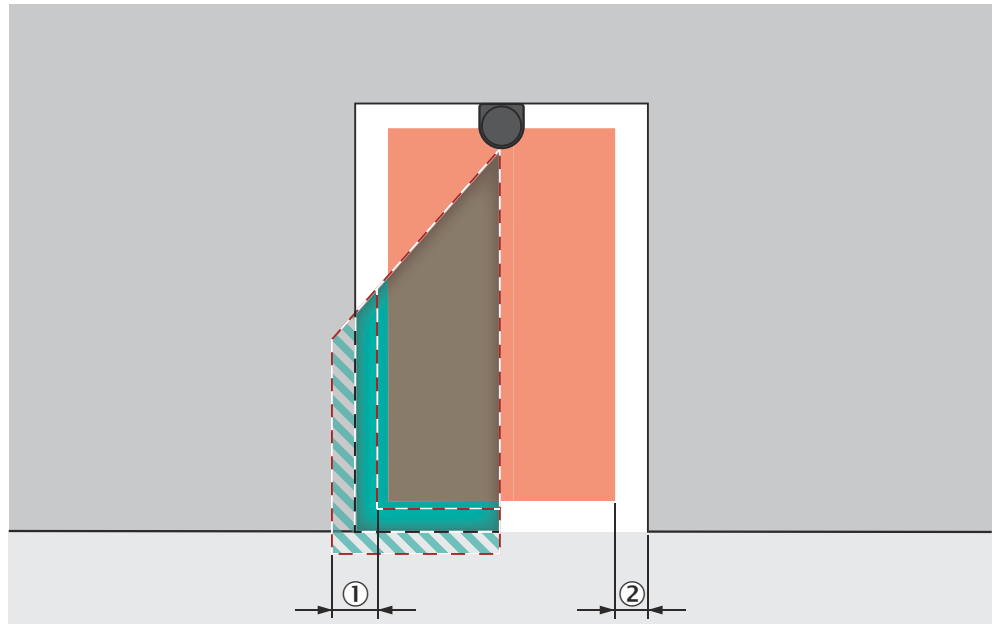

Figure 14: Tolerance band of the contour as reference field (protective field within the protected opening, edge of the protected opening = reference contour)

- ① Tolerance band of the reference contour field
- ② Distance of the protective field from the reference contour, to ensure availability

4.3.4 Monitoring case switching time

Overview

If you switch between monitoring cases, you must specify the time at which the switch-over takes place.

When determining the time, you must consider the following points, among others:

- At the time of switchover, one person can already be in the newly activated protective field. The new protective field must therefore be active in good time so that the device detects a person in the newly activated protective field before a hazard arises there.
- In some cases, the process of switching between monitoring cases takes so long that the new monitoring case is not available inside the response time provided. This means that it may not be possible to detect a person in the protective field in time. In cases like this, you must start switching between monitoring cases earlier.

The following parameters influence the duration of the process:

- Set input delay
- Processing time for the chosen input
- In addition to the parameters considered below, the switching signal's time-of-flight up to the device must also be taken into account. Depending on the communication protocol, these include the network cycle time and the processing time of a controller, for example.

Procedure

1. Calculate how long it takes to switch between monitoring cases:

$$t_{\text{CSR}} = t_{\text{ID}} + t_{\text{i}}$$

where:

- t_{CSR} = time required for switching between monitoring cases in milliseconds (ms)
- t_{ID} = input delay for the control inputs in milliseconds (ms)

- t_i = processing time for the selected switching type in milliseconds (ms)
 - Local control input: $t_i = 12$ ms
- 2. Calculate how much time is available in the response time for switching between monitoring cases:

$$t_{CSA} = (n - n_{CS}) \times t_S$$
 where:
 - t_{CSA} = time available for switching between monitoring cases in milliseconds (ms)
 - n = Multiple sampling setting (default: $n = 2$)
 - n_{CS} = multiple sampling after switching between monitoring cases (with setting **Fast** (presetting): $n_{CS} = 1$, with setting **Reliable**: $n_{CS} = n - 1$, with setting **User-defined**: $n_{CS} \leq n - 1$)
 - t_S = scan cycle time in milliseconds (ms)
- 3. Compare whether there is enough time available for switching between monitoring cases:
 - If $t_{CSA} \geq t_{CSR}$: earlier start is not necessary.
 - If $t_{CSA} < t_{CSR}$: switching between monitoring cases must start earlier. Required time advance t_{CSP} : $t_{CSP} = t_{CSR} - t_{CSA}$

Complementary information

- In some cases, it is not possible to define when to switch (for example because processing times of the machine vary) or the time advance means that the monitoring of an area finishes too early.

Remedial measures:

- Allow both protective fields to partially overlap.
- Temporarily monitor both hazardous areas simultaneously.

Further topics

- ["Input delay", page 87](#)

4.3.5 Minimum distance for stationary applications

Overview

The protective field must be designed to recognize a person, at the latest, when he or she reaches the minimum distance from the hazardous point. The minimum distance means that the dangerous state can be ended in good time before the person reaches the hazardous point.

Minimum distance for stationary applications

The calculation of the minimum distance is based on international or national standards and statutory requirements applicable at the place of installation of the machine.

If the minimum distance is calculated according to ISO 13855, then it depends on the following points:

- Machine stopping time (time interval between triggering the sensor function and the end of the machine's dangerous state, if necessary including signal propagation times in the network and processing time in the control)
- Response time of the protective device
- Reach or approach speed of the person
- Resolution (detection capability) of the safety laser scanner
- Type of approach: parallel for hazardous area protection, orthogonal for hazardous area protection and access protection
- Switching time between monitoring cases
- Parameters specified based on the application

- Supplements for general and, possibly, reflection-based measurement errors (only for hazardous area protection)
- Supplement for protection against reaching over (only for hazardous area protection)
- Height of the scan plane (only for hazardous area protection)
- Supplement to prevent reaching through (only for access protection)

Complementary information

Additional information is available in the ISO 13855 standard and in the Guide for Safe Machinery from SICK.

SICK offers a stopping/run-down time measurement service in many countries.

Further topics

- ["Response times", page 127](#)

4.3.6 Supplement Z_R for reflection-based measurement errors

If there is a retroreflector in the vicinity of the protective device (distance of the retroreflector from protective field ≤ 6 m), you must take the supplement $Z_R = 350$ mm into account.

4.3.7 Hazardous area protection

Overview

The safety laser scanner is mounted with a horizontal scan plane in a stationary application. This is, for example, on a machine where the hazardous area is not completely surrounded by a physical guard.

During hazardous area protection, the safety laser scanner detects a person's legs. The protective field is parallel to the direction of approach.

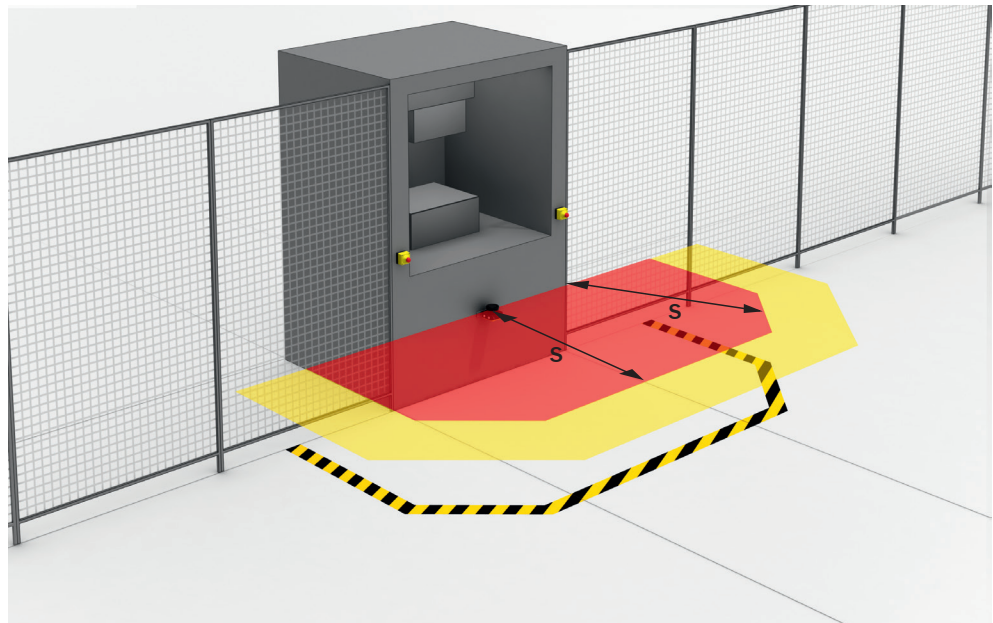

Figure 15: Stationary application with horizontal scan plane for hazardous area protection

Complementary information

It is recommended to mark the course of the protective field boundaries on the floor. By doing this, you allow machine operators to see the protective field boundaries and make it easier to thoroughly check the protective function at a later date.

4.3.7.1 Protective field

In hazardous area protection, the minimum distance typically defines the protective field size required.

If you define a number of monitoring cases with different protective fields, you must calculate the protective field size separately for each protective field used.

In many cases, a resolution of 50 mm to 70 mm is suitable for hazardous area protection. Resolutions coarser than 70 mm are not permitted.

4.3.7.2 Supplement C_{RO} to protect against reaching over

Overview

Under certain circumstances, a person can reach the hazardous area by reaching over, before the protective device stops the dangerous state. The supplement C_{RO} prevents this.

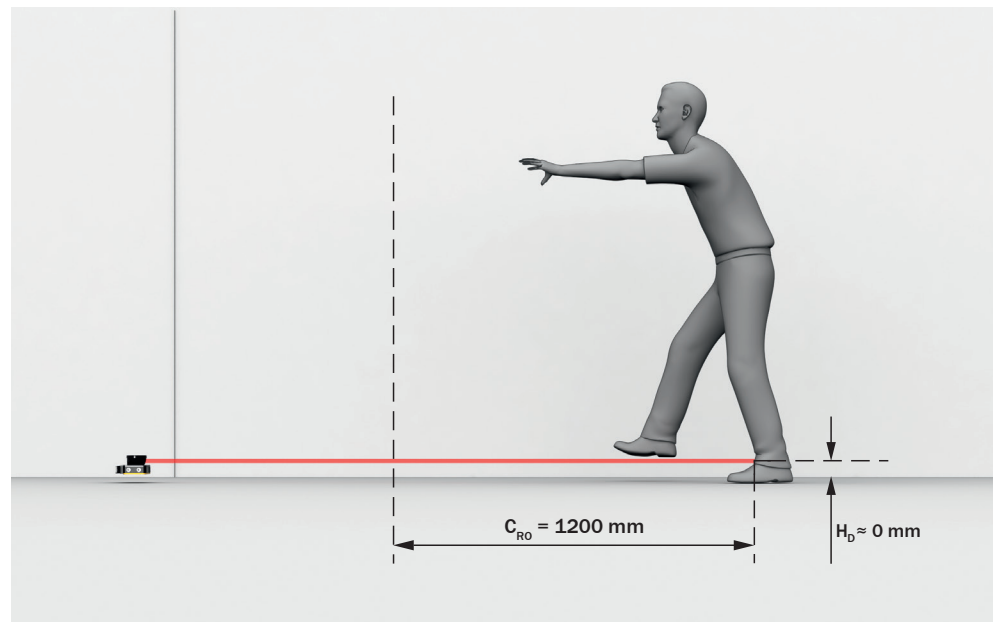

Figure 16: Protection against reaching over with low scan plane (dimensions in mm)

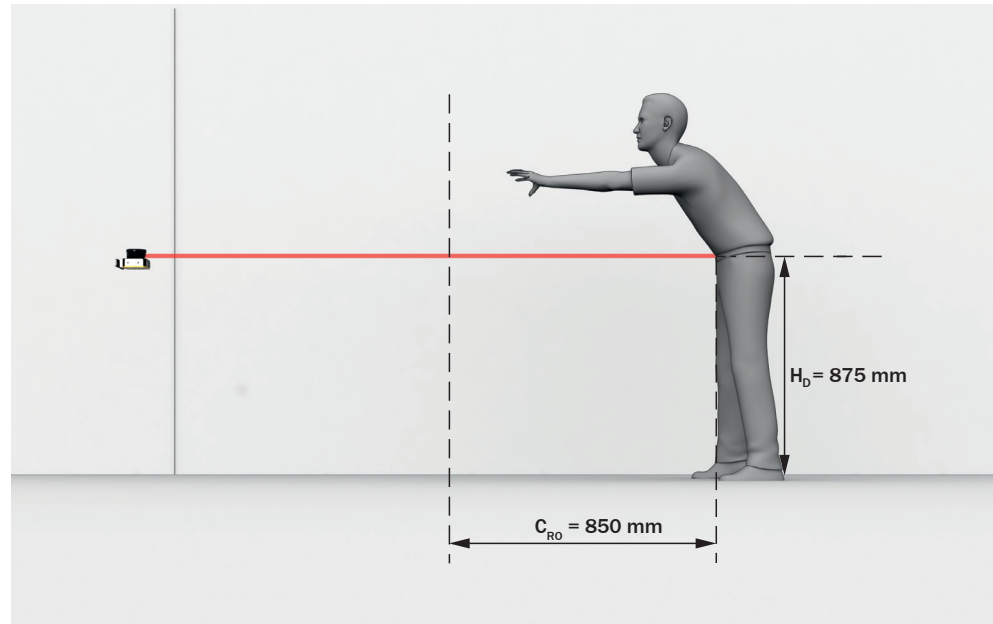

Figure 17: Protection against reaching over with high scan plane (dimensions in mm)

The necessary supplement to the minimum distance depends on the height of the protective field's scan plane. With a low scan plane, the supplement is greater than with a high scan plane.

Calculating the supplement C_{RO}

- ▶ If there is sufficient space in front of the hazardous area, use $C_{RO} = 1,200$ mm.
- ▶ If the minimum distance should be as small as possible, calculate C_{RO} using the following formula:

$$C_{RO} = 1,200 \text{ mm} - (0.4 \times H_D)$$
 where:
 - H_D = height of the protective field above the floor in millimeters (mm).
- ✓ If the result is $C_{RO} \geq 850$ mm, then use the calculated value as supplement C.
- ✓ If the result is $C_{RO} < 850$ mm, then use $C_{RO} = 850$ mm (this value corresponds to an arm's length and is valid as a minimum supplement to protect against reaching over).

4.3.7.3 Calculation example for the minimum distance

Calculation example of the minimum distance S according to ISO 13855

The example shows the calculation of the minimum distance S for parallel approach to the protective field. A different calculation may be required, depending on the application and the ambient conditions (e.g. for a protective field orthogonal to or at any angle to the direction of approach or an indirect approach).

$$S = 1,600 \text{ mm/s} \times T + TZ + Z_R + C_{RO}$$

where:

- S = minimum distance in millimeters (mm)
- T = stopping/run-down time for the entire system in seconds (s)
(Response time of the safety laser scanner + machine stopping time, incl. response time of the machine control system and signal propagation time)
- TZ = tolerance zone of the safety laser scanner, see "Data sheet", page 122

- Z_R = supplement for reflection-based measurement errors in millimeters (mm), see ["Supplement \$Z_R\$ for reflection-based measurement errors"](#), page 27
- C_{RO} = supplement to protect against reaching over in millimeters (mm), see ["Supplement \$C_{RO}\$ to protect against reaching over"](#), page 28

The reach/approach speed is already included in the formula.

4.3.7.4 Height of the scan plane

Overview

If you mount the safety laser scanner at a height of at least 300 mm (height of the scan plane), the scan plane is at calf height and the leg is detected at a resolution of 70 mm (see [figure 18, page 30](#)).

If the scan plane is lower than 300 mm, you must use a resolution finer than 70 mm.

The scan plane must not be higher than 1,000 mm.

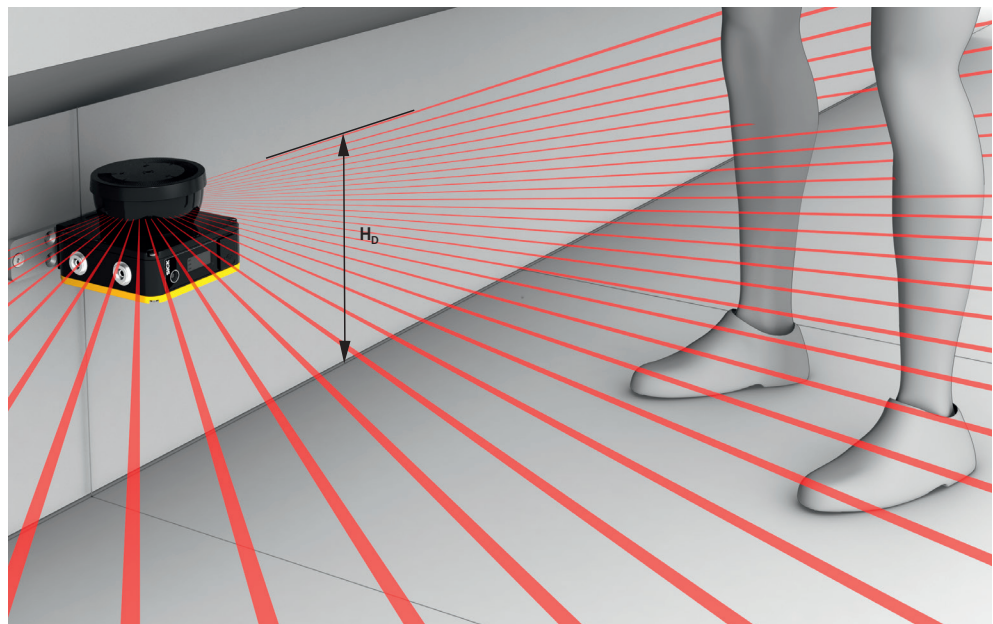

Figure 18: Scan plane at calf height

Calculating required resolution

If the height of the protective field (scan plane) is predefined and is less than 300 mm, you can calculate the required resolution using the following formula:

$$d_r = H_D / 15 + 50 \text{ mm}$$

where:

- d_r = coarsest permissible resolution of the safety laser scanner in millimeters (mm)
- H_D = height of the protective field above the floor in millimeters (mm)

The safety laser scanner's resolution can be set to the predefined value d . If the result d_r does not match any of these values, you must choose a finer resolution ($d \leq d_r$).

4.3.7.5 Distance from walls

The availability may be impaired if the protective field stretches as far as a wall or a different object. So, a space between the protective field and the object is required. A distance of the TZ value is recommended to ensure availability. (TZ = tolerance zone of the safety laser scanner, see ["Data sheet"](#), page 122.)

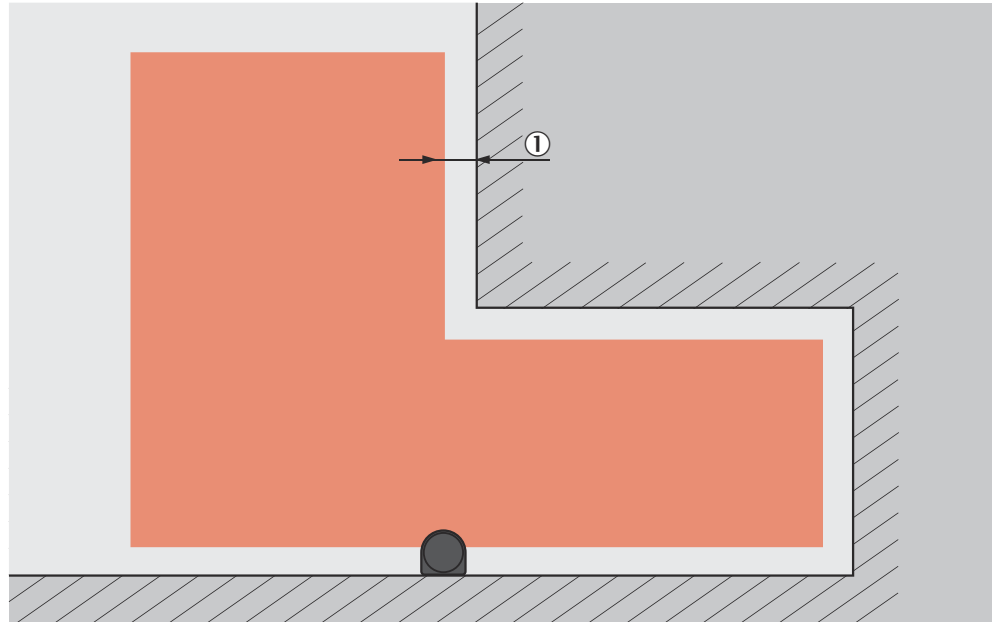

Figure 19: Distance of the protective field from the wall

- ① Recommended distance of the protective field from the wall.

If the distance between the protective field and the wall is so large that a person can stand in it, this person might not be detected. In this case, appropriate measures are required to prevent it, e.g. deflector plates or a fence.

4.3.8 Hazardous point protection

Overview

The safety laser scanner is mounted with a vertical scan plane in a stationary application. This is, for example, on a machine where the operator must stay close to the hazardous point. A fixed barrier with a height of at least 1200 mm is located in front of the hazardous point. The operator can reach over the barrier and through the scan plane into the hazardous point. But the operator cannot climb over the barrier. If there is no such barrier available, access protection may be required.

During hazardous point protection, the safety laser scanner detects a person's hand or other part of their body of at least the same size. The protective field is orthogonal to the direction of approach.

You must monitor a reference contour to protect the safety laser scanner from accidental misalignment or manipulation.

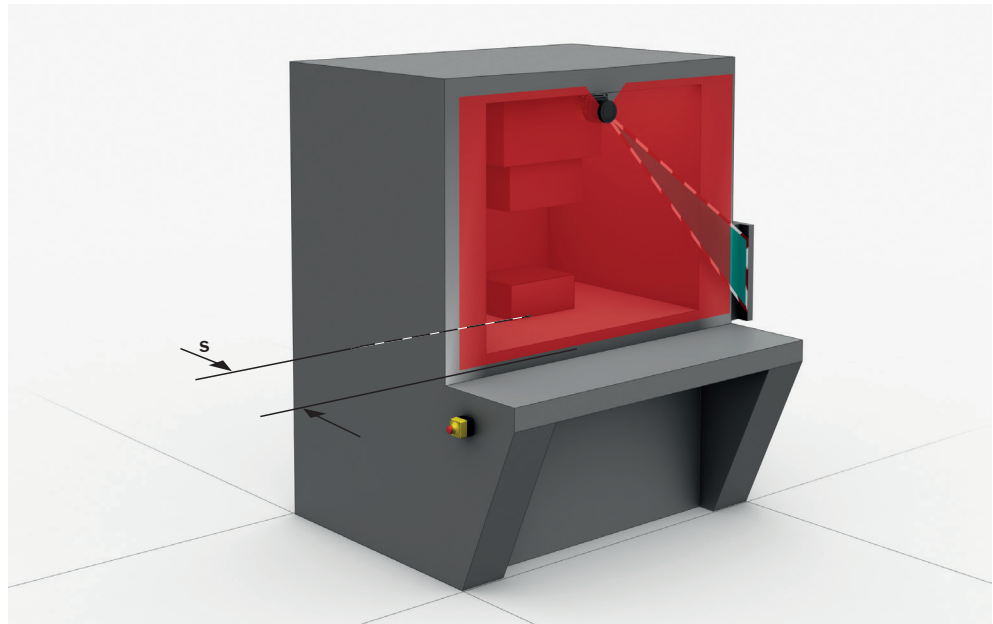

Figure 20: Stationary application in vertical operation for hazardous point protection

Important information



DANGER

Hazard due to lack of effectiveness of the protective device

If there is a retroreflector in the protective field level (distance of the retroreflector from protective field ≤ 6 m), it may not be possible to detect people and parts of the body that are to be protected, or it may not be possible to detect them on time.

- ▶ Avoid retroreflectors in the protective field level if possible.
- ▶ With retroreflectors at the protective field level: Increase overrun of the protective field over the opening to be protected by supplement $Z_R = 350$ mm.

4.3.8.1 Protective field

In hazardous point protection, the minimum distance typically defines the position at which the safety laser scanner is mounted. Access to the hazardous point shall only be possible through the protective field.

In many cases, a resolution of 20 mm, 30 mm or 40 mm is suitable for hazardous point protection. A resolution of 40 mm or finer is required to ensure detection of the hand during hazardous point protection. The safety laser scanner is not suitable for finger detection, because the finest resolution is 20 mm.

Complementary information

The required minimum distance depends on the safety laser scanner's set resolution.

Notes on selecting the resolution:

- If you choose a fine resolution, the protective field range is smaller and the protective field is only suitable for smaller hazardous points. But the required minimum distance is smaller, you can mount the safety laser scanner closer to the hazardous point.
- If you choose a coarser resolution, the protective field range is larger and the protective field is also suitable for larger hazardous points. But the required minimum distance is larger, you must mount the safety laser scanner further away from the hazardous point.

4.3.8.2 Calculation example for the minimum distance

Calculation example of the minimum distance S according to ISO 13855

The example shows the calculation of the minimum distance for an orthogonal approach to the protective field. A different calculation may be required depending on the application and the ambient conditions, e.g. for a protective field parallel to or at any angle to the direction of approach or an indirect approach.

- ▶ First, calculate S using the following formula:

$$S = 2,000 \text{ mm/s} \times T + 8 \times (d - 14 \text{ mm})$$
 where:
 - S = minimum distance in millimeters (mm)
 - T = stopping/run-down time for the entire system in seconds (s)
 (Response time of the safety laser scanner + machine stopping time, incl. response time of the machine control system and signal propagation time)
 - d = resolution of the safety laser scanner in millimeters (mm)
- ✓ If the result is $S \leq 100 \text{ mm}$, use $S = 100 \text{ mm}$.
- ✓ If the result is $100 \text{ mm} < S \leq 500 \text{ mm}$, use the calculated value as the minimum distance.
- ▶ If the result is $S > 500 \text{ mm}$, then recalculate S with the following formula:

$$S = 1,600 \text{ mm/s} \times T + 8 \times (d - 14 \text{ mm})$$
- ✓ If the new value is $S > 500 \text{ mm}$, then use the newly calculated value as the minimum distance.
- ✓ If the new value is $S \leq 500 \text{ mm}$, then use $S = 500 \text{ mm}$ as the minimum distance.

The reach/approach speed is already included in the formula.

4.3.9 Access protection

Overview

In a stationary application, for example on a machine where the point of access to the hazardous area can be physically defined, the safety laser scanner is mounted with a vertical scan plane.

For access protection, the safety laser scanner detects an intrusion by a whole body. The protective field is orthogonal to the direction of approach.

You must monitor a reference contour to protect the safety laser scanner from accidental misalignment or manipulation.

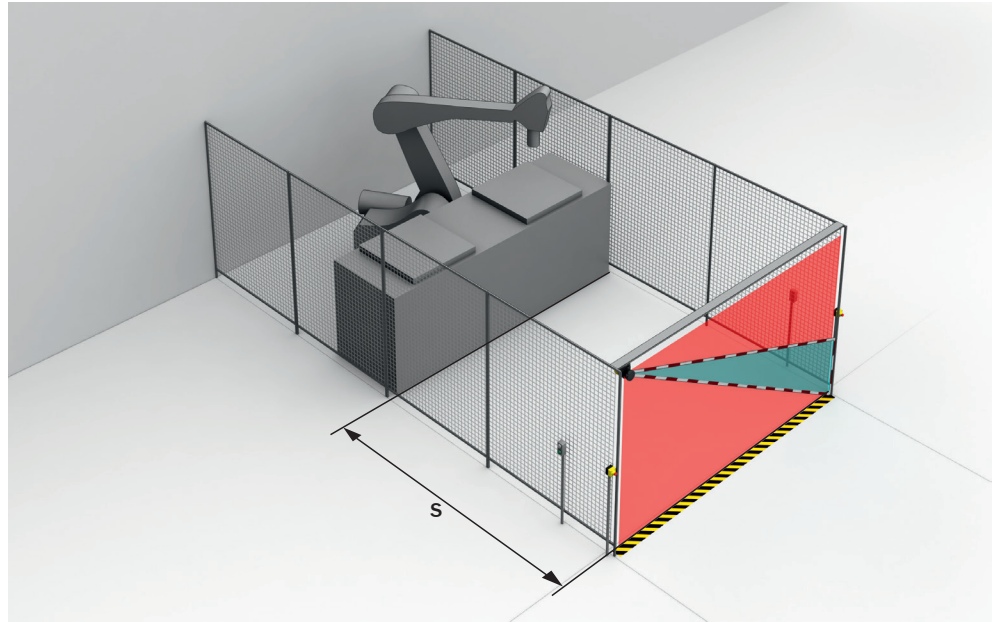

Figure 21: Stationary application in vertical operation for access protection

Important information



DANGER

Hazard due to lack of effectiveness of the protective device

If there is a retroreflector in the protective field level (distance of the retroreflector from protective field ≤ 6 m), it may not be possible to detect people and parts of the body that are to be protected, or it may not be possible to detect them on time.

- ▶ Avoid retroreflectors in the protective field level if possible.
- ▶ With retroreflectors at the protective field level: Increase overrun of the protective field over the opening to be protected by supplement $Z_R = 350$ mm.

4.3.9.1 Protective field

In access protection, the minimum distance typically defines the position at which the safety laser scanner is mounted.

The protective field must cover a minimum area so that the safety laser scanner reliably detects a moving person:

- The lower edge of the protective field must not be more than 300 mm above the floor/ground according to ISO 13855.
- Resolution < 150 mm: The top edge of the protective field must be at least 900 mm above the floor/ground according to ISO 13855.
- Resolution 150 mm: The top edge of the protective field must be at least 1,100 mm above the floor/ground.
- Resolution 200 mm: The top edge of the protective field must be at least 1,400 mm above the floor/ground.

The multiple sampling must be 2 or 3. Otherwise, a person could possibly walk undetected through the protective field.

4.3.9.2 Calculation example for the minimum distance

Calculation example of the minimum distance S according to ISO 13855

The example shows the calculation of the minimum distance for an orthogonal approach to the protective field. A different calculation may be required, depending on the application and the ambient conditions (e.g. for a protective field parallel to or at any angle to the direction of approach or an indirect approach).

$$S = 1,600 \text{ mm/s} \times T + 850 \text{ mm}$$

where:

- S = minimum distance in millimeters (mm)
- T = stopping/run-down time for the entire system in seconds (s)
(Response time of the safety laser scanner + machine stopping time, incl. response time of the machine control system and signal propagation time)

The approach speed is already included in the formula.

4.3.10 Mobile hazardous area protection

The safety laser scanner is mounted with a horizontal scan plane in a mobile application, like on an automated guided vehicle. In mobile hazardous area protection, the safety laser scanner protects the hazardous area created by the vehicle's movement.

The safety laser scanner detects a person's legs. The protective field is parallel to the direction of approach.

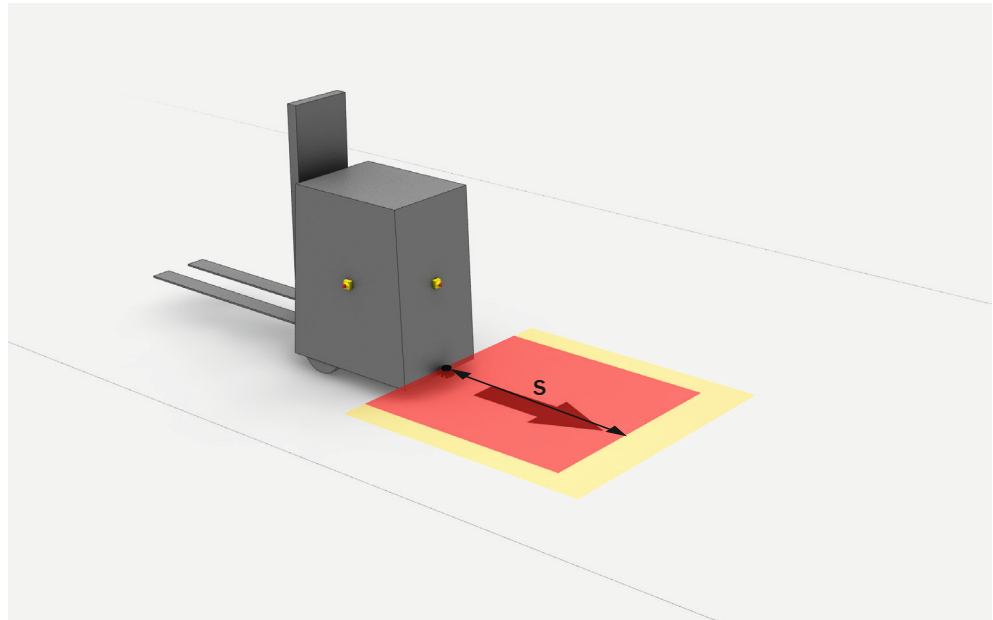

Figure 22: Mobile application in horizontal operation for hazardous area protection



NOTE

- In a mobile application, a resolution of 70 mm (leg detection) is sufficient for detecting people. By contrast with stationary hazardous point protection, this is also true for a low mounting height, as the safety laser scanner moves together with the vehicle.
- In the following calculation examples, only the vehicle speed is taken into account, not the speed of a walking person. This is based on the assumption that the person recognizes the danger and stands still.

4.3.10.1 Protective field

The protective field must be designed in such a way that it recognizes a person at the latest when he or she is at the minimum distance from the hazardous point. The minimum distance allows the vehicle to stop in time before it reaches a person or an object.

In mobile hazardous area protection, the minimum distance typically defines the protective field length required. When calculating the protective field length, the impact of turning must be considered separately.

The protective field must be wide enough to cover the width of the loaded vehicle with supplements for measurement error and the lack of ground clearance. When calculating the protective field width, the impact of turning must be considered separately.

If you define a number of monitoring cases with different protective fields, you must calculate the protective field size separately for each protective field used.

4.3.10.2 Supplement Z_F for lack of ground clearance

This supplement is necessary, because, generally, a person is detected above the foot and the braking process cannot take account of the length of the foot in front of the point of detection. A person's foot could be injured if a vehicle has no ground clearance.

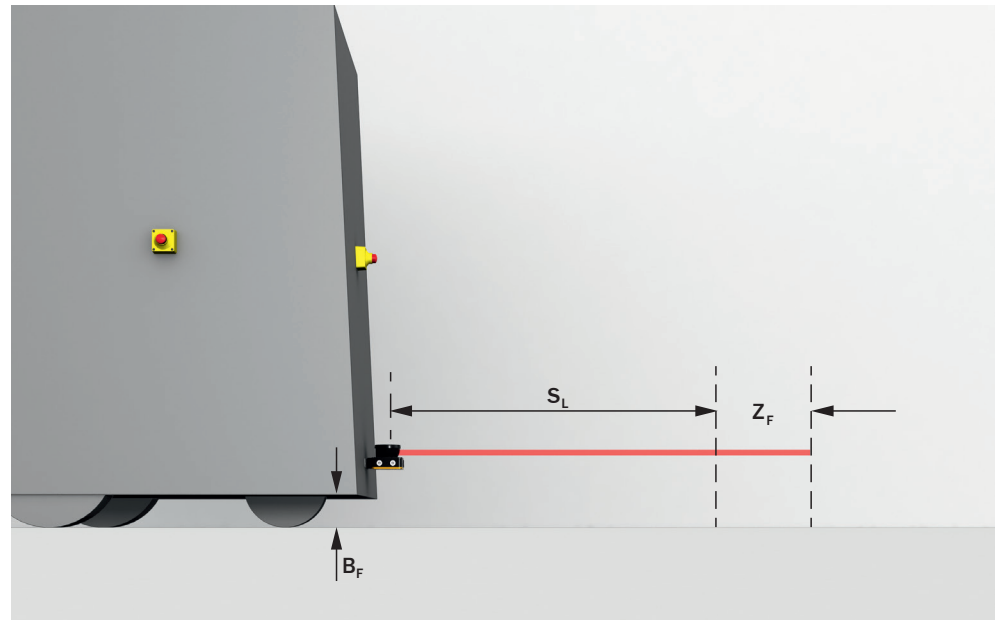

Figure 23: Flat-rate supplement for lack of ground clearance

- B_F Ground clearance
- S_L Protective field length without a supplement for lack of ground clearance
- Z_F Supplement for lack of ground clearance

The lump supplement for ground clearance under 120 mm is 150 mm. This supplement may be reduced further in individual cases, [see figure 24, page 37](#).

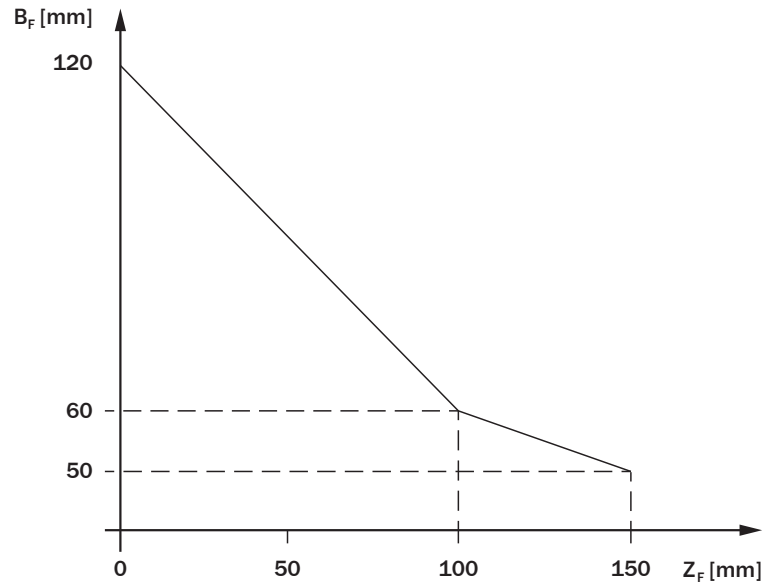

Figure 24: Minimum supplement for lack of ground clearance

B_F Ground clearance in mm
 Z_F Supplement for lack of ground clearance in mm

4.3.10.3 Stopping distance S_A

The stopping distance is the sum of the following distances:

- Braking distance of the vehicle
- Distance covered during the response time of the safety laser scanner
- Distance covered during the response time of the vehicle control (incl. signal propagation time)

A vehicle's braking distance does not increase linearly with increasing speed, but rather in a squared relationship.

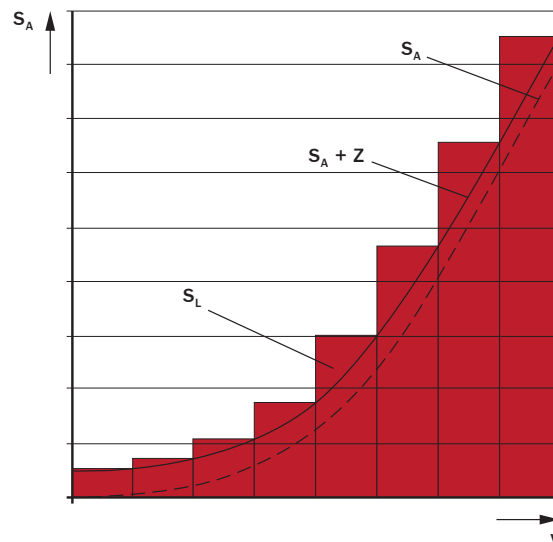

Figure 25: Stopping distance as a function of the vehicle's speed

- v Speed
- S_A Stopping distance
- Z Supplements
- S_L Protective field length for the relevant range of speeds

$$S_A = S_{Br} + S_{AnF} + S_{AnS}$$

where:

- S_A = stopping distance in millimeters (mm)
- S_{Br} = braking distance, from the vehicle documentation, in millimeters (mm)
- S_{AnF} = distance covered during the vehicle control's response time (including signal propagation time), from the vehicle documentation, in millimeters (mm)
- S_{AnS} = distance covered during the response time of the safety laser scanner in millimeters (mm)

The distance S_{AnS} depends on the safety laser scanner's response time and the vehicle's speed. The distance S_{AnS} is calculated using the following formula:

$$S_{AnS} = t_R \times V_{max}$$

where:

- t_R = response time of the safety laser scanner in seconds (s)
- V_{max} = maximum speed of the vehicle, from the vehicle documentation, in millimeters per second (mm/s) (If you define a number of monitoring cases with different protective fields: V_{max} = maximum speed of the vehicle in the current monitoring case)

Further topics

- ["Response times", page 127](#)

4.3.10.4 Calculation example for the protective field length

Calculation example for the protective field length S_L

$$S_L = S_A + TZ + Z_R + Z_F + Z_B$$

where:

- S_L = protective field length in millimeters (mm)
- S_A = stopping distance in millimeters (mm)
- TZ = tolerance zone of the safety laser scanner, [see "Data sheet", page 122](#)
- Z_R = supplement for reflection-based measurement errors in millimeters (mm)
- Z_F = supplement for lack of ground clearance of the vehicle in millimeters (mm)
- Z_B = supplement for the decreasing braking force of the vehicle, from the vehicle documentation, in millimeters (mm)

4.3.10.5 Calculation example for the protective field width

Calculation example for the protective field width S_B

$$S_B = F_B + 2 \times (TZ + Z_R + Z_F)$$

where:

- S_B = protective field width in millimeters (mm)
- F_B = vehicle width in millimeters (mm)
- TZ = tolerance zone of the safety laser scanner, [see "Data sheet", page 122](#)
- Z_R = supplement for reflection-based measurement errors in millimeters (mm)
- Z_F = supplement for lack of ground clearance of the vehicle in millimeters (mm)

4.3.10.6 Height of the scan plane

The scan plane must be at a maximum height of 200 mm everywhere. Otherwise, persons lying horizontally may not be detected.

In many cases, a mounting height of 150 mm above the floor (height of the scan plane) is suitable.

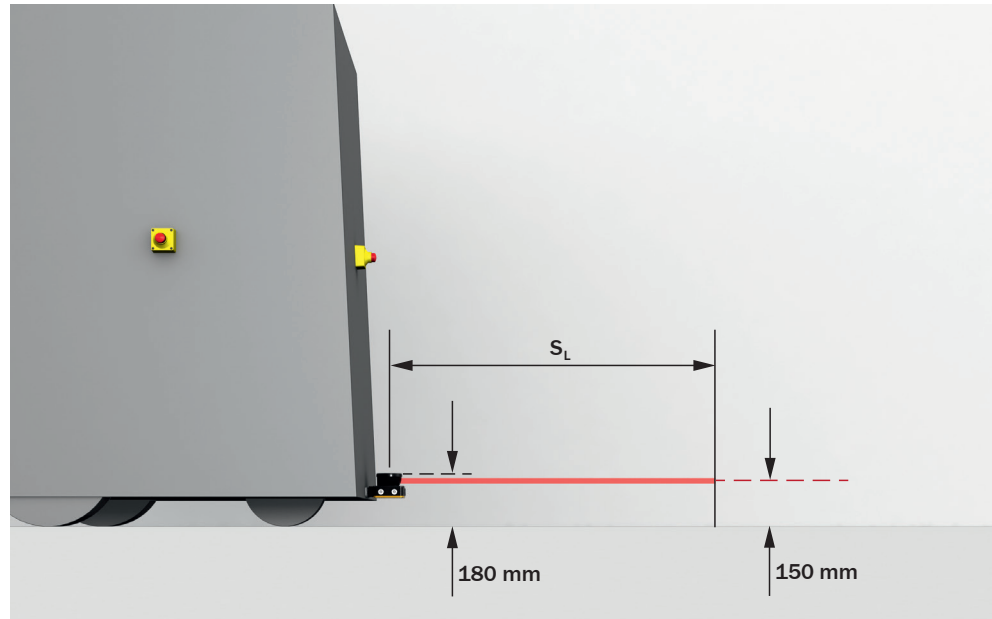

Figure 26: Recommended fitting height

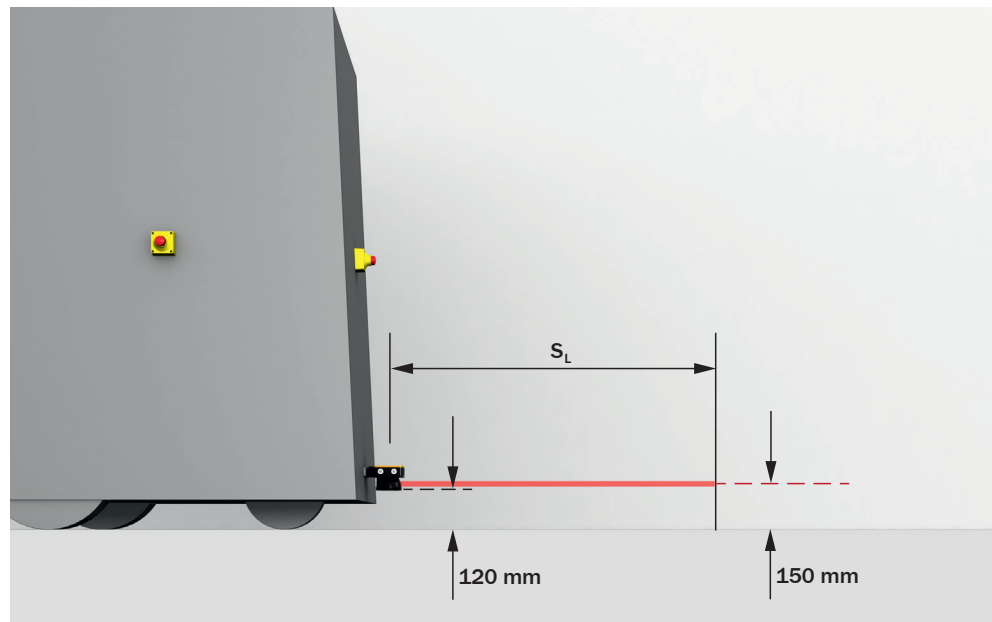

Figure 27: Recommended fitting height for inverted mounting

4.4 Integration in the electrical control system

Requirements for use

- The control of the machine can be electrically influenced.
- The connected controller and all devices responsible for safety comply with the required performance level and the required category (for example according to ISO 13849-1).
- Power is supplied to all electrically connected devices in accordance with SELV/PELV (IEC 60204-1).
- All devices connected to a local input or output are in the same SELV/PELV circuit as the product.
- All electrically connected devices use the same earthing method.
- All earthing points are connected with the same ground potential.

Further topics

- ["Electrical installation", page 55](#)

4.4.1 Electromagnetic compatibility

Overview

Safety components switch all safety outputs to the OFF state in the event of errors in order to rule out potentially dangerous situations. For example, faulty data transmission must lead to a shutdown for safety-related devices, even if it can be tolerated for non-safety-related devices.

To avoid electromagnetic interference as much as possible, a consistent earthing method is required for the entire system. In particular, the functional earth must be connected using suitable conductors. Cables susceptible to interference and sources of interference should be routed separately.

Electromagnetic interference depends on the environment in which the product is used. The product is tested and certified according to common standards. It is therefore reliable when used in industrial environments.

Shielded cables

For shielded cables, the shielding should be applied on both sides and over a large area. Deviations are only permitted in exceptional and justified cases. Especially when using motors or other inductive consumers, one-sided support of the shielding is not sufficient because it does not act against inductive interferers.

Functional earth

The functional earth must be connected. The connection must be made in accordance with the earthing method of the system.

Options for connecting the functional earth:

- 8-pin plug connector for voltage supply and inputs and outputs: pin 8 or thread on the M12 plug connector
- 17-pin plug connector for voltage supply and inputs and outputs: thread on the M12 plug connector
- Flying leads: Shielding of connecting cable
- M5 threaded holes on the housing

The functional earth must be connected with low inductance, i.e. with a sufficient wire cross-section and the shortest possible length of cable.

4.4.2 Voltage supply

Prerequisites

- The power supply unit is able to jumper a brief power failure of 20 ms as specified in IEC 60204-1.
- The power supply unit provides safe isolation according to IEC 61140 (SELV/PELV as per IEC 60204-1).
- The electrical power supply has an appropriate electrical fuse.

Further topics

- ["Data sheet", page 122](#)

4.4.3 USB connection

The device has a USB connection for configuration and diagnostics. The USB connection complies with the USB 2.0 Micro-B standard (female connector). The USB connection may only be used temporarily and only for configuration and diagnostics.

Further topics

- ["Configuration", page 60](#)
- ["Troubleshooting", page 112](#)

4.4.4 OSSDs

Overview

When the protective field is clear, the OSSDs signal the ON state and the signal level is HIGH (non-isolated). If there are objects in the protective field or there is a device error, the OSSDs signal the OFF state with the LOW signal level.

Downstream control elements must evaluate the output signals of the protective device in such a way that the dangerous state of the machine is safely ended. Depending on the safety concept, the signal is analyzed by safety relays or a safety controller, for example.

The OSSDs are short-circuit proof against 24 VDC and 0 V.

Prerequisites

- The machine switches to the safe state if, at any time, at least one OSSD in an OSSD pair switches to the OFF state.
- When using a safety controller: The safety controller detects different signal levels of the two OSSDs of an OSSD pair (depending on national regulations or required reliability of the safety function). The maximum discrepancy time tolerated by the control is selected according to the application.
- The output signals from an OSSD pair are not connected to each other.
- The machine controller processes both signals of an OSSD pair separately.

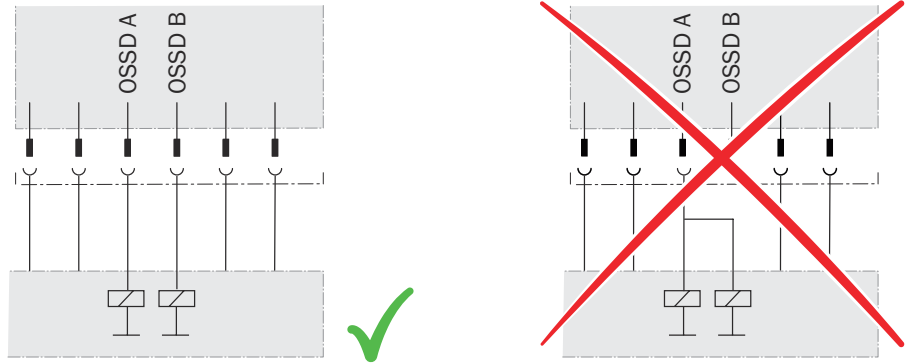

Figure 28: Dual-channel and isolated connection of an OSSD pair

- No potential difference can occur between the load and the protective device. The 0 V connections of the load and those of the associated protective device are connected individually and directly to the same 0 V terminal strip. In the event of an error, this is the only way to ensure that there can be no potential difference between the 0 V connections of the loads and those of the corresponding protective device. This is particularly important for loads that switch even if they are activated with negative voltage (e.g. electromechanical contactor without reverse polarity protection diode).

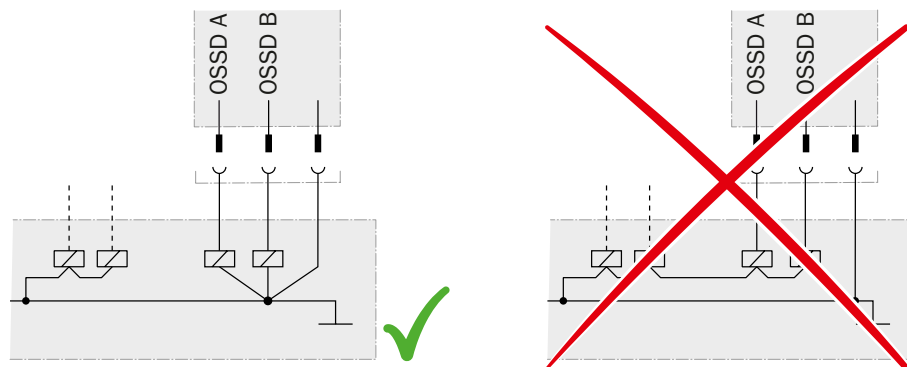

Figure 29: No potential difference between load and protective device

4.4.5 Control inputs

Overview

Local control inputs accept signals for switching between different monitoring cases:

- Static control inputs are used for information about machine status.
- Dynamic control inputs are usually used for information about the speed of a vehicle.

Prerequisites

- The safety-related parts of the control which switch the active protective field provide the same safety level as the safety function. In many cases, this is PL d as per ISO 13849-1 or SIL2 as per IEC 62061.
- Position-dependent switching is carried out by 2 independently wired signal sources, such as 2 independent position switches.
- Speed-dependent switching is carried out by two independently wired signal sources, such as two independent incremental encoders.
- Manual switching that depends on the operating mode is carried out using a suitable manual control switch.

Further topics

- ["Data sheet", page 122](#)
- ["Electrical installation", page 55](#)
- ["Inputs and outputs, local", page 82](#)

4.4.5.1 Static control inputs**Overview**

The static control inputs support the following evaluation methods:

- Complementary evaluation
- 1-out-of-n evaluation (only devices with several static control inputs)

Complementary evaluation

A static control input consists of 2 channels in the case of complementary sampling. The channels of a static control input are switched inversely. The following table shows which status the static control input's channels must have to define logical input condition 1 and 0 at the relevant control input.

Table 3: Status of the channels of the control inputs with complementary evaluation

| A1 | A2 | Logical input status (input A) |
|----|----|--------------------------------|
| 1 | 0 | 0 |
| 0 | 1 | 1 |
| 1 | 1 | Error |
| 0 | 0 | Error |

1-of-n evaluation

With the 1-out-of-n evaluation, each channel of a control input is considered individually. At any time, exactly one channel must have logic value 1.

Table 4: True vales with 1-off-n-evaluation with 2 input pairs (example)

| A1 | A2 | B1 | B2 | Result (e.g. monitoring case no.) |
|------------------------|----|----|----|-----------------------------------|
| 1 | 0 | 0 | 0 | 1 |
| 0 | 1 | 0 | 0 | 2 |
| 0 | 0 | 1 | 0 | 3 |
| 0 | 0 | 0 | 1 | 4 |
| Other input conditions | | | | Error |

Complementary information

- When the input signal is changed, the previous monitoring case remains active for the duration of the set switch-on delay. If no valid input signal is present after the switch-on delay has elapsed, the behavior depends on the sequence monitoring:
 - If monitoring of the switching sequence (sequence monitoring) is not activated, the OSSDs switch to the OFF state after the switch-on delay has elapsed. If a valid input signal is present within another second, the safety laser scanner activates the new monitoring case. If no valid input signal is present within this time, the OSSDs remain in the OFF state and the safety laser scanner displays an error and must be restarted.
 - If monitoring of the switching sequence (sequence monitoring) is activated, the OSSDs switch to the OFF state after the switch-on delay has elapsed and the safety laser scanner displays an error and must be restarted.

- A short-circuit or cross-circuit on one or more channels of the static control inputs can cause the wrong monitoring case to be activated.
 - Some safety controllers detect the short-circuit or cross-circuit and switch off the outputs concerned or all their outputs.
 - Due to the short-circuit or cross-circuit, one or more input channels of the safety laser scanner can still deliver the HIGH signal level. This may result in a valid input signal so that a monitoring case is activated.
 - For this reason, laying the cables for the input signals in a protected manner is recommended. Otherwise, setting the switch-on delay to 0 s and activating sequence monitoring is recommended. Carrying out regular thorough check at short intervals is also recommended.

Further topics

- ["Settings for monitoring case tables", page 86](#)
- ["Configure switching sequence", page 87](#)

4.4.5.2 Dynamic control inputs

Overview

A dynamic control input receives speed information from an incremental encoder.

Important information



WARNING

Failure of both encoders due to a common cause

If both encoders fail at the same time, the device will receive no speed information. Therefore, the device switches to the monitoring case defined for standstill, although the vehicle may be moving.

- ▶ Exclude errors with a common cause in the encoders.
-

Prerequisites

- Defects of an incremental encoder are detected. Therefore, 2 incremental encoders are used which function independently of one another and transmit their signals on separate pathways.
- Only a single safety laser scanner is connected to each incremental encoder.
- Each incremental encoder (with one wire each for 0° and 90°) is connected to only one control input.
- Each incremental encoder is supplied with voltage via its own supply line.
- Errors with a common cause on both encoders are excluded.

Possible measures:

- Each encoder has its own electrical power supply and its own supply line in its own sheathed cable.
- Both encoders and the device have a common electrical power supply at a protected location (e.g. in the control cabinet). Each encoder and device has its own supply line in its own sheathed cable.

Incremental encoder

Each incremental encoder must have a 0° output and a 90° output so that the direction of travel can be detected.

Requirements for incremental encoders:

- Dual-channel encoder with 90° phase separation
- Outputs: push-pull
- Shielded cable

- Max pulse rate: 100 kHz
- Minimum number of pulses: 100 pulses per cm

Suitable incremental encoders are available from SICK. Additional information can be obtained from your SICK subsidiary.

4.4.6 Universal inputs, universal outputs, universal I/Os

Universal I/O can be configured as universal input or as universal output. In addition, certain universal I/Os can be used in pairs as OSSD pairs, depending on the device.

Depending on the device, a universal input can be used for resetting, external device monitoring (EDM), sleep mode, or restarting the protective device, for example. If sleep mode is activated by a universal input, the sleep mode must not be used for safety applications. Certain universal inputs can also be used in pairs as a static control input.

The function of a universal output is configurable. Which functions are available depends on the device. Possible signals are, for example: reset required, contamination warning.

A universal output must not be used for safety functions.

Further topics

- ["Electrical installation", page 55](#)
- ["Technical data", page 121](#)

4.4.7 Restart interlock

Overview

Depending on the regulations which apply at the place of installation, a restart interlock may be required.

The restart interlock prevents the machine from automatically starting up, for example after a protective device has responded while the machine is operating or after changing the machine's operating mode.

First, the operator must press a reset pushbutton to return the protective device to monitoring status. Then, in a second step, the operator can restart the machine.

Prerequisites

- The control switch for resetting the restart interlock (reset button) is mounted outside the hazardous area.
- Persons within the hazardous area cannot operate the reset button.
- Any person operating the control switch can view the entire hazardous area.

Internal restart interlock

Each safety output of the safety laser scanner is equipped with a configurable internal restart interlock.

When the internal restart interlock is used, the following sequence is the result for the machine operator:

- 1 A safety output of the safety laser scanner switches to the OFF state, if there is an interruption in the protective field.
- 2 The safety output remains in the OFF state when there is no longer an object in the protective field.
- 3 The safety output only switches back to the ON state when the operator presses the reset pushbutton, which is outside the hazardous area. If there is an object in the protective field when the reset pushbutton is pressed, the safety output stays in the OFF state.
- 4 After the reset, the operator can restart the machine in a second step.

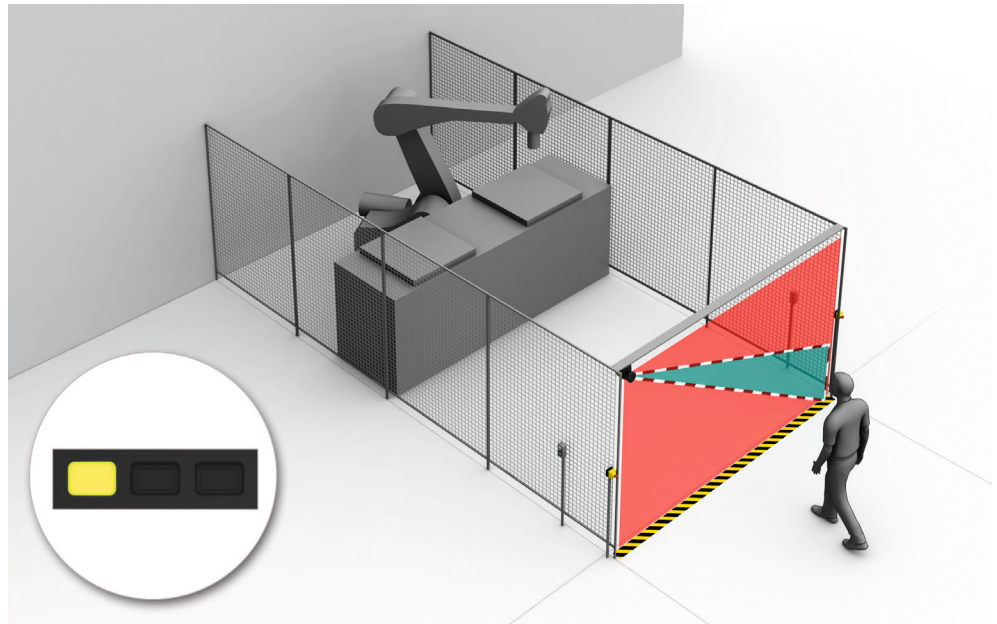

Figure 30: How the restart interlock works (1): no one in protective field, machine operates

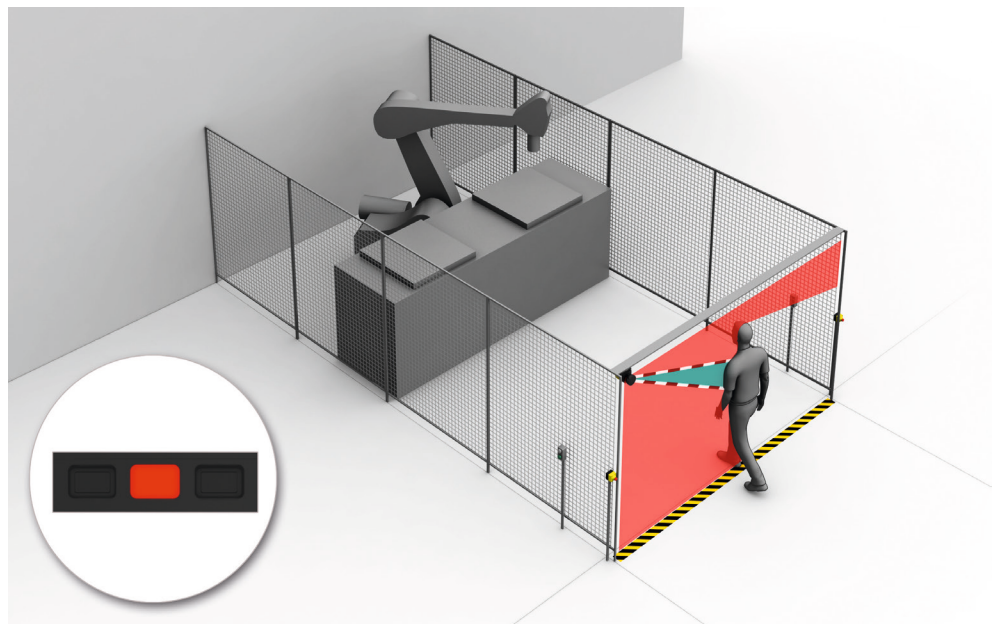

Figure 31: How the restart interlock works (2): person detected in protective field, safety output in OFF state

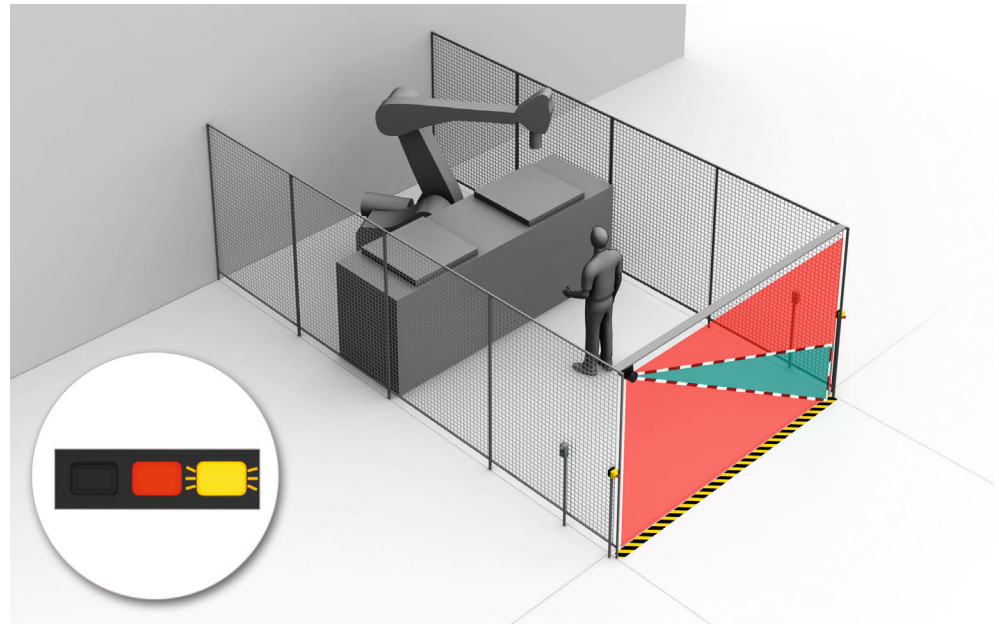

Figure 32: How the restart interlock works (3): person in hazardous area, no detection in protective field, safety output still in OFF state

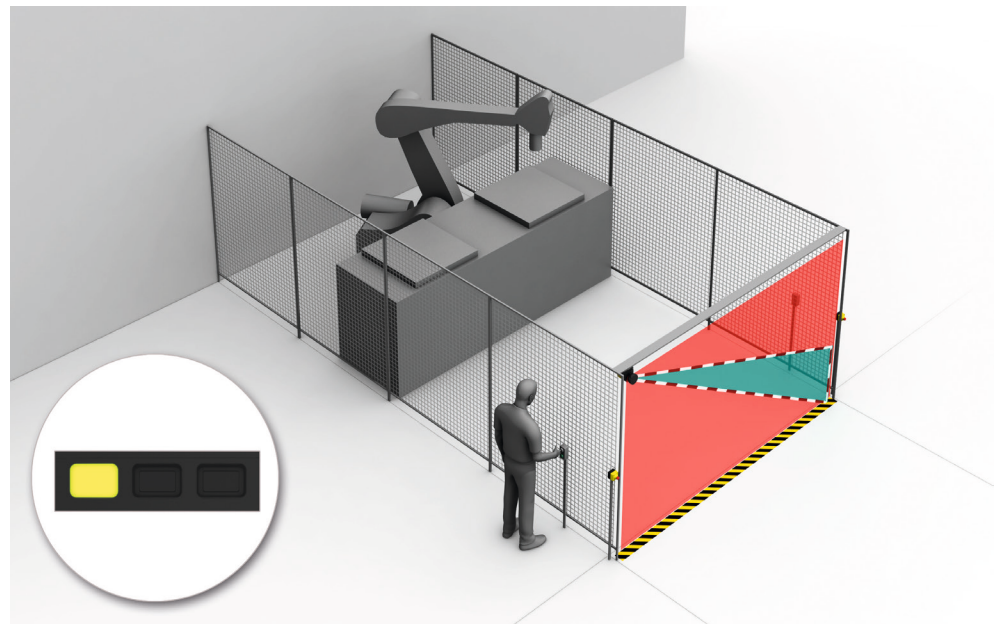

Figure 33: How the restart interlock works (4): the reset pushbutton must be pressed before restarting the machine.

4.4.8 External device monitoring (EDM)

Overview

The external switching elements (external device monitoring, EDM) must be inspected in line with the regulations which apply at the place of installation or the required reliability of the safety function.

The external device monitoring (EDM) monitors the status of downstream contactors.

Prerequisites

- Positively guided contactors are used for shutting down the machine. If the auxiliary contacts of the positively guided contactors are connected to the external device monitoring, the external device monitoring checks whether the contactors switch correctly when the OSSDs are switched off.

4.5 Integration into the network

4.5.1 Network services and ports

The network connection is available for certain system plugs.

Table 5: Network services and ports

| Use | Protocol | Source | Source port | Target | Destination port |
|--|----------|--|------------------------|---|------------------------|
| DHCP | UDP | nanoScan3 | 68 | DHCP server | 67 |
| | | DHCP server | 67 | nanoScan3 | 68 |
| SNTP | UDP | nanoScan3 | 123 | NTP server | 123 |
| | | NTP server | 123 | nanoScan3 | 123 |
| CoLa 2 (protocol from SICK, configuration and diagnostics) | TCP | CoLa 2 client, e.g., computer with Safety Designer | Selected by the client | nanoScan3 | 2122 |
| | | nanoScan3 | 2122 | CoLa 2 client, e.g., computer with Safety Designer | Selected by the client |
| CoLa 2 (protocol from SICK, device search) | UDP | Computer with Safety Designer | 30,718 ... 30,738 | nanoScan3 or Limited Broadcast or Directed Broadcast | 30718 |
| | | nanoScan3 | 30718 | Computer with Safety Designer (if in the same subnet) or Broadcast (if in a different subnet) | 30,718 ... 30,738 |
| Data output in transmit mode continuous | UDP | nanoScan3 | Randomly selected | Target computer | Configurable |

4.6 Testing plan

The manufacturer of the machine and the operating entity must define all required thorough checks. The definition must be based on the application conditions and the risk assessment and must be documented in a traceable manner.

The following tests must be planned:

- Before commissioning the machine and after making changes, you must check whether the safety functions are fulfilling their planned purpose and whether persons are being adequately protected.
- The thorough checks of the safety laser scanner must fulfill certain minimum requirements.

A test object is required for some thorough checks. An optically opaque cylinder with a black surface can be used as a suitable test object. The diameter must match the configured resolution.

4.6.1 Planning the thorough check during commissioning and in certain situations

Minimum requirements

The protective device and its application must be thoroughly checked in the following situations:

- Before commissioning
- After changes to the configuration or the safety function
- After changes to the mounting, the alignment, or the electrical connection
- After exceptional events, such as after manipulation has been detected, after modification of the machine, or after replacing components

The thorough check ensures the following:

- All relevant regulations are complied with and the protective device is active for all of the machine's operating modes. This includes the following points:
 - compliance with standards
 - correct use of the protective device
 - suitable configuration and safety function
 - correct alignment
- The documentation accurately reflects the state/condition of the machine, including the protective device.
- The verified configuration report matches the desired project planning (see ["Verify configuration", page 93](#)).

The thorough checks must be carried out by qualified safety personnel or specially qualified and authorized personnel, and must be documented in a traceable manner.

Recommended thorough checks

In many cases, it makes sense to carry out the following thorough checks during commissioning and in certain situations:

- Test of the relevant points on the checklist, see ["Checklist for initial commissioning and commissioning", page 143](#)
- ["Visual check of the machine and the protective device", page 52](#)
- ["Thorough check of the principal function of the protective device", page 50](#)
- ["Thorough check of the area to be protected", page 51](#)
- ["Test of the contour detection field", page 51](#)
- Instruction of the operators in the function of the protective device

4.6.2 Planning the regular thorough check

Overview

The purpose of regular tests is to detect defects due to changes or external influences (e.g. damage or manipulation) and to ensure that the protective measure provides the necessary protection.

Important information



WARNING

Hazard due to lack of effectiveness of the protective device

Persons and parts of the body to be protected may not be recognized in case of non-observance.

- ▶ Carry out tests at least once a year.
- ▶ Assign competent persons to carry out the tests or persons specifically authorized for this purpose.
- ▶ Document tests in a traceable manner.

Minimum requirements for the regular thorough check

The following thorough checks must be carried out at least once a year:

- ["Thorough check of the principal function of the protective device"](#), page 50
- Test of the detection capability (resolution), see ["Thorough check of the area to be protected"](#), page 51

Recommendations for further thorough checks

In many cases, depending on the application conditions, the risk assessment of the machine determines that further thorough checks are required or that some thorough checks must take place more frequently.

In many cases, it makes sense to carry out the following thorough checks together with the regular thorough check:

- ["Visual check of the machine and the protective device"](#), page 52
- ["Test of the contour detection field"](#), page 51
- Test of the relevant points on the checklist, see ["Checklist for initial commissioning and commissioning"](#), page 143

In many cases, it makes sense to carry out the following thorough checks daily:

- ["Visual check of the machine and the protective device"](#), page 52
- ["Thorough check of the principal function of the protective device"](#), page 50

Complementary information

If the thorough check reveals an error, the machine should be shut down immediately. In this case, the mounting and electrical installation of the device must be checked by appropriately qualified safety personnel.

4.6.3 Notes on the tests

Thorough check of the principal function of the protective device

Recommended approach:

- ▶ Observe display and status LEDs. An error has occurred if at least one LED does not light up permanently when the machine is switched on.
- ▶ Test the function of the protective device. To do this, trigger the protective function once and observe the safety output's reaction using the reaction of the machine, for example.
 - All applications: During the thorough check, observe whether the safety laser scanner displays the interruption of the protective field using the LEDs and/or the display.
 - Stationary application (hazardous area protection, access protection, hazardous point protection):
 - Interrupt the protective field with the intended test object and observe whether the machine stops.
 - Mobile application (mobile hazardous area protection):
 - Place the supplied test object in the path of the vehicle and observe whether the vehicle stops.
 - OR
 - Activate a protective field, which is interrupted by at least one test object and check the expected reaction (for example by an automatic test in the safety controller).

If the thorough check reveals an error, the machine should be shut down immediately. In this case, the mounting and electrical installation of the device must be checked by appropriately qualified safety personnel.

Thorough check of the area to be protected

The area to be protected and the detection capability are checked during this thorough check.

The thorough check covers the following points:

- Changes in the detection capability (thorough check of all configured fields)
- Modifications, tampering and damage to the protective device or the machine, which lead to changes in the area to be protected or the position of the protective field

Recommended approach for hazardous area protection:

- ▶ Position the supplied test object at a number of points at the edges of the area to be protected. The safety laser scanner must detect the test object at each position and indicate the detection. How it is indicated depends on the configuration. The number and position of sites where the thorough check is carried out must be chosen so that undetected access to the hazardous area is impossible.
- ▶ If a number of protective fields are used (in different monitoring cases for example), check the edges of all protective fields.

Recommended approach for access protection and hazardous point protection:

- ▶ Move the supplied test object along the edges of the area to be protected. The safety laser scanner must detect the test object at each position and indicate the detection. How it is indicated depends on the configuration. The protective field must be dimensioned such that reaching around or going around it is impossible.
- ▶ If a number of protective fields are used (in different monitoring cases for example), check the edges of all protective fields.
- ▶ If the reference contour monitoring feature is used, check the areas with the reference contour:
 - Move the test object along the inner edge of the tolerance band of the reference contour. The safety laser scanner must detect the test object at each position and indicate the detection.
 - If several reference contours are used, test all reference contours.

Recommended approach for mobile hazardous area protection:

- ▶ Place the supplied test object in the path of the vehicle and check whether the vehicle comes to a stop in time.
- ▶ If a number of protective fields are used (in different monitoring cases for example), check whether the vehicle comes to a stop in time in all of the protective fields.
- ▶ If necessary, change the position of the test object so that a thorough check is carried out for each monitoring case to determine whether the protective field is active over the whole of the required width.
- ▶ Check the height of the scan plane. The scan plane must be at a height of at least 200 mm so that people lying down can be reliably detected. For this purpose, position the supplied test object at a number of points at the edges of the largest protective field. The safety laser scanner must detect the test object at each position and indicate the detection. How it is indicated depends on the configuration.

If the thorough check reveals an error, the machine should be shut down immediately. In this case, the mounting and electrical installation of the device must be checked by appropriately qualified safety personnel.

Test of the contour detection field

If you use contour detection fields, you must test whether each contour detection field fulfills the intended function.

Notes on planning the test

- Which contour should be detected at which position? What is the desired result?
- What is the desired result if the contour is not at the position?
- What is the desired result if only one part of the contour is at the position?
- Is it possible for there to be another object at the intended position instead of the expected object, so that the device still recognizes the contour? What is the desired result?

If the thorough check reveals an error, the machine should be shut down immediately. In this case, the mounting and electrical installation of the device must be checked by appropriately qualified safety personnel.

Visual check of the machine and the protective device

Recommended approach:

- ▶ Check whether the machine or the protective device has been modified or manipulated so that the effectiveness of the protective device may be impaired.
- ▶ In particular, check the following points:
 - Has the machine been retrofitted?
 - Have machine parts been removed?
 - Have modifications been made to the surroundings of the machine?
 - Are there any defective cables or open cable ends?
 - Have the protective device or its parts been dismantled?
 - Is the protective device damaged?
 - Is the protective device severely contaminated?
 - Is the optical cover contaminated, scratched or destroyed?
 - Has the protective device's alignment been changed?
 - Are there any objects (e.g. cables, reflective surfaces) in the protective field?

If one of the points applies, the machine should be shut down immediately. In this case, the machine and the protective device must be checked by appropriately qualified safety personnel.

5 Mounting

5.1 Safety

Important information



DANGER

Death or severe injury due to electrical voltage and/or an unexpected startup of the machine

- ▶ Make sure that the machine is (and remains) disconnected from the voltage supply during mounting and electrical installation.
- ▶ Make sure that the dangerous state of the machine is and remains switched off.



NOTICE

The optics cover of the safety laser scanner is an optical component.

- ▶ Do not contaminate or scratch the optics cover during unpacking and mounting.
- ▶ Prevent fingerprints on the optics cover.

5.2 Unpacking

Procedure

- ▶ Check the components for completeness and the integrity of all parts.
- ▶ In the event of complaints, contact the responsible SICK subsidiary.

Further topics

- ["Ordering information", page 132](#)

5.3 Fitting the system plug

Prerequisites

Tool required:

- TX10 key

Procedure

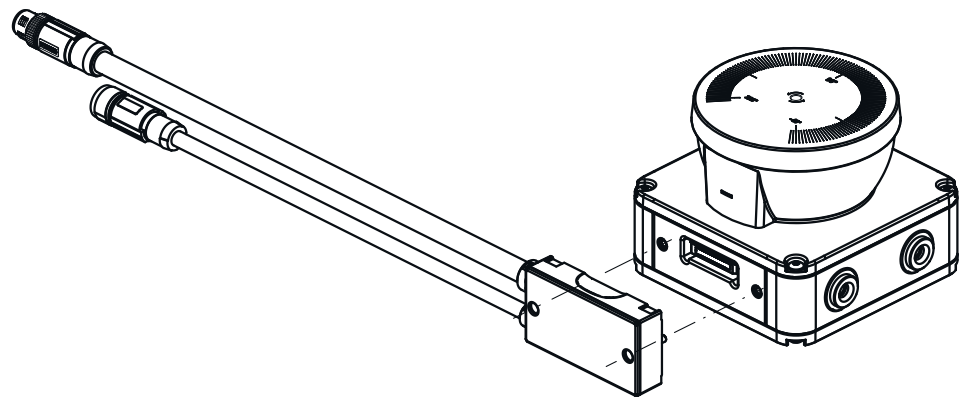

1. Carefully insert the system plug into the safety laser scanner.
2. Screw in the system plug using the captive screws. Tightening torque: 1.3 Nm.

5.4 Mounting the device

Prerequisites

- Project planning has been completed.
- Mount according to project planning.
- Installation location provides protection against moisture, dirt and damage.
- Status indicators are easily visible after mounting.

Procedure

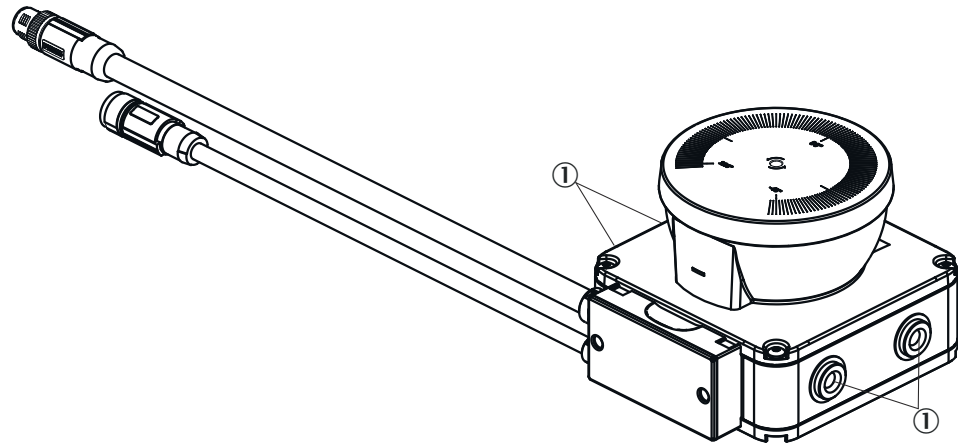

Figure 34: Mounting safety laser scanner

① Side M5 threaded hole

- ▶ Use all four sides of M5 threaded holes for direct mounting, so the values given in the data sheet for vibration and shock resistance are achieved.
- ▶ Maximum depth of thread engagement: 7.5 mm.
- ▶ Tightening torque: 4.5 Nm ... 5.0 Nm.
- ▶ In case of strong vibrations, use screw locking devices to secure the fixing screws.

Complementary information

To facilitate mounting and alignment, SICK offers mounting kits as accessories.

Further topics

- ["Project planning", page 20](#)
- ["Dimensional drawings", page 131](#)

6 Electrical installation

6.1 Safety

Important information



DANGER

Death or severe injury due to electrical voltage and/or an unexpected startup of the machine

- ▶ Make sure that the machine is (and remains) disconnected from the voltage supply during mounting and electrical installation.
- ▶ Make sure that the dangerous state of the machine is and remains switched off.

6.2 Connecting

Overview

Depending on the system plug used, the connection is made via M12 plug connectors or flying leads.

Prerequisites

- Project planning has been completed.
- Mounting is complete.
- Electrical installation according to project planning.
- Electrical installation according to the requirements of [section 4.4, "Integration in the electrical control system", page 40](#).
- Functional earth is connected correctly.

Further topics

- ["Project planning", page 20](#)
- ["Mounting", page 53](#)

6.2.1 Connecting cable with M12 plug connector, 8-pin

Voltage supply and local inputs and outputs

- Male connector
- M12
- 8-pin
- A-coded

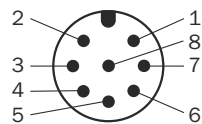

Figure 35: Connecting cable (male connector, M12, 8-pin, A-coded)

Table 6: Pin assignment of the connecting cable with 8-pin M12 plug connector

| Pin | Designation | Function |
|--------|-------------|--|
| 1 | 24 V DC | Supply voltage (+24 V DC) |
| 2 | OSSD 1.A | OSSD pair 1, OSSD A |
| 3 | 0 V DC | Supply voltage (0 V DC) |
| 4 | OSSD 1.B | OSSD pair 1, OSSD B |
| 5 | Uni-I/O 01 | Universal I/O 1, configurable: <ul style="list-style-type: none"> • Universal input: resetting, EDM (external device monitoring), standby, restarting the device • Universal output: contamination, error, reset required, monitoring result |
| 6 | Uni-I/O 02 | Universal I/O 2, configurable: <ul style="list-style-type: none"> • Static control input A1 (together with pin 7) • Universal input: resetting, EDM (external device monitoring), standby, restarting the device • Universal output: contamination, error, reset required, monitoring result |
| 7 | Uni-I/O 03 | Universal I/O 3, configurable: <ul style="list-style-type: none"> • Static control input A2 (together with pin 6) • Universal input: resetting, EDM (external device monitoring), standby, restarting the device • Universal output: contamination, error, reset required, monitoring result |
| 8 | FE | Functional earth/shield |
| Thread | FE | Functional earth/shield |

6.2.2 Connecting cable with M12 plug connector, 17-pin

Voltage supply and local inputs and outputs

- Male connector
- M12
- 17-pin
- A-coded

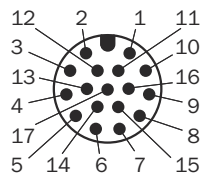

Figure 36: Connecting cable (male connector, M12, 17-pin, A-coded)

Table 7: Pin assignment of the connecting cable with 17-pin M12 plug connector

| Pin | Designation | Function |
|-----|-------------|--|
| 1 | 24 V DC | Supply voltage (+24 V DC) |
| 2 | 0 V DC | Supply voltage (0 V DC) |
| 3 | OSSD 1.A | OSSD pair 1, OSSD A |
| 4 | OSSD 1.B | OSSD pair 1, OSSD B |
| 5 | Uni-I/O 01 | Universal I/O 1, configurable: <ul style="list-style-type: none"> • Static control input B1 • Universal input: sleep mode, restarting the device • Universal output: contamination, error, reset required (OSSD pair 1), monitoring result |

| Pin | Designation | Function |
|--------|-------------|--|
| 6 | Uni-I/O 02 | Universal I/O 2, configurable: <ul style="list-style-type: none"> • OSSD pair 2, OSSD A (OSSD 2.A) • Static control input A1 • Universal input: sleep mode, restarting the device • Universal output: contamination, error, monitoring result |
| 7 | Uni-I/O 03 | Universal I/O 3, configurable: <ul style="list-style-type: none"> • OSSD pair 2, OSSD B (OSSD 2.B) • Static control input A2 • Universal input: sleep mode, restarting the device • Universal output: contamination, error, monitoring result |
| 8 | Uni-I/O 04 | Universal I/O 4, configurable: <ul style="list-style-type: none"> • Static control input B2 • Universal input: sleep mode, restarting the device • Universal output: contamination, error, reset required (OSSD pair 2), monitoring result |
| 9 | Uni-I 01 | Universal input 1, configurable: <ul style="list-style-type: none"> • Static control input C1 • Dynamic control input 1a (0°) • Universal input: sleep mode, restarting the device |
| 10 | Uni-I 02 | Universal input 2, configurable: <ul style="list-style-type: none"> • Static control input C2 • Dynamic control input 1b (90°) • Universal input: sleep mode, restarting the device |
| 11 | Uni-I 03 | Universal input 3, configurable: <ul style="list-style-type: none"> • Static control input D1 • Dynamic control input 2a (0°) • Universal input: sleep mode, restarting the device |
| 12 | Uni-I 04 | Universal input 4, configurable: <ul style="list-style-type: none"> • Static control input D2 • Dynamic control input 2b (90°) • Universal input: sleep mode, restarting the device |
| 13 | Uni-I 05 | Universal input 5, configurable: <ul style="list-style-type: none"> • Static control input E1 • Universal input: resetting, (OSSD pair 1), sleep mode, restarting the device |
| 14 | Uni-I 06 | Universal input 6, configurable: <ul style="list-style-type: none"> • Static control input E2 • Universal input: EDM (external device monitoring, OSSD pair 1), sleep mode, restarting the device |
| 15 | Uni-I 07 | Universal input 7, configurable: <ul style="list-style-type: none"> • Static control input F1 • Universal input: resetting, (OSSD pair 2), sleep mode, restarting the device |
| 16 | Uni-I 08 | Universal input 8, configurable: <ul style="list-style-type: none"> • Static control input F2 • Universal input: EDM (external device monitoring, OSSD pair 2), sleep mode, restarting the device |
| 17 | nc | Not connected |
| Thread | FE | Functional earth/shield |

6.2.3 Connecting cable with flying leads, 17-wire

Voltage supply and local inputs and outputs

- Flying leads
- 17-wire



Table 8: Pin assignment of the connecting cable with flying leads, 17-wire

| Wire color | Designation | Function |
|------------|-------------|--|
| Brown | 24 V DC | Supply voltage (+24 V DC) |
| Blue | 0 V DC | Supply voltage (0 V DC) |
| White | OSSD 1.A | OSSD pair 1, OSSD A |
| Green | OSSD 1.B | OSSD pair 1, OSSD B |
| Pink | Uni-I/O 01 | Universal I/O 1, configurable: <ul style="list-style-type: none"> • Static control input B1 • Universal input: sleep mode, restarting the device • Universal output: contamination, error, reset required (OSSD pair 1), monitoring result |
| Yellow | Uni-I/O 02 | Universal I/O 2, configurable: <ul style="list-style-type: none"> • OSSD pair 2, OSSD A (OSSD 2.A) • Static control input A1 • Universal input: sleep mode, restarting the device • Universal output: contamination, error, monitoring result |
| Black | Uni-I/O 03 | Universal I/O 3, configurable: <ul style="list-style-type: none"> • OSSD pair 2, OSSD B (OSSD 2.B) • Static control input A2 • Universal input: sleep mode, restarting the device • Universal output: contamination, error, monitoring result |
| Gray | Uni-I/O 04 | Universal I/O 4, configurable: <ul style="list-style-type: none"> • Static control input B2 • Universal input: sleep mode, restarting the device • Universal output: contamination, error, reset required (OSSD pair 2), monitoring result |
| Red | Uni-I 01 | Universal input 1, configurable: <ul style="list-style-type: none"> • Static control input C1 • Dynamic control input 1a (0°) • Universal input: sleep mode, restarting the device |
| Violet | Uni-I 02 | Universal input 2, configurable: <ul style="list-style-type: none"> • Static control input C2 • Dynamic control input 1b (90°) • Universal input: sleep mode, restarting the device |
| Grey/Pink | Uni-I 03 | Universal input 3, configurable: <ul style="list-style-type: none"> • Static control input D1 • Dynamic control input 2a (0°) • Universal input: sleep mode, restarting the device |
| Red/Blue | Uni-I 04 | Universal input 4, configurable: <ul style="list-style-type: none"> • Static control input D2 • Dynamic control input 2b (90°) • Universal input: sleep mode, restarting the device |

| Wire color | Designation | Function |
|---------------|-------------|---|
| White/Green | Uni-I 05 | Universal input 5, configurable: <ul style="list-style-type: none"> • Static control input E1 • Universal input: resetting, (OSSD pair 1), sleep mode, restarting the device |
| Brown/Green | Uni-I 06 | Universal input 6, configurable: <ul style="list-style-type: none"> • Static control input E2 • Universal input: EDM (external device monitoring, OSSD pair 1), sleep mode, restarting the device |
| White/yellow | Uni-I 07 | Universal input 7, configurable: <ul style="list-style-type: none"> • Static control input F1 • Universal input: resetting, (OSSD pair 2), sleep mode, restarting the device |
| Yellow/Brown | Uni-I 08 | Universal input 8, configurable: <ul style="list-style-type: none"> • Static control input F2 • Universal input: EDM (external device monitoring, OSSD pair 2), sleep mode, restarting the device |
| White/Gray | nc | Not connected |
| - (shielding) | FE | Functional earth |

6.2.4 Network connection

Network connection

- Female connector
- M12
- 4-pin
- D-coded
- Pin assignment according to IEC 61918, Appendix H

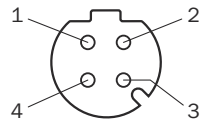

Figure 37: Network pin assignment (M12 female connector, 4-pin, D-coding)

Table 9: Network pin assignment

| Pin | Designation | Function |
|--------|-------------|----------------|
| 1 | TX+ | Send data + |
| 2 | RX+ | Receive data + |
| 3 | TX- | Send data - |
| 4 | RX- | Receive data - |
| Thread | SH | Shielding |

7 Configuration

7.1 Delivery state

The device is not configured in the delivery state.

7.2 Safety Designer configuration software

The safety laser scanner is configured using the Safety Designer.

For information on the Safety Designer, see the operating instructions for the Safety Designer item no. 8018178.

7.2.1 Installing Safety Designer

Prerequisites

- Your Windows user account has rights for installing software.

Procedure

1. Call up the download web page and enter **Safety Designer** in the search field on www.sick.com.
2. Take note of the system requirements on the download page.
3. Download the installation file from the download page. Extract it and run it.
4. Follow the notes from the setup assistant.

Complementary information

The SQL CE database is required to open legacy projects with the **.sdp** ending. When installing Safety Designer, you can select whether SQL CE should be installed for compatibility of legacy projects.



NOTICE

The SQL CE database is not a trustworthy source. The installation of untrustworthy sources may pose a safety risk.

- ▶ Only install SQL CE if you have to convert legacy projects.
-

7.2.2 Projects

Using Safety Designer, you can configure one or more devices in a project. You can save the configuration data in a project file on the computer.

Creating a project

- ▶ Click on **Create new project**.
- ✓ This creates and opens an empty project.

Configuring a device online (device connected to computer)

The following interfaces are suitable for configuration:

- USB ²⁾
- Ethernet

If a device is connected to the computer, Safety Designer can establish a connection to the device. ³⁾

²⁾ The USB connection may only be used temporarily and only for configuration and diagnostics.

³⁾ If the device is only connected via the network and has no network address, Safety Designer can find the device but cannot establish a connection to it. You first need to assign the device a valid network address.

You will then configure the device online. In this case, you can transfer the configuration to the devices directly and use diagnostic functions.

- ▶ Click on **Connect**.
- ✓ Safety Designer searches for connected devices, with which it can establish a connection.

Configuring a device offline (device not connected to computer)

If the device is not connected to the computer, select it from the device catalog.

You will then configure the device offline. Diagnostics functions are not available.

You can connect the computer to the device later, assign a device to the device tile, and transfer the configuration to the device.

7.2.2.1 Saving verified configuration

When you save a project, information is saved for each device as to whether the configuration is verified. When you open a project file, each device tile and the **Overview** dialog box of the device window show whether the configuration is verified.

You can transfer a verified configuration to the same or an identical device again.

7.2.3 User interface

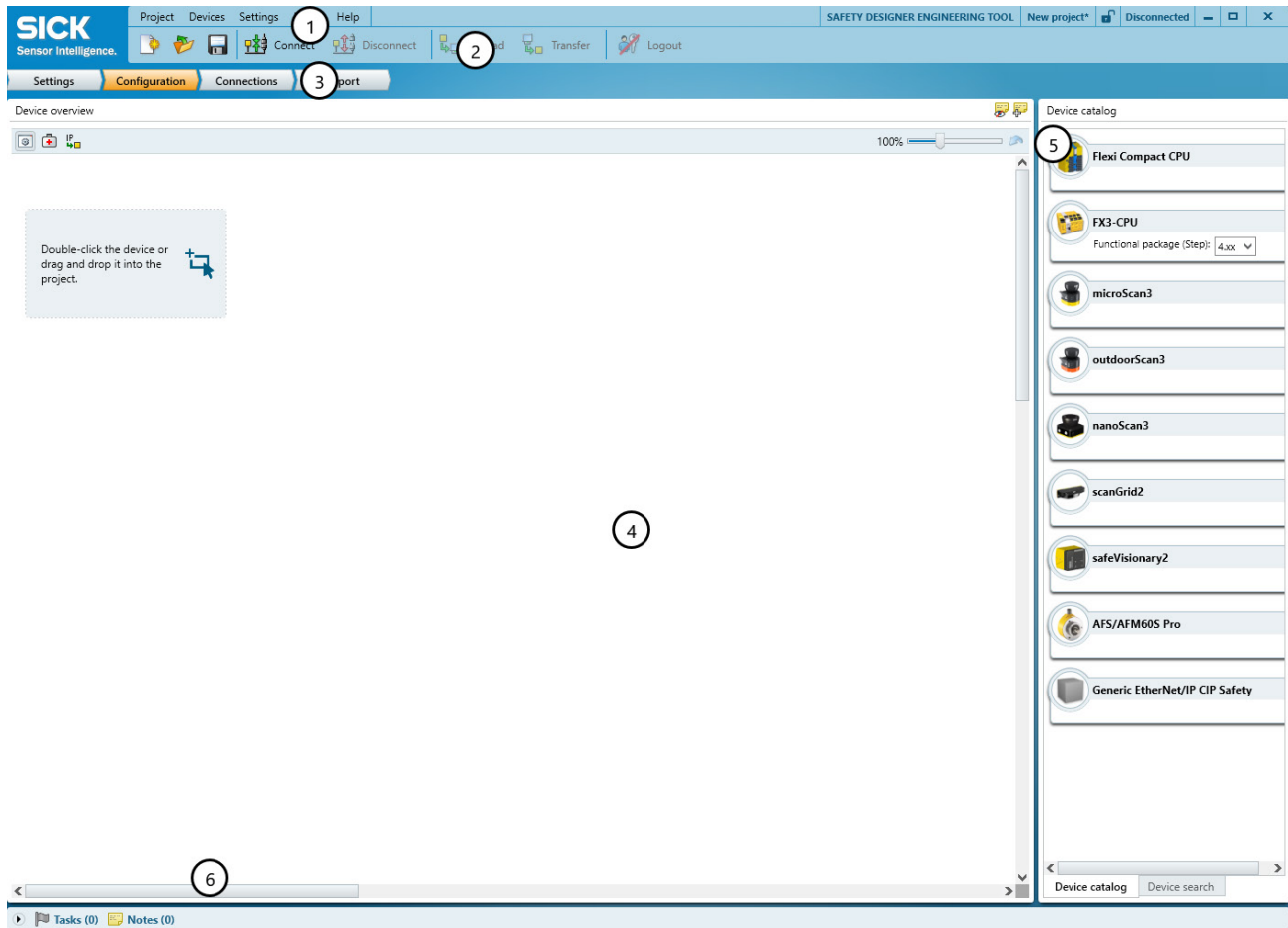

Figure 38: Software controls

- ① Menu bar
- ② Toolbar
- ③ Main navigation
- ④ Working range
- ⑤ Device catalog
- ⑥ Task list and notes

7.2.4 User groups

Overview

The devices contain a hierarchy of user groups that regulate access to the devices.

For certain actions (e.g., transferring a configuration to the device), you are requested to log onto the device with the respective user group.

Important information



NOTICE

When you log into a device, the configuration software stores the password so that you do not need to re-enter it for other configuration steps.





If you do not change any other settings in the login dialog, the password is deleted as soon as you exit the configuration software, or log out in the main window or Device window.

If you enable the **Temporarily store password for login on additional devices.** function, the password will be retained even if you log out in the device window only.

If you leave the computer unattended, you must log off to prevent unwanted access to the device.

User groups

Table 10: User groups

| User group | Password | Authorization |
|---|--|--|
|  Operator | No password required. Anyone can log on as a machine operator. | <ul style="list-style-type: none"> • May read configuration from the device. |
|  Maintenance personnel | Deactivated ex-works, i.e. it is not initially possible to log on as a maintenance technician. The user group can be activated by the user group administrator and provided with a password. | <ul style="list-style-type: none"> • May read configuration from the device. • May transmit verified configuration to the device. • Change own password allowed. |
|  Authorized client | Deactivated ex-works, i.e. it is not initially possible to log on as an authorized customer. The user group can be activated by the user group administrator and provided with a password. | <ul style="list-style-type: none"> • May read configuration from the device. • May transmit verified and unverified configuration to the device. • May verify configuration. • Resetting the safety function and communication settings to factory defaults is allowed. • Change own password allowed. • Changing the password of the Maintenance personnel user group is allowed. |
|  Administrator | <p>The password SICKSAFE is created at the factory.</p> <ul style="list-style-type: none"> ▶ Change this password to protect the device against unauthorized access. | <ul style="list-style-type: none"> • May read configuration from the device. • May transmit verified and unverified configuration to the device. • May verify configuration. • Resetting whole device to factory settings allowed. • Activating and deactivating device functions is allowed. • Activating and deactivating the Maintenance personnel and Authorized client user groups is allowed. • Change own password allowed. • Changing the passwords of the Maintenance personnel and Authorized client user groups is allowed. |

Complementary information

The configuration of the device is saved in the system plug. Therefore, the passwords are retained when the device is replaced if the system plug is still used.

7.2.5 Settings

Information on the functionality and basic operation of the software and on the settings in the main window can be found in the operating instructions of the Safety Designer (part number 8018178).

7.2.6 Configuration

You collect the devices of a project in the **Configuration** area. The available devices can be found in the Device Catalog. The devices are displayed as Device tiles in the working range.

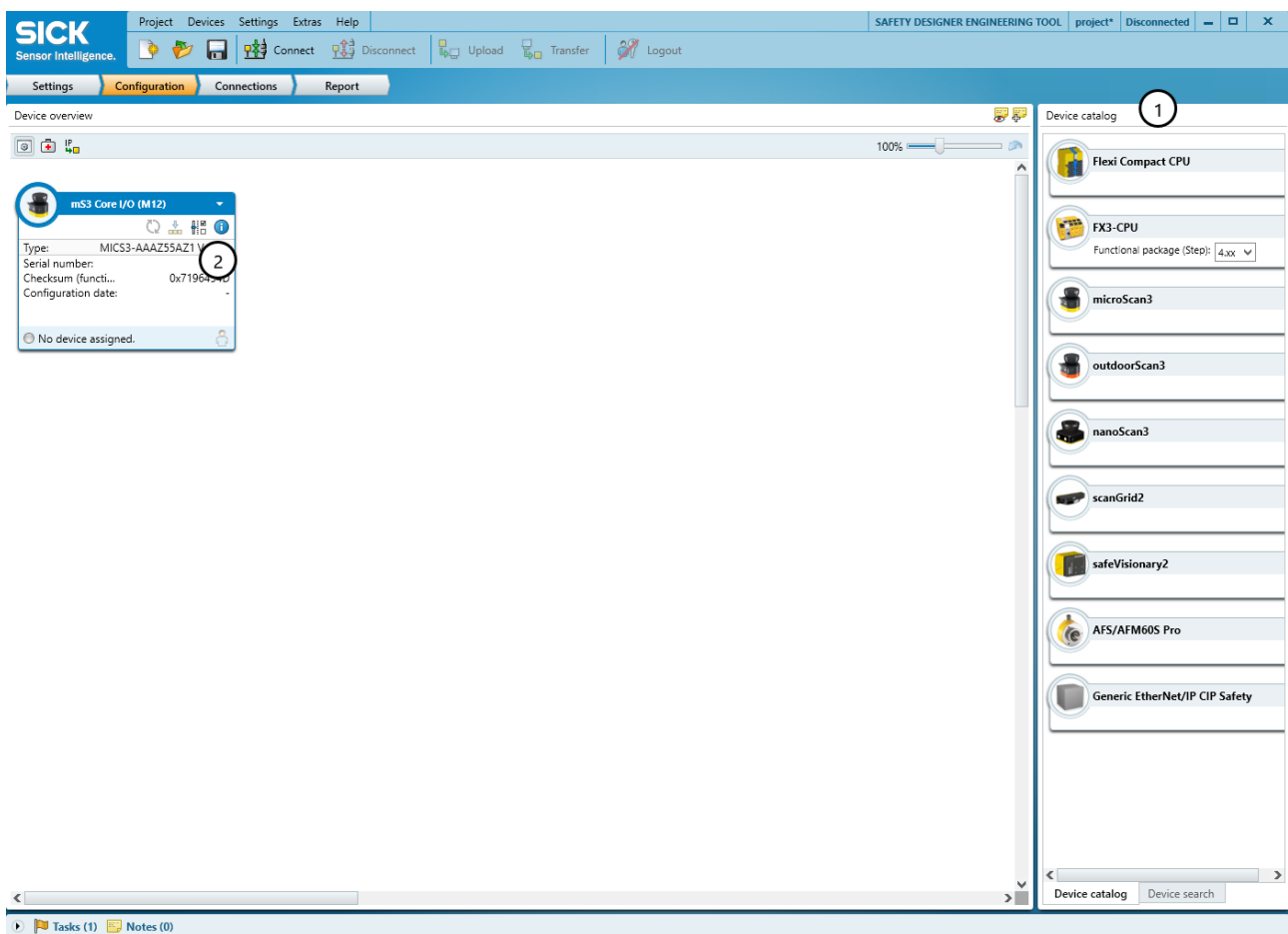

Figure 39: Configuration

- ① Device Catalog
- ② Device tile

7.2.6.1 Device Catalog

Overview

The device catalog contains all available devices:

- The **Device catalog** tab contains the devices installed in Safety Designer.
- The **Device search** tab contains the devices found during a device search.

Procedure

The devices from the device catalog can be added to a project in the workspace:

- ▶ Drag a device into the working area using drag and drop.
- Or:
- ▶ Double-click on a device in the device catalog.
- ✓ The device is shown as a tile in the working area.

Complementary information

When a device is configured offline for the first time, the device selection wizard opens for devices with multiple variants (device types). This is where you select the exact type of device to be configured.

7.2.6.2 Open the device window – configure devices

Overview

To configure the device, perform diagnostics or create reports, open a device window.

Procedure

You have the following options:

- ▶ Double-click on the Device tile.
- Or:
- ▶ Open the tile menu and choose **Configure**.
- ✓ The device window opens.

Complementary information

When a device is configured offline for the first time, the device selection wizard opens for devices with multiple variants (device types). This is where you select the exact type of device to be configured.

7.2.6.3 Type code in Safety Designer

The Safety Designer displays a separate type code for the device with system plug, which differs from the type code for the device without system plug.

Table 11: Type code in Safety Designer

| Device | | System plug | | Device with system plug |
|---------------------|-----------------|--|-----------------|-------------------------|
| Performance package | Type code | Connections | Type code | Type code |
| Core I/O | NANS3-AAAZ30AN1 | <ul style="list-style-type: none"> • Cable with plug connector | NANSX-AAABZZZ1 | NANS3-AAAZ30AN1P01 |
| | | <ul style="list-style-type: none"> • Cable with plug connector • Cable with M12 network connection | NANSX-AAABAEZZ1 | NANS3-AAAZ30AN1P02 |

| Device | | System plug | | Device with system plug |
|---------------------|-----------------|--|--------------------|-------------------------|
| Performance package | Type code | Connections | Type code | Type code |
| Pro I/O | NANS3-CAAZ30AN1 | <ul style="list-style-type: none"> Cable with plug connector | NANSX-AAACZZZ1 | NANS3-CAAZ30AN1P01 |
| | | <ul style="list-style-type: none"> Cable with plug connector Cable with M12 network connection | NANSX-AAACAEZZ1 | NANS3-CAAZ30AN1P02 |
| | | <ul style="list-style-type: none"> Flying leads (880 mm) | NANSX-AACCZZZ1S01 | NANS3-CAAZ30AN1P03 |
| | | <ul style="list-style-type: none"> Flying leads (2 m) | NANSX-AACCZZZ1 | |
| | | <ul style="list-style-type: none"> Flying leads (880 mm) Cable with M12 network connection | NANSX-AACCAEZZ1S01 | NANS3-CAAZ30AN1P04 |
| | | <ul style="list-style-type: none"> Flying leads (2 m) Cable with M12 network connection | NANSX-AACCAEZZ1 | |

7.3 Overview

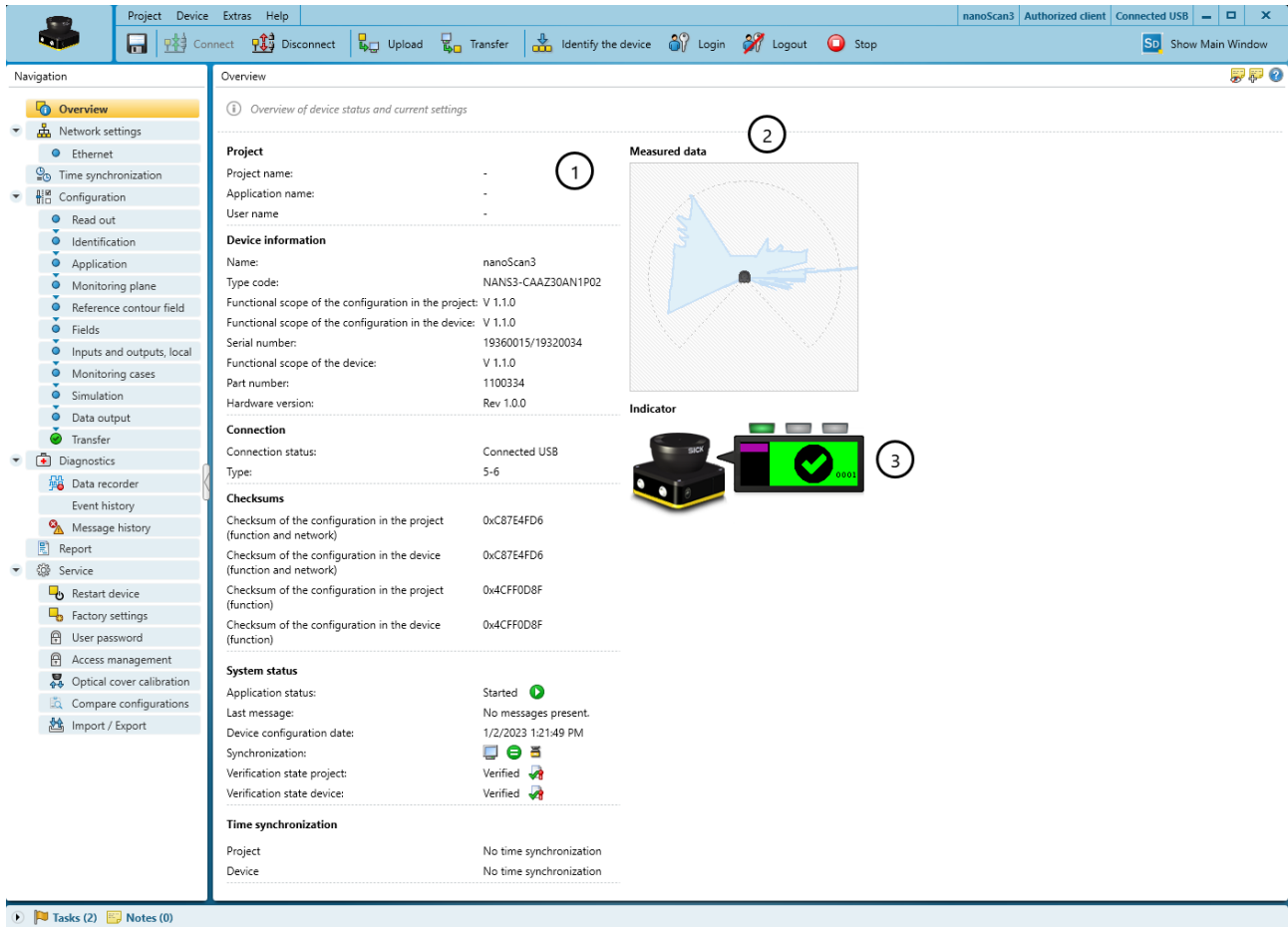

Figure 40: Overview

- ① Device information
- ② Current measurement data
- ③ Display with device status

The **Overview** dialog box contains information about the safety laser scanner.

Project

- **Project name:**
This name should be chosen the same for all devices in the project.
- **Application name:**
This name can be the same for a number of devices in the project. It highlights that these devices realize an application together, by responding to one another for example.
- **User name**

Device information

- **Name:**
Name for identification of the individual device.
- **Type code:**
- **Functional scope of the configuration in the project:**
- **Functional scope of the configuration in the device:**
- **Serial number:**
- **Functional scope of the device:**
- **Part number:**
- **Hardware version:**

Connection

- **Connection status:**
- **Type:**

Checksums

A checksum is used as a unique identification for a configuration. Using the checksum, it is possible to work out whether a setup was changed or whether two devices have the same configuration.

The checksum of the configuration in the project may not match the checksum in the device, for example if a field `geometry` has been modified, but not yet transmitted to the device.

System status

- **Application status:**
- **Last message:**
- **Device configuration date:**
- **Synchronization:**
Shows whether the configuration in Safety Designer and the configuration in the device are identical.
- **Verification state project:**
- **Verification state device:**

Time synchronization

- Configured value in the project
- Configured values in the device

Measured data

Shows the measurement data when a device is connected.

Indicator

Shows the status of the display and LEDs when a device is connected.

Establishing connection

If the safety laser scanner is correctly connected, you can establish the connection to the safety laser scanner by clicking **Connect**.

7.4 Network settings

7.4.1 Ethernet

IP address:

If you want to address the device via TCP/IP or output data, make the IP settings here.

Reading and transmitting values

If the values in the project and the values in the device differ, you can read the values out from the device and adopt them in the project. Alternatively, you can transmit values from the project to the device.

7.5 Time synchronization

Time synchronization

You can synchronize the time and date of the devices in the network. This is important, amongst other things, for ensuring that diagnostics and reports have synchronized and correct time stamps.

You can configure the time synchronization in the main window of the Safety Designer or in the device window.

Information on the functionality and basic operation of the software and on the settings in the main window can be found in the operating instructions of the Safety Designer (part number 8018178).

7.6 Reading configuration

Overview

At the left, you see the values configured in the project for the device. If the device is connected, you see the values saved in the device at the right.

If the values in the project and the values in the device differ, you can read the values out from the device and adopt them in the project.

Procedure

1. Click on **Read from device**.
✓ The values are read from the device and adopted in the project.

Complementary information

Configuration:

- **Name**
If a number of devices are used in an application or in a project, a unique device name helps to tell the individual devices apart.
- **Checksums**
A checksum is used as a unique identification for a configuration. Using the checksum, it is possible to work out whether a setup was changed or whether two devices have the same configuration.
The checksum of the configuration in the project may not match the checksum in the device, for example if a field geometry has been modified, but not yet transmitted to the device.

7.7 Identification

Overview

On the **Identification** page, you can optionally enter attributes for the device. The attributes are used to identify the device or to distinguish between different devices. The attributes appear in reports and in the diagnostic data.

Device name

If a number of devices are used in an application or in a project, a unique device name helps to tell the individual devices apart.

Project name

The project name is used to identify an entire project. The same project name should be chosen for all devices in the project.

Application name

The application name can be the same for a number of devices in the project.

User name

The optional user name helps later users to find a contact for the application.

Application image

An image helps to identify the application more quickly. The application image is saved in the project file on the computer and transmitted to the device. The Safety Designer supports the following file formats: BMP, GIF, JPG, PNG, TIF.

Description

A description makes it easier to understand an application's context more quickly.

7.8 Application

Application type

The type of application depends on the application of the safety laser scanner:

- **Mobile**
Mobile hazardous area protection is suitable for AGVs (automated guided vehicles), cranes, and forklifts to protect people when vehicles are moving or docking. The safety laser scanner monitors the area in the direction of travel and stops the vehicle as soon as an object is located in the protective field.
- **Stationary**
The position of the safety laser scanner is fixed. The safety laser scanner is mounted horizontally (for hazardous area protection) or vertically (for hazardous point protection and access protection).

Display language

The display of the safety laser scanner outputs notifications and states. Multiple languages are available for the display.

Display alignment

If you mount the safety laser scanner with the optics cover downward, you can rotate the orientation of the display through 180°. The preview shows the selected orientation of the display.

7.9 Monitoring plane

Overview

Here you configure general parameters for the monitoring level.

At first, the object resolution and multiple sampling configured for the monitoring plane apply for all fields. If necessary, you can make changes to each individually at a later date.

Resulting values are displayed in the area on the right. A graphic shows how the configuration affects the available ranges.

Name

You can use the name to identify monitoring planes when creating fields and monitoring cases and also in reports.

Safety task

People approach the monitoring plane parallel or orthogonally, depending on the orientation of the protective field in your application.

- **Hazardous area protection (Horizontal)**
Typically, for a horizontal approach, the requirement is to detect the leg. The typical object resolution is leg (70 mm).
- **Access protection (Vertical)**
Typically, for access protection, the requirement is to detect a person. The typical object resolution is body (200 mm).
- **Hazardous point protection (Vertical)**
Typically, for hazardous point protection, the requirement is to detect a hand. The typical object resolution is hand (40 mm).

Reference contour monitoring

If the monitoring plane has a vertical alignment, a contour (such as the floor, a part of the machine bed, or an access threshold) must typically be defined and monitored as a reference contour. The reference contour field is used for this purpose.

If reference contour monitoring is activated, the **Reference contour field** point is displayed in the navigation. Here you can configure the reference contour field required for your application.

Object resolution

The object resolution defines the size that an object must be to allow it to be reliably detected. The following object resolutions are available:

- 20 mm = hand detection
- 30 mm = hand detection
- 40 mm = hand detection
- 50 mm = leg detection/arm detection
- 60 mm = leg detection/arm detection
- 70 mm = leg detection/arm detection
- 150 mm = body detection
- 200 mm = body detection

Multiple sampling

Multiple sampling indicates how often an object has to be scanned before the safety laser scanner responds. A higher multiple sampling reduces the possibility that insects, weld sparks or other particles will cause the machine to be shut down. You will increase the machine's availability.

A multiple sampling of 2 is the minimum setting.

A higher multiple sampling increases the response time and influences the minimum distance.

Table 12: Recommended multiple sampling

| Application | Recommended multiple sampling |
|---|-------------------------------|
| Stationary application: such as horizontal hazardous area protection or vertical hazardous point protection under clean ambient conditions | 2x |
| Stationary application: such as vertical access protection Only 2-time or 3-time multiple sampling may be used for vertical access protection. | 2x |
| Mobile application | 4x |
| Stationary application: such as horizontal hazardous area protection under dusty ambient conditions | 8x |

Multiple sampling after monitoring case switching

When switching between monitoring cases, it is possible that a person may already be in the newly activated protective field when switching takes place. In order to ensure that the person is detected quickly and the dangerous state is brought to an end swiftly, you can adjust the settings for multiple sampling immediately after switching between monitoring cases – regardless of any other multiple sampling in place.

For persons and body parts to be reliably detected, each monitoring case must be active for at least as long as the safety laser scanner requires for detection (set multiple sampling after switching between monitoring cases multiplied by the scan cycle time).

- Fast (1 scan) (preset)**
Multiple sampling after switching between monitoring cases $n_{CS} = 1$. An object needs to be scanned once before the safety laser scanner responds. Fastest response and safest behavior of the safety laser scanner.
- Robust (multiple sampling - 1)**
Multiple sampling after switching between monitoring cases $n_{CS} = n - 1$. Multiple sampling after switching between monitoring cases is one scan fewer than any other multiple sampling in place. This reduces the possibility that insects, weld sparks, or other particles cause the machine to be switched off. This increases machine availability. The standard response time applies from the outset in the new field.
- User-defined (please consult manual)**
You can adjust the settings for multiple sampling after switching between monitoring cases in line with your requirements for the response time and reliability. Regardless of the exact settings here, multiple sampling after switching between monitoring cases is always at least one scan fewer than any other multiple sampling in place: $n_{CS} \leq n - 1$

Multiple sampling after object detection

The set multiple sampling also applies by default if a field becomes free again after an object detection. That means, when the field is free again, the free field is scanned the same number of times until the safety outputs switch back to the ON state.

If you activate the **Activate different multiple sampling rate after object detection** option, you can specify deviating values for the monitoring level or for individual fields. This may cause the outputs to switch back to the ON state faster or slower after a field has become free again.

The following case is only relevant if multiple sampling or different multiple sampling rate after object detection is set to a value $n < 6$: Regardless of whether a different multiple sampling rate after object detection is set, the multiple sampling after object detection will in some circumstances be increased to a value up to $n = 6$. This case arises if an object detection lasts for a longer period, i.e. if it takes a long time until the field is clear again.

7.10 Contour as Reference field

Overview

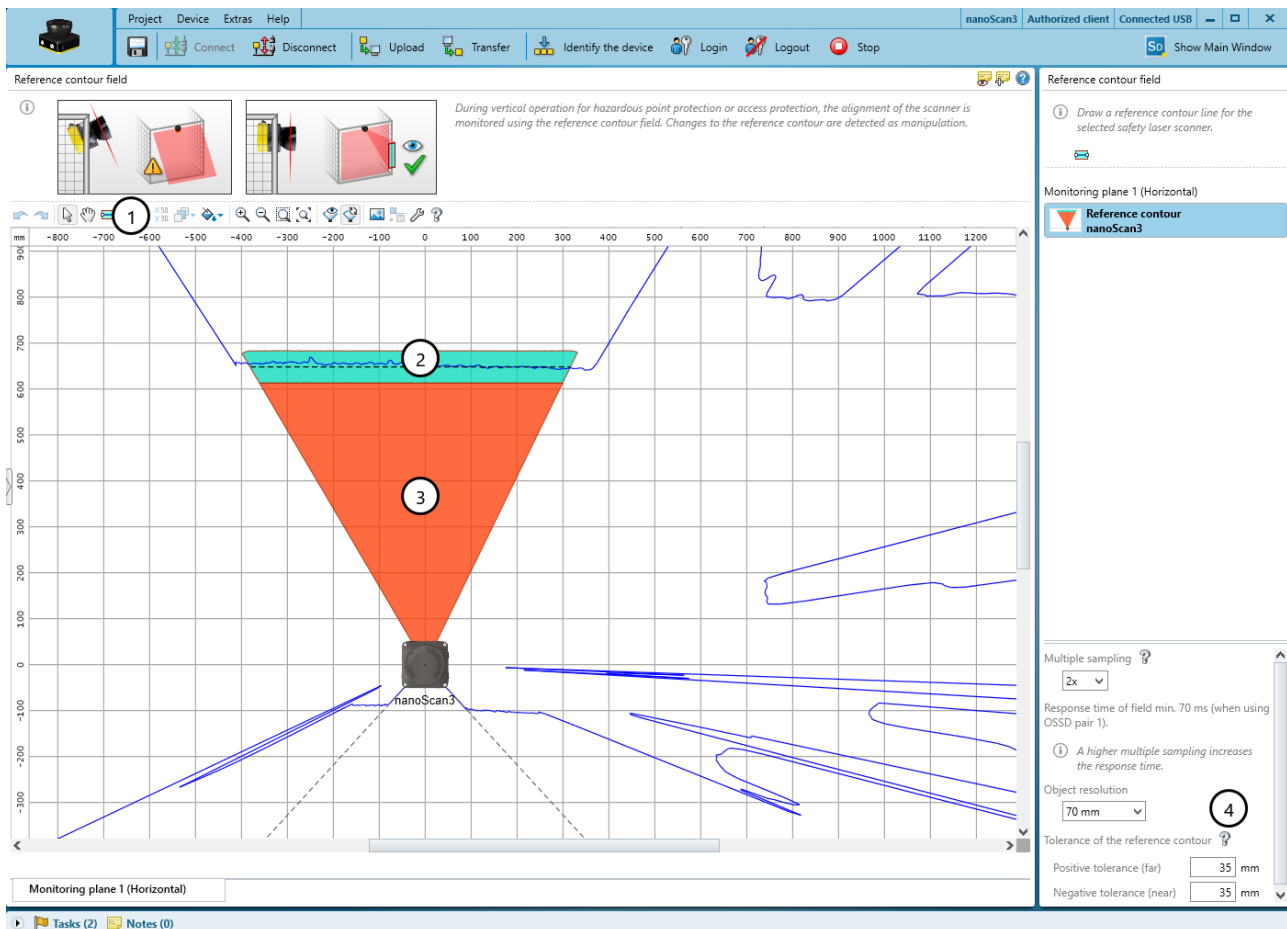

Figure 41: Contour as Reference field

- ① Tool for drawing reference contour fields
- ② Drawn contour with tolerance band
- ③ Contour as Reference field
- ④ Configure the field

If you have activated the **Reference contour monitoring** option for a monitoring plane, the **Reference contour field** dialog box is displayed.

The contour as reference field monitors a contour of the environment. The safety laser scanner switches all safety outputs to the OFF state if a contour does not match the set parameters, because, for example, the mounting of the safety laser scanner has been changed.

Drawing a reference contour field

1. Select the tool for drawing reference contour fields.
 2. First, use the mouse to click the desired contour.
 3. Click to add the corners of the contour.
 4. Finally, double-click the contour.
- ✓ The reference contour field is displayed.

Multiple sampling and Object resolution

At first, the object resolution and multiple sampling configured for the monitoring plane apply for all fields. If necessary, you can make changes to each individually at a later date.

Tolerance band

A contour has a positive and a negative tolerance band. If the safety laser scanner does not detect the contour within the tolerance band, the field switches to the OFF state.

- **Positive tolerance (far):** The tolerance away from the safety laser scanner
- **Negative tolerance (near):** The tolerance toward the safety laser scanner

7.11 Fields

Overview

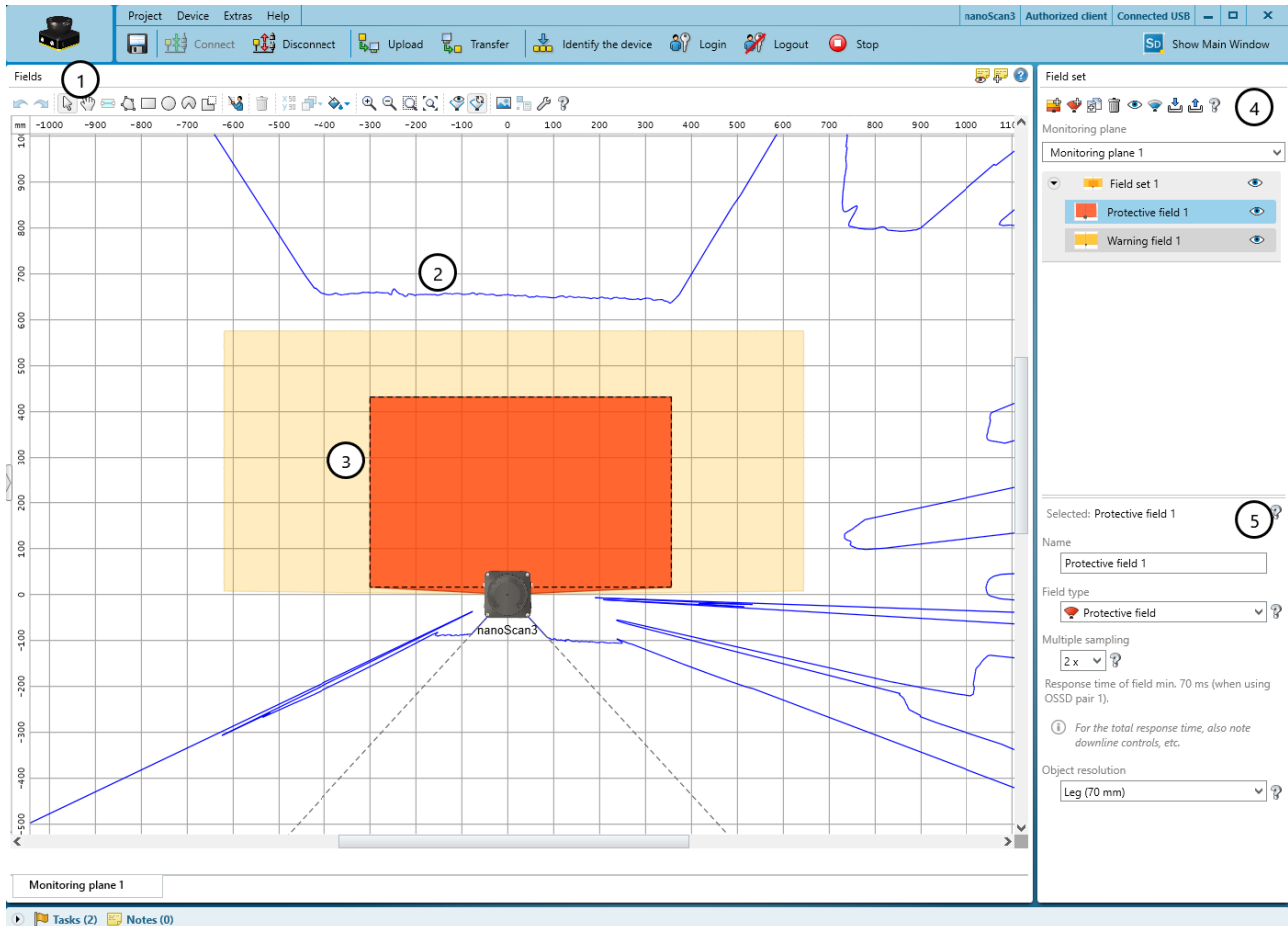

Figure 42: Field editor

- ① Toolbar
- ② Visible spatial contour
- ③ Protective field (red) and warning field (yellow) created
- ④ Create, copy, delete field set and fields
- ⑤ Define field type, name field, configure field

Using the field editor, you can configure the field sets of the safety laser scanner. The number of configurable fields depends on the safety laser scanner variant.

In the **Fields** area, you draw the fields in a field set using the tools in the toolbar. In the **Field set** area, you create the field sets and fields. In the area below, you configure details for the selected field set or field.



















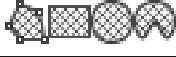



The edge length or the diameter of each field must be at least as large as the selected object resolution.

You can change the sequence of the fields in the **Field set** area using drag and drop. The fields of a field set are displayed in the monitoring case table in the same sequence in which you create them here.

Toolbar

Using the tools in the field editor, you can draw the fields in a field set or masked areas inside the fields.



Table 13: Buttons on the toolbar

| | |
|--|--|
|  | Arrow tool, for marking objects |
|  | Hand tool, for moving the work space |
|  | Draw reference contour field or contour detection field |
|  | Draw field using points |
|  | Draw rectangle |
|  | Draw circle |
|  | Draw circle segment |
|   | Mask areas. Clicking this button shows the buttons for drawing fields with a hatched display. You can then draw in areas that cannot be monitored. |
|  | Enable propose field |
|  | Editing a field using coordinates |
|  | Push the object into the foreground or background |
|  | Select field design |
|  | Zoom in |
|  | Zoom out |
|  | Zoom to area |
|  | Zoom to work space |
|  | Show snapshot of the spatial contour. Clicking again clears the spatial contour shown. |
|  | Show live spatial contour |
|  | Insert background image |
|  | Calculate field |
|  | Open field editor settings |

Field display

Safety Designer displays the field types in different colors.









Table 14: Colors of the field types

| Protective field | Warning field | Reference contour field and contour detection field |
|---|--|---|
|  |  |  |

| Protective field | Warning field | Reference contour field and contour detection field |
|------------------|---------------|---|
| Red | Yellow | Turquoise |

Create fields and field sets

Table 15: Buttons for field sets

| | |
|---|------------------------------------|
|  | Add field set |
|  | Add field to field set |
|  | Duplicate field set |
|  | Delete field or field set |
|  | Hide or show field sets and fields |
|  | Manage field set templates |
|  | Importing field sets and fields |
|  | Exporting field sets and fields |

Name

You can assign a unique name for each field set.

Name and Field type

You can assign a unique name and select a field type for each field.

Multiple sampling and Object resolution

At first, the object resolution and multiple sampling configured for the monitoring plane apply for all fields. If necessary, you can make changes to each individually at a later date.

Tolerance band

A contour has a positive and a negative tolerance band. If the safety laser scanner does not detect the contour within the tolerance band, the field switches to the OFF state.

- **Positive tolerance (far):** The tolerance away from the safety laser scanner
- **Negative tolerance (near):** The tolerance toward the safety laser scanner

7.11.1 Creating field set templates

Overview

If you require the same combination of fields a number of times, you can create a field set template.

Table 16: Manage field set templates

| | |
|---|----------------------------|
|  | Manage field set templates |
|---|----------------------------|

Procedure

1. Click on **Add field set template**.
2. Enter the name for the template.
3. Define the number of fields.

- ✓ A selection field is shown for each field.
- 4. Select the Field types for the fields.
- 5. Enter the Field names.
- 6. Click on **Apply**.
- ✓ The field set template is saved.

7.11.2 Importing and exporting field sets and fields

Overview

If you need identical field sets or fields across different projects, you can export entire field sets or individual fields out of one project and import them into another project.

Importing field sets and fields

1. Click on **Import fields and field sets**.
2. Select exported file with field set information.
- ✓ A preview of the field sets and fields saved in the file will be shown.
3. Select the required field sets and fields.
4. Start the import.
- ✓ The field sets and fields will be imported.

Exporting field sets and fields

1. Click on **Export fields and field sets**.
2. Select the relevant folder and enter a file name for storing the field set information.
3. Select the required field sets and fields.
4. Start the export.
- ✓ The field sets and fields will be exported.

7.11.3 Background image

Overview

You can select a background image for the field editor. For example, the plan view of the machine to be protected can be used as a sample.

The background image is saved in the project file on the computer. It is not transmitted to the device.

Table 17: Background image



The Safety Designer supports the following file formats: BMP, JPG, PNG.

Procedure

1. Click on **Edit background image** in the toolbar.
- ✓ The **Background image** dialog box opens.
2. Click on **Browse**
3. Select the file for the background image.
- ✓ Safety Designer displays the background image.
4. If necessary, use the pipette icon to select a color of the image to make this color transparent.
5. Adjust the size of the image with the scaling tool or by directly entering the dimensions. Use the scaling tool to move the tips of the blue arrow to two known points and then enter the distance between the points in the field.
6. Enter **X-Position**, **Y-Position** and **Rotation** in the coordinate system of the field editor. You can then freely move or rotate the background image in the field editor.

- 7. If necessary, click on the **Lock position of the image** option.
- ✓ It is no longer possible to change the background image in the field editor.

7.11.4 Settings for the field editor

Overview

Table 18: Settings for the field editor

| | |
|---|----------------------------|
|  | Edit field editor settings |
|---|----------------------------|

Field calculation

You specify whether the fields are calculated manually or automatically after drawing.

If you select the **Manual** option, first draw the areas to be monitored. Then click on **Calculate field sets** so that the Safety Designer calculates the field that the safety laser scanner actually monitors.

If you select the **Automatic** option, the drawn areas are immediately converted into fields.

Use global geometry

You specify whether global geometries are used.

Display reference contour field

You determine whether the reference contour field is displayed.

Drawing surface

You can use a Cartesian or a polar coordinates system and select the colors for the grid, the labels, and the drawing area.

7.11.5 Editing fields using coordinates

You can use coordinates to edit fields. Depending on the form on which a field is based, the appropriate input fields are displayed. The example shows a dialog box for a rectangle.

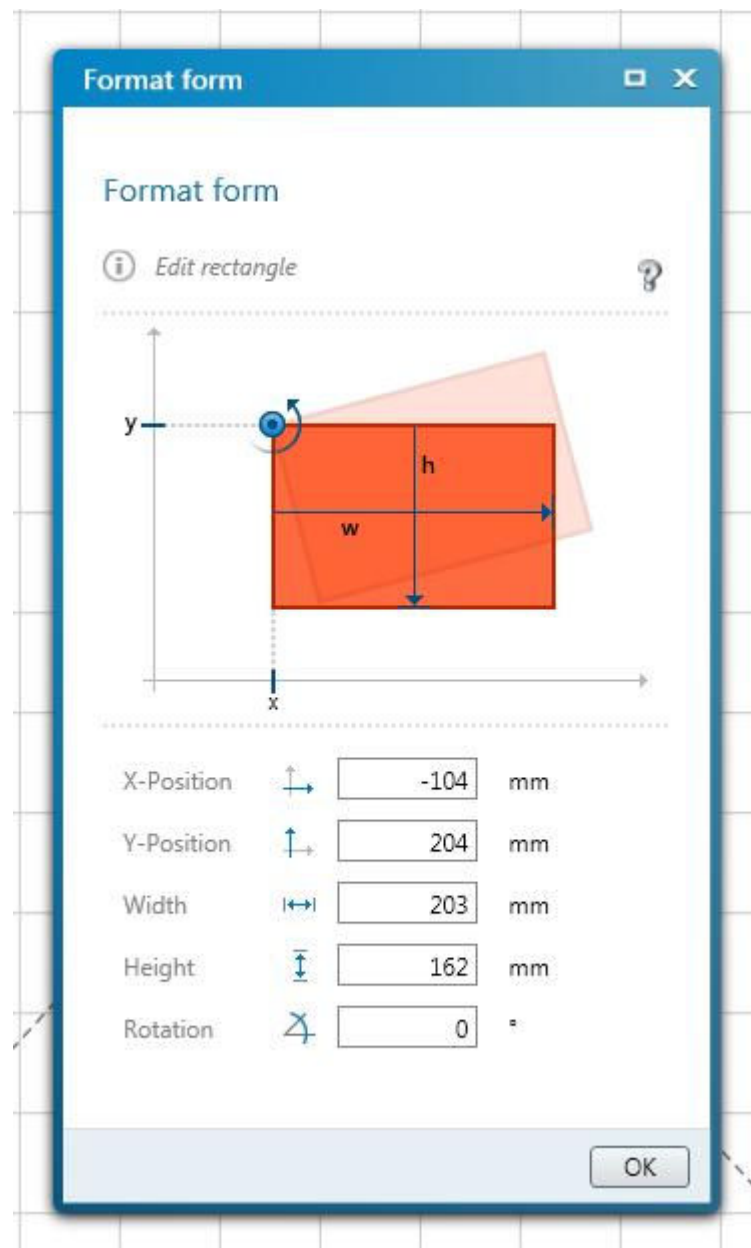

Figure 43: Editing fields using coordinates

The reference points for the X and Y values are as follows:

- Rectangle: top left corner
- Circle: center point
- Circle sector: center point
- Polygon: each point individually
- Contour line: each point individually

7.11.6 Drawing in points that cannot be monitored

Overview

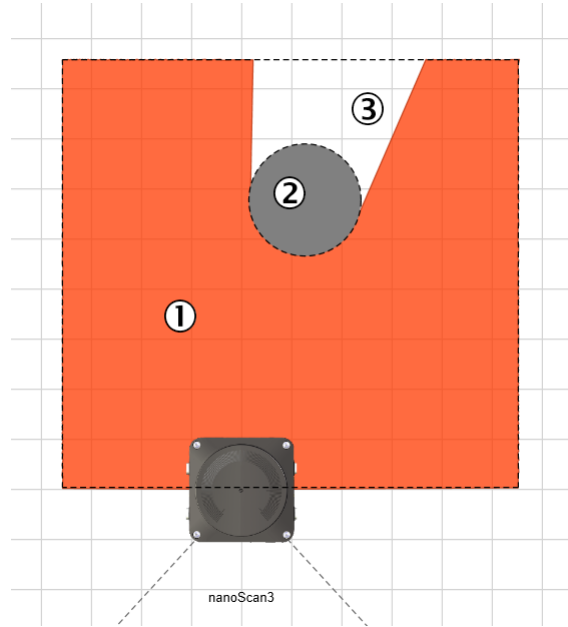



Figure 44: Area that cannot be monitored

- ① Protective field
- ② Marked column
- ③ Area that cannot be monitored

The area to be monitored is scanned radially ①. For this reason, shadows ③ are formed by objects in the room ② (support columns, separator grids, etc.). The safety laser scanner cannot monitor these areas.

You draw objects that limit the field of view of the safety laser scanner as masked areas.

Table 19: Mask areas

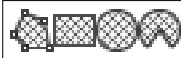
| | |
|---|-----------------------|
|  | Mask areas |
|  | Hatched drawing tools |

Procedure

1. Click on the **Mask areas** tool.
- ✓ The tools you can use to draw fields are shown crosshatched.
2. Choose a drawing tool.
3. Draw the masked area.
- ✓ The masked area is shown in gray.
- ✓ The field editor shows the shadowing of the masked area.

7.11.7 Defining global geometry

Overview

You draw field geometries and non-monitored areas as global geometry. The global geometry affects all protective fields and warning fields.

Table 20: Defining global field geometry

| | |
|---|----------------------------|
|  | Edit field editor settings |
|---|----------------------------|

Procedure

1. Click on the **Edit field editor settings** tool.
2. Activate the **Use global geometry** checkbox.
3. In the **Field set** area, select > **Global Geometry**.
4. Draw a global field geometry.
5. If applicable, draw non-monitored areas with the **Mask areas** tool.

7.11.8 Enable propose field

Overview

You can have a protective field or warning field suggested by Safety Designer.

For this purpose, the safety laser scanner scans the visible surrounding contour several times. Based on the data obtained, the Safety Designer suggests the contour and size of the field.

Table 21: Propose field

| | |
|---|---------------|
|  | Suggest field |
|---|---------------|

If you propose a protective field, the proposal does not replace calculation of the minimum distance. You must calculate the minimum distance and check whether the size of the proposed protective field is sufficient. You must also take into account the measurement tolerances of the safety laser scanner.

Existing field geometries

- **Delete existing shapes:** The field is redrawn according to the surrounding contour.
- **Refine existing shapes:** The existing field is adapted to the surrounding contour.

Measurement method

- **Use every single distance value:** Each scan of the surrounding contour is used individually to draw the field.
- **Use median of distance values:** The median of the last 25 scans is used to draw the field.

Type of teach-in

- **Only allow reduction:** The shortest measured distance is used at each angle. If you walk along the borders of the imaginary field and, for example, hold a board or cardboard into the laser beam, this restricts the surrounding contour.
- **Allow expansion:** The surrounding contour is used as it is measured.

Automatic reduction

You can specify that the proposed field is drawn smaller than the measured surrounding contour so that the field will be at a distance from walls. The default value corresponds to the TZ value (tolerance zone of the safety laser scanner).

Smoothing by point reduction

The proposed contour may initially be uneven and consist of very many points. With the **Smoothing by point reduction** option, you can reduce the number of points and simplify the lines.

Further topics

- "Distance from walls", page 30

7.12 Inputs and outputs, local

Overview

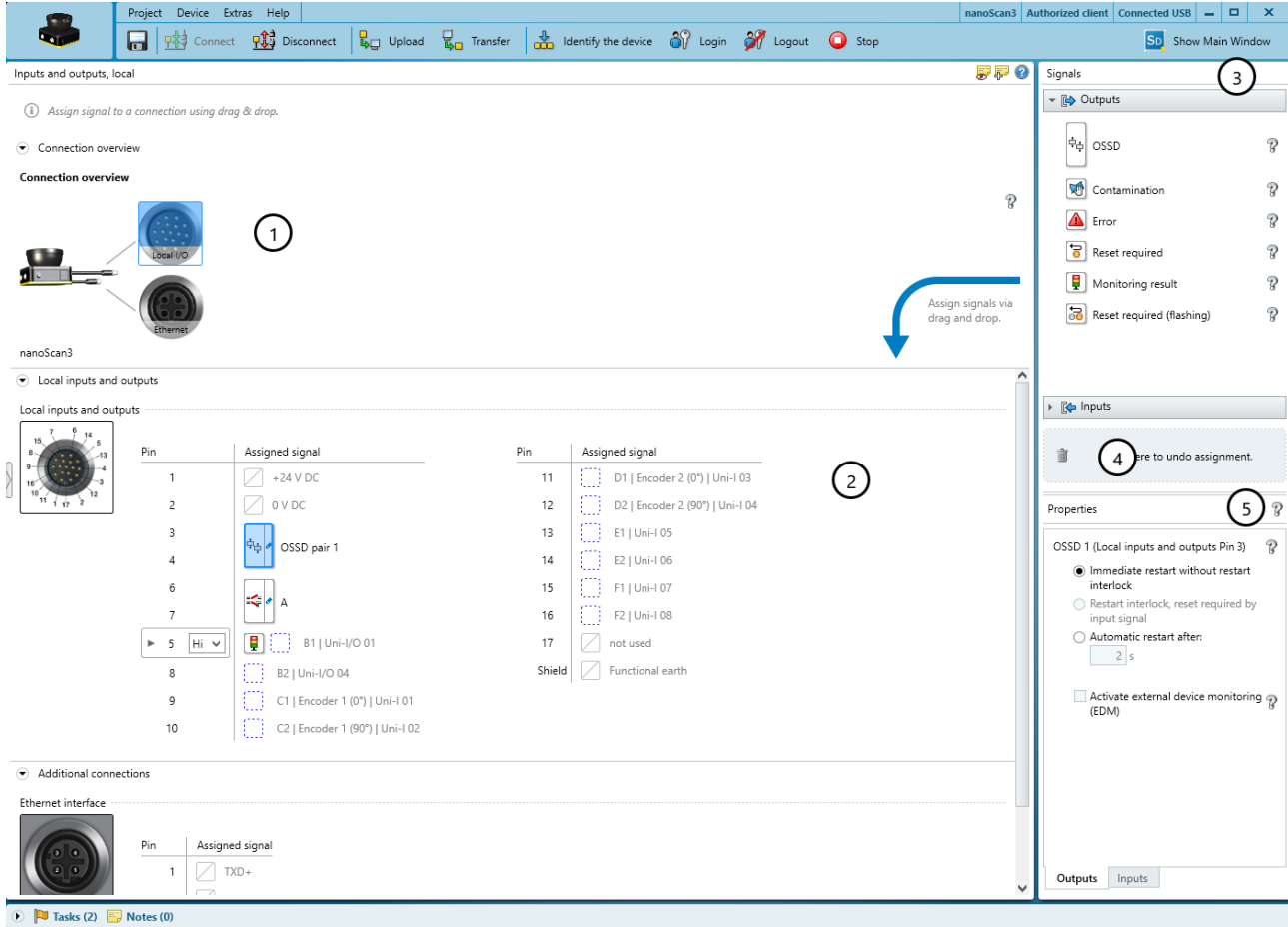

Figure 45: Inputs and outputs, local

- 1 Overview: Plug connectors of the safety laser scanner
- 2 Pin assignment
- 3 Available signals
- 4 Remove signal from connection
- 5 Further settings for some signals

Assign the required signals to the safety laser scanner connection in the **Inputs and outputs, local** dialog box.

Connection overview

Safety Designer shows the safety laser scanner's plug connectors and flying leads in the center of the dialog box.

Pin assignment

The Safety Designer shows the plug connectors with the individual pins and the individual wires of the flying leads.

Signals

Safety Designer shows the available signals on the right under **Signals**.

You can assign the desired signals to the individual pins or wires via drag-and-drop.

You can cancel the assignment by dragging a signal from a pin or wire onto the trash can icon.

Properties

Under **Properties**, you will find further adjustment options depending on the signals used.

7.12.1 Outputs

OSSD

Dual-channel, safety switching output which is used to switch off the dangerous state.

Contamination

Signals that the optics cover is contaminated.

- **Partial contamination, optical cover should be cleaned soon (contamination warning)**. setting: The optics cover should be cleaned soon.
- **Switch the safety laser scanner to the OFF state in the event of severe contamination (contamination error)**. setting: All safety outputs in the OFF state. The optics cover is severely contaminated and must be cleaned immediately.

Error

Signals an error.

- **Device error** setting: Device errors are serious errors where all safety outputs switch to the OFF state and the device switches to the locking state. Once the cause of the error has been rectified, the device must be completely restarted.
- **Application error** setting: In the event of an application error, all safety outputs switch to the OFF state. Once the cause of the error has been rectified, the safety function must be restarted.

Reset required

Signals that a reset is possible. A connected lamp lights up if the restart interlock has been triggered and the protective field is then clear again.

Monitoring result

Indicates the status of the active field. A connected lamp lights up if an object is detected in the field.

Reset required (flashing)

Signals that a reset is possible. A connected lamp flashes if the restart interlock has been triggered and the protective field is then clear again.

7.12.2 Inputs

Static control input

Signal of the machine controller for switching between monitoring cases.

Dynamic control input

For connecting an incremental encoder for speed-dependent switching between monitoring cases.

External device monitoring (EDM)

Signal from the auxiliary contacts of the positively guided contactors for external device monitoring (EDM).

Reset

Signal from the reset pushbutton to manually reset the internal restart interlock.

Sleep mode

Signal from a pushbutton to activate sleep mode.

Restart device

Signal from a pushbutton to completely restart the device.

Pause event recording

Signal of a pushbutton to stop the event history.

Further topics

- ["Static control inputs", page 43](#)

7.12.3 Further settings for some signals

Safety Designer shows the setting options for some signals under **Properties** at the bottom right.

Restart interlock for the OSSD pair

The safety laser scanner has the following options for the restart interlock behavior for the OSSDs:

- **Immediate restart without restart interlock:** If there is no longer an object in the protective field, the safety laser scanner switches the OSSDs to the ON state.
- **Restart interlock, reset required by input signal:** If the operator activates the restart or reset control switch, the safety laser scanner switches the OSSDs to the ON state.
- **Automatic restart after::** If there is no longer an object in the protective field, the safety laser scanner switches the OSSDs to the ON state after the configured delay.

Activate external device monitoring (EDM)

An input must be configured for external device monitoring (EDM). This input must be correctly connected to the electric control (see ["External device monitoring \(EDM\)", page 47](#)).

If external device monitoring is activated, the safety laser scanner checks whether voltage is applied at the external device monitoring (EDM) input after the OSSDs have been switched off.

If no voltage is applied at the input after the OSSDs have been switched off, the safety laser scanner changes to the locking state and does not switch the OSSDs back to the ON state.

Signal level

For some non-safe output signals, you can select whether the signal is output with HIGH or with LOW:

- **Setting Hi:** The output is normally in LOW state. If the signal is active, the output switches to HIGH state.
- **Setting Lo:** The output is normally in HIGH state. If the signal is active, the output switches to LOW state.

Speed

For dynamic inputs, you must specify for each incremental encoder how many pulses it outputs per distance traveled.

For dynamic inputs, you must also specify the tolerance by which the measured speeds of the two incremental encoders are allowed to deviate from one another, e.g., when cornering. The value is given as a percentage of the higher of the two speeds (whether forwards or backwards). In case of differences, the speed with the higher value is always used. The tolerance is allowed to be exceeded for a certain period of time. The safety laser scanner then switches the safety outputs to the OFF state.

The period of time depends on the vehicle speed:

- Vehicle speed $-10 \text{ cm/s} \dots +10 \text{ cm/s}$: No shut-off, no matter how large the deviation between the measured speeds is.
- Vehicle speed $-30 \text{ cm/s} \dots -10 \text{ cm/s}$ or $+10 \text{ cm/s} \dots +30 \text{ cm/s}$: The tolerance is allowed to be exceeded for a maximum of 60 seconds.
- Vehicle speed $\leq -30 \text{ cm/s}$ or $\geq +30 \text{ cm/s}$: The tolerance is allowed to be exceeded for a maximum of 20 seconds.
- Vehicle speed in the range $\leq -10 \text{ cm/s}$ or $\geq +10 \text{ cm/s}$: Different directions of rotation of the incremental encoders are tolerated for a maximum of 0.4 s.

7.13 Monitoring cases

Overview

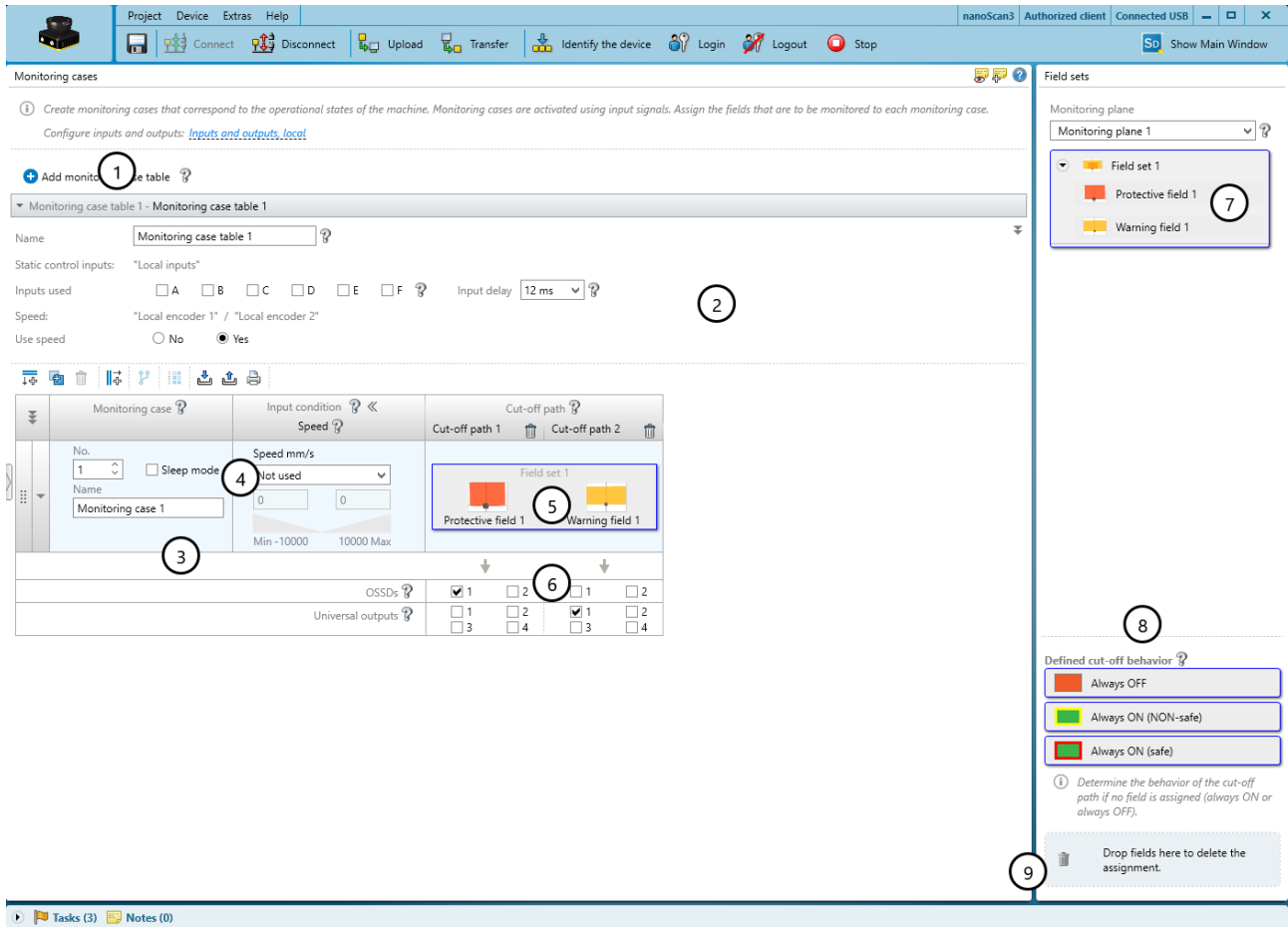

Figure 46: Monitoring cases

- ① Add monitoring case table
- ② Settings for the whole monitoring case table
- ③ Settings for the individual monitoring case
- ④ Input conditions for a monitoring case
- ⑤ Field set in the monitoring case and in the cut-off path
- ⑥ Cut-off paths
- ⑦ Configured field sets
- ⑧ Areas for defined cut-off behavior
- ⑨ Remove field set from a monitoring case

In the monitoring case editor, you can also define the monitoring cases with input conditions and assign the field sets.

7.13.1 Settings for monitoring case tables

Name

In the **Name** field, you can enter a meaningful name for the monitoring case table.

Inputs used

You choose the inputs that you would like to use for switching between monitoring cases in the monitoring case table.

Input delay

In the **Input delay** field, you can select a delay for the inputs.

If your control device, which you use to switch the static control inputs, cannot switch to the appropriate input condition within 12 ms (for example because of the switch's bounce times), you must configure an input delay. The selected input delay must be large enough to allow your control device to switch to the new input condition within this time.

Table 22: Empirical values for the required input delay

| Switchover method | Required input delay |
|---|----------------------|
| Electronic switching via control, complementary electronic outputs with 0 ms to 12 ms bounce time | 12 ms |
| Tactile controls (relays) | 30 ms to 150 ms |
| Control via independent sensors | 130 ms to 480 ms |

Use speed

If you want to use the speed for monitoring case switching or as an additional condition, activate this option.

Importing and exporting monitoring case tables

If you need identical monitoring case tables across different projects, you can export monitoring case tables out of one project and import them into another project.

Further topics

- ["Monitoring case switching time", page 25](#)
- ["Static control inputs", page 43](#)

7.13.1.1 Configure switching sequence

Overview

You can specify the order in which the monitoring cases can be called.

You can specify one or two subsequent monitoring cases for each monitoring event. If you do not specify a subsequent monitoring case for a monitoring case, then any monitoring case may follow.

If input conditions are present that do not call up any of the defined subsequent monitoring cases, the safety laser scanner switches all safety outputs to the OFF state.

You can specify the order of the monitoring cases as a process or in individual steps.

Process

You define one or more sequences. You can use a sequence to map the sequence of work steps for your machine.

In all sequences, you can define a maximum of two subsequent monitoring cases for each monitoring case.

If you do not specify a subsequent monitoring case for a monitoring case, then any monitoring case may follow.

Individual steps

You define individually for each monitoring case which one or two monitoring cases may follow.

If you do not specify a subsequent monitoring case for a monitoring case, then any monitoring case may follow.

Complementary information

You can use the changeover order as an additional check of your control unit. For example, deviations of a vehicle from the route or a plant from the prescribed production process can be detected.

7.13.2 Several monitoring case tables

Certain variants of the safety laser scanner support multiple simultaneous monitoring case tables. For example, you can use a monitoring case table to switch between different monitoring cases with different field sets. At the same time, you can use another monitoring case table to keep a monitoring case always active with a particular field set.

Even if you use several monitoring case tables, each shutdown path is assigned to only one monitoring case table.

If you use several monitoring case tables, one monitoring case must be active in each monitoring case table at all times. As long as no monitoring case is active in a monitoring case table after the start, all outputs remain in the OFF state and the device displays **Waiting for inputs**. If no monitoring case is active in a monitoring case table during operation, all outputs switch to the OFF state and the device displays an error.

7.13.3 Settings for monitoring cases

Name

In the **Name** field, you can enter a meaningful name for the monitoring case. If you create a lot of monitoring cases, you should consider a naming concept that makes it possible to identify the monitoring cases easily (for example right cornering, left cornering).

Sleep mode

If you activate this option, the safety laser scanner changes to the sleep mode as soon as the input conditions for this monitoring case exist.

7.13.4 Input condition

For each monitoring case, you choose the input conditions for which the monitoring case will be activated. The relevant monitoring case is activated for exactly this combination.

Combinations which are invalid or already assigned are marked.

Speed

- **Range:** The monitoring case is activated if the speed is within the specified range. You can use static control inputs as additional input conditions.
- **Limit:** The monitoring case is activated via the static control inputs. The safety laser scanner monitors the speed. If the speed is outside the specified range, the safety laser scanner switches the safety outputs to the OFF state.
In this mode, the safety laser scanner ignores different speeds of the two incremental encoders for 60 seconds, even if the difference is greater than the configured tolerance.

Complementary information

The **Generate input conditions** function allows you to automatically assign input conditions to monitoring cases.

7.13.5 Cut-off paths

Overview

You can create cut-off paths and define the outputs switched by the cut-off paths.

You need a cut-off path for every field in a field set. If the field sets have different sizes, use the field set with the most fields as a guide.

Cut-off path

You can enter a meaningful name for each shutdown path.

Outputs

You select the outputs that the cut-off path should switch:

- OSSDs
- Universal outputs

7.13.6 Assigning field sets

Overview

The field sets that have been created are listed in the **Field sets** area.

Procedure

Assign a field set to a monitoring case

- ▶ Assign a field set to a monitoring case using drag and drop.
- ✓ The fields in a field set are arranged as they were drawn in the field editor.

Assigning a field to a monitoring case

1. Assign a field set to a monitoring case using drag and drop.
2. Right click on the assigned field set and select **Split fieldset**.
3. Assign the individual fields to one or various monitoring cases.

Removing assignment

- ▶ Drag a field set or field from a monitoring case onto the trash can icon.

7.13.7 Assigning a defined cut-off behavior

Overview

In a monitoring case, you can assign a defined cut-off behavior to a cut-off path instead of a field:

- **Always OFF:** If the monitoring case becomes active, the cut-off path is always in the OFF state.
- **Always ON (NON-safe):** If the monitoring case becomes active, a safety output in the cut-off path is always in the OFF state. A non-safety output is always in the ON state.
- **Always ON (safe):** If the monitoring case becomes active, the cut-off path is in the ON state.

Procedure

Assigning a defined cut-off behavior

- ▶ Assign a cut-off behavior to a cut-off path in a monitoring case using drag-and-drop.

Complementary information

If you have not assigned fields to certain cells in a monitoring case table, Safety Designer automatically assigns the **Always OFF** function to these cells.

7.13.7.1 Configuring the default settings for defined cut-off behavior

Overview

With this function, you can define specified cut-off behaviors per cut-off path as default settings for monitoring cases.

Table 23: Show/hide preset for specified cutoff behavior

| | |
|---|--|
|  | Show/hide preset for specified cutoff behavior |
|---|--|

Procedure

1. Select **Show/hide preset for specified cutoff behavior**.
- ✓ Safety Designer displays an additional line in the monitoring case table.
2. Assign a cut-off behavior to a cut-off path in the **Preset for specified cutoff behavior** cell using drag and drop.
- ✓ Safety Designer applies the default settings when you add a new monitoring case.

7.14 Simulation

Overview

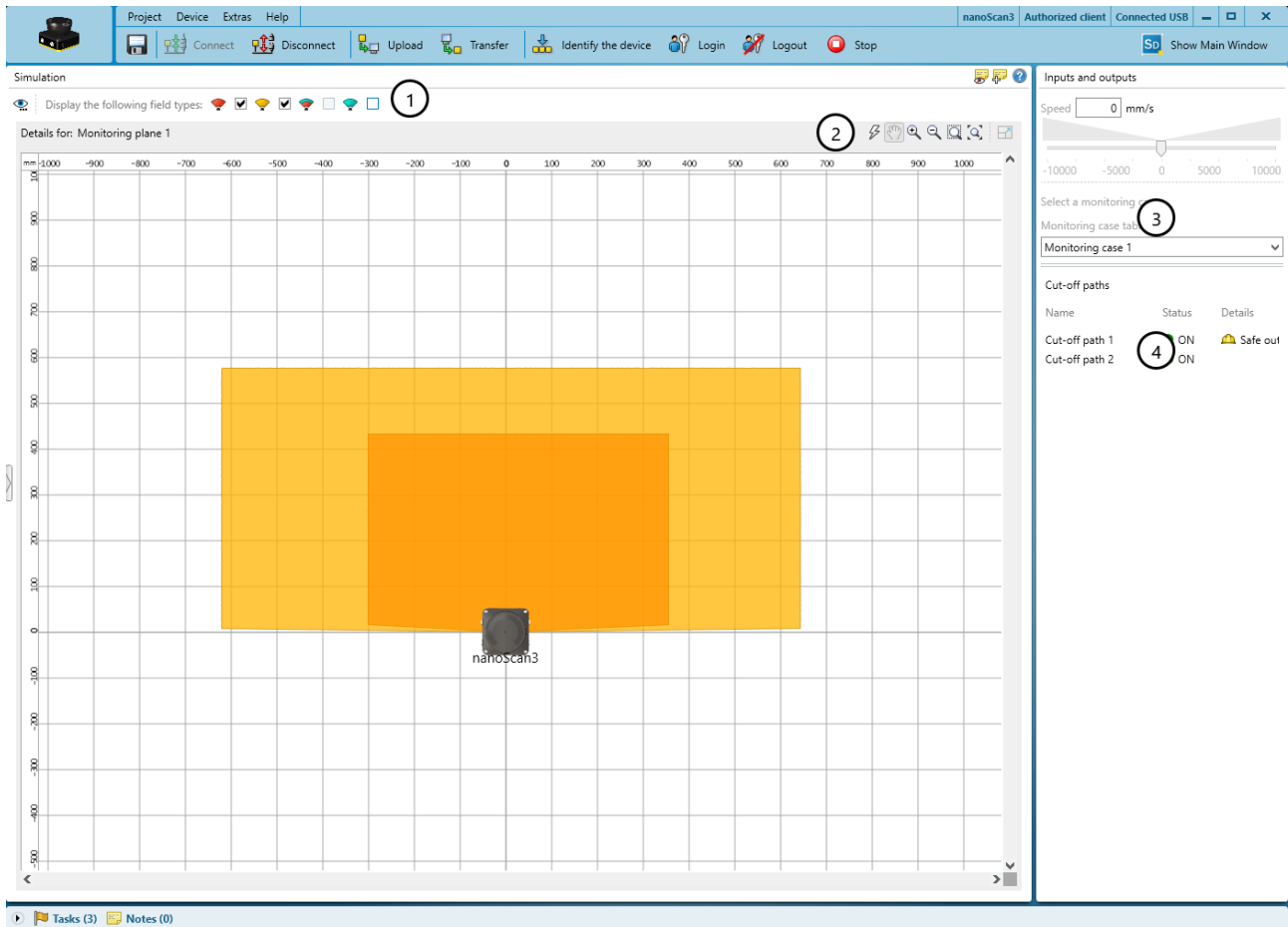

Figure 47: Simulation

- ① Show or hide field types
- ② Simulation tools
- ③ Select input conditions
- ④ Display the cut-off paths

You can visualize the result of the set configuration in the simulation.

Simulation components and options

- Display the status of the cut-off paths
- Feedback about which monitoring case is active for the selected input sample
- You can switch inputs, monitoring cases, etc. virtually using symbols and observe the result.
- You can simulate an object detection in a field and check the result.
- You can move fields to the foreground or to the background using the context menu (right mouse button).

7.15 Data output

Overview

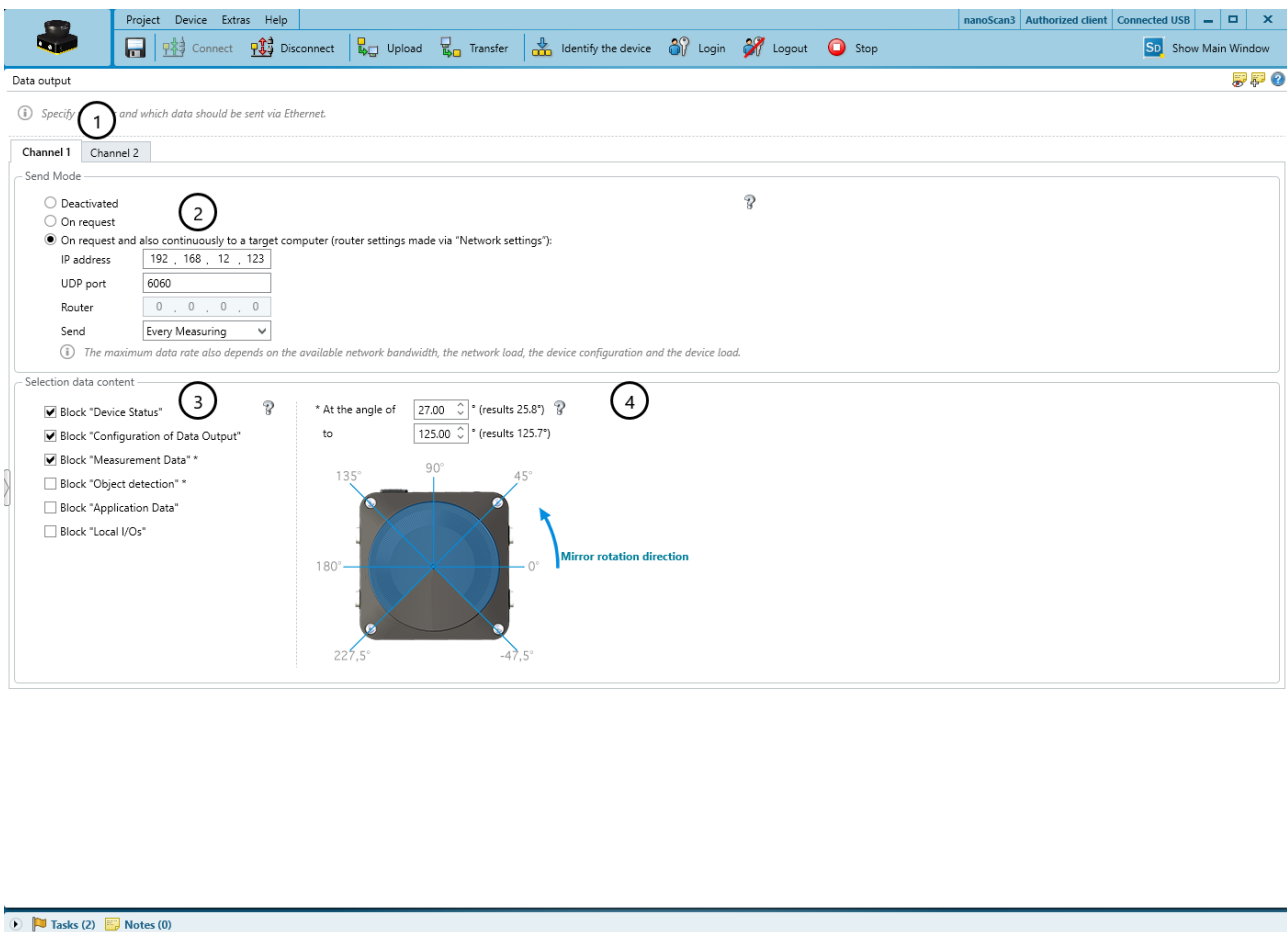

Figure 48: Data output

- ① Data output channel
- ② Send mode
- ③ Data content
- ④ Angular range

Data output can be used for general monitoring and control tasks. This data is used in particular for providing navigation support for AGVs (automated guided vehicles). This data must not be used for safety-related applications.

Data output channel

Every data output channel has independent settings.

Send Mode

- **Deactivated:** No data output
- **On request:** Data is output when there is an explicit request from a host computer via TCP/IP using CoLa 2
- **On request and also continuously to a target computer (router settings made via "Network settings"):** Data is output continuously via UDP to a defined target address and also when there is an explicit request from a host computer via TCP/IP using CoLa 2

Selection data content

- **Block "Device Status":** Information on the status of the safety laser scanner (e.g., cut-off paths, errors)
- **Block "Configuration of Data Output":** Information on the actual angle range used (due to technical conditions, data may be output from a slightly larger angle range than the set angle range)
- **Block "Measurement Data" *:** Distance data with reflector detection and RSSI
- **Block "Object detection" *:** Data on the beams in the fields of the active monitoring case in which an object was detected
- **Block "Application Data":** State of the inputs and outputs used in the monitoring case table
- **Block "Local I/Os":** State of the local inputs and outputs

Angular range

You define in which range measurement data and data on detections in fields are output.

Complementary information

For more information on data output, see the technical information "microScan3, outdoorScan3, nanoScan3: Data output via UDP and TCP/IP" (part number 8022706).

7.16 Transferring a configuration

Overview

A configuration is first saved in your Safety Designer project as a configuration file. You transfer the configuration to the connected device.

At the left, you see the values configured in the project for the device. If the device is connected, you see the values saved in the device at the right.

The compatibility of the configuration is checked during transmission. An existing configuration on the device is overwritten.

Procedure

1. Check the configuration carefully before transmission.
2. Click on **Identify the device** to ensure that the desired device is connected.
 - ✓ The display of the connected device flashes blue.
3. If the checksums on the computer and the device differ, click on **Transfer to device**.
 - ✓ The transmission process is shown in Safety Designer and on the device.
 - ✓ Safety Designer will notify you as soon as the transfer process is complete.

Further topics

- ["Verify configuration", page 93](#)

7.16.1 Verify configuration

Overview

By verifying the configuration, you can confirm that the configuration complies with the planned safety function and fulfills the requirements in the risk assessment.

During verification, Safety Designer reads back the configuration transferred to the device. It compares the configuration with the configuration saved in Safety Designer. If both configurations are identical, Safety Designer displays the verification report. If the user confirms that this is correct, the system is considered to be verified.

Important information



DANGER

Hazard due to lack of effectiveness of the protective device

Errors can occur when transferring the configuration to the device, e.g., due to environmental influences or faulty cables. The verification report always contains exactly the settings that are stored in the device.

- ▶ Before confirming, check the verification report carefully.

Prerequisites

- The configuration corresponds to the planned safety function and meets the requirements of the risk assessment.
- The configuration has been transferred to the device.

Procedure

1. Click on **Verify**.
 - ✓ Safety Designer displays the verification report.
2. Thoroughly review the verification report.
 - ▶ If the verification report does not match the planned safety function, click on **Cancel**, correct the configuration and start again from step 1.
 - ▶ If the verification report matches the planned safety function, click on **OK**.
- ✓ Device configuration is shown as verified.

Complementary information

If the configuration is verified, the device automatically starts the safety function after switching on the voltage supply.

If the configuration is not verified, the device may not be operated as a protective device. You can start the safety function manually to test the device and the configuration. The test operation has a time limit.

Further topics

- ["Starting and stopping safety function", page 93](#)

7.17 Starting and stopping safety function

Overview

In some situations, for example tests during commissioning, you can start or stop the safety function manually.

Procedure

Start safety function

- ▶ Click on the  button.

Stop the safety function

▶ Click on the  button.

7.18 Report

Overview

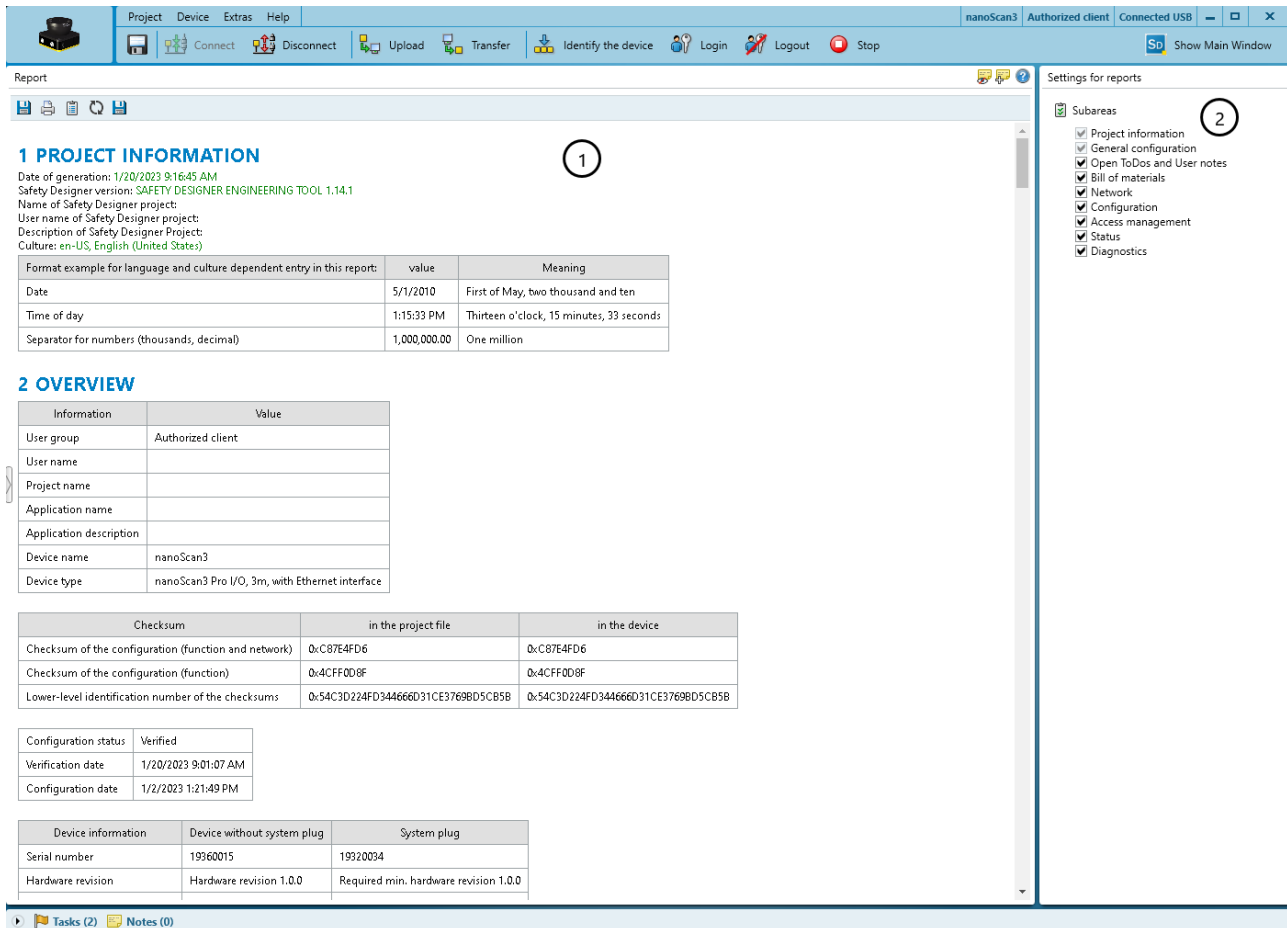

1 PROJECT INFORMATION

Date of generation: 1/20/2023 9:16:45 AM
 Safety Designer version: SAFETY DESIGNER ENGINEERING TOOL 1.14.1
 Name of Safety Designer project:
 User name of Safety Designer project:
 Description of Safety Designer Project:
 Culture: en-US, English (United States)

| Format example for language and culture dependent entry in this report: | value | Meaning |
|---|--------------|--|
| Date | 5/1/2010 | First of May, two thousand and ten |
| Time of day | 1:15:33 PM | Thirteen o'clock, 15 minutes, 33 seconds |
| Separator for numbers (thousands, decimal) | 1,000,000.00 | One million |

2 OVERVIEW

| Information | Value |
|-------------------------|--|
| User group | Authorized client |
| User name | |
| Project name | |
| Application name | |
| Application description | |
| Device name | nanoScan3 |
| Device type | nanoScan3 Pro I/O, 3m, with Ethernet interface |

| Checksum | in the project file | in the device |
|--|------------------------------------|------------------------------------|
| Checksum of the configuration (function and network) | 0xC87E4FD6 | 0xC87E4FD6 |
| Checksum of the configuration (function) | 0x4CFF008F | 0x4CFF008F |
| Lower-level identification number of the checksums | 0x54C3D224FD344666D31CE3769B05CB5B | 0x54C3D224FD344666D31CE3769B05CB5B |

| | |
|----------------------|----------------------|
| Configuration status | Verified |
| Verification date | 1/20/2023 9:01:07 AM |
| Configuration date | 1/2/2023 1:21:49 PM |

| Device information | Device without system plug | System plug |
|--------------------|----------------------------|---------------------------------------|
| Serial number | 19360015 | 19320034 |
| Hardware revision | Hardware revision 1.0.0 | Required min. hardware revision 1.0.0 |

Settings for reports

Subareas

- Project information
- General configuration
- Open ToDos and User notes
- Bill of materials
- Network
- Configuration
- Access management
- Status
- Diagnostics

Figure 49: Report

- ① Contents of the report
- ② Composition of the report

A report shows the settings and data of a device. You have the option of saving and archiving these data as a PDF.

Report

When you open the **Report** dialog box, the Safety Designer creates a report. If you click on **Update** after making changes to the configuration, you will receive an updated report.

Composition of the report

You can assemble the contents of the report as required.

Complementary information

National and international standards promote or recommend specific data and the person responsible for it. The required data are included in the report.

7.19 Service

7.19.1 Restart device

If you have problems with the device, you can restart the device or subsections of the device (safety function, connections, additional functions).

Restarting safety function

- The fastest type of restart
- Serious errors remain, even if the cause has been rectified (for example a locking state because of a supply voltage which is too low).
- Communication with the device remains intact (connections for configuration, safety function and data not relating to safety).
- Communication beyond the device is not impaired.

Restarting safety function and connections

- The device's function is also re-established after serious errors if the cause has been rectified.
- Communication with the device is interrupted (connections for configuration, safety function and data not relating to safety). The device sets up communication again automatically after restarting.
- Communication beyond the device is not impaired.

Restarting device completely

- The device behaves exactly as it does when the voltage supply is switched off and back on again.
- The device's function is also re-established after serious errors if the cause has been rectified.
- Communication with the device is interrupted (connections for configuration, safety function and data not relating to safety).
- Communication beyond the device is interrupted. This may also affect devices which communicate beyond the device.

7.19.2 Factory settings

Overview

Before reconfiguring the device, you can reset all settings to factory settings.

Resetting safety function to factory settings

- The configuration for the safety function is reset to factory settings.
- Communication beyond the device is not impaired.

Resetting safety function and communication settings to factory settings

- The configuration for the safety function is reset to factory settings.
- The configuration of device communication is reset to factory settings (connections for configuration, safety function and data not relating to safety).

Resetting complete settings to factory settings

- The configuration for the safety function is reset to factory settings.
- The configuration of device communication is reset to factory settings (connections for configuration, safety function and data not relating to safety).
- The **Maintenance personnel** and **Authorized client** user groups are deactivated.
- The password of the **Administrator** user group is reset to the factory settings.

7.19.3 Managing passwords

Assigning or changing passwords

1. Establish connection to the device.
 2. In the device window under **Service**, select the **User password** entry.
 3. In the **User password** dialog box, select the user group.
 4. Enter the new password twice and confirm with **Transfer to device**.
 5. When you are prompted to log on, select your user group and enter the corresponding password.
- ✓ The new password is valid for the user group immediately.

Reset password

If you have forgotten the password of the **Administrator** user group, you can reset it with the assistance of SICK.

1. Request the form for resetting your password from SICK support.
 2. Connect to the device in Safety Designer.
 3. In the device window under **Service**, select the **User password** entry.
 4. In the **User password** dialog box, select the **Start process for resetting the password** option.
 5. Send the information displayed on the form to SICK support.
- ✓ You will then receive an activation code.
6. If the device is connected via network: On the display of the device in the relevant menu, allow the resetting of the password by pressing the OK pushbutton.
 7. Enter and confirm the activation code in the field provided in Safety Designer.
- ✓ The password of the **Administrator** user group is reset to factory settings (SICKSAFE). The **Maintenance personnel** and **Authorized client** user groups are deactivated. The configuration is not changed.

7.19.4 Access management

Overview

You can activate or deactivate interfaces and selected functions as needed.

In the **Projected device** area, you can see the settings in the project.

When a device is connected, you can see in the **Physical device** area the configuration in the device and the status describing the actual behavior of the device.

Older devices may not support all settings.

Functions and settings

You can activate, deactivate or select the default setting for each function displayed. The default setting depends on the device and its range of functions.

Safety Designer displays the minimum functionality that the device must have to support the setting.

Behavior if the "deactivated" setting is not supported by the device or replacement device:

It may happen that settings are stored in the system plug that the device cannot evaluate, e.g., because a device has been replaced by an older device. You can set how the device should behave in this case.

Older devices ignore all settings in this window. Safety Designer shows up to which functional range the settings are ignored.

7.19.4.1 Functions and settings

Device restart (without network) via device display

You can specify whether the device can be restarted using the pushbuttons on the display.

Ethernet Port 1 ⁴⁾

You can activate or deactivate the network connection.

Ethernet CoLa 2 (Device configuration and diagnosis)

The CoLa 2 interface enables device configuration and diagnostics with Safety Designer via network. For information on further functions of the CoLa 2 interface, refer to the technical information “microScan3, outdoorScan3, nanoScan3: Data output via UDP and TCP/IP” (part number 8022706).

As soon as the interface is deactivated, no new connections can be established. An existing connection remains open until it is closed or the timeout expires.

7.19.5 Optics cover calibration

Overview

After replacing an optics cover, the measurement system of the safety laser scanner must be calibrated to the new optics cover. During optics cover calibration, the reference for the contamination measurement of the optics cover is defined (status = not contaminated).

Important information



WARNING

Incorrect reference value of optical properties

If optics cover calibration is not done correctly, persons and parts of the body to be protected may not be detected.

- ▶ Carry out an optics cover calibration with the Safety Designer every time the optics cover is replaced.
- ▶ Carry out the optics cover calibration at room temperature (10 °C to 30 °C).
- ▶ Only carry out the optics cover calibration using a new optics cover.
- ▶ Before the optics cover calibration switch on the device for a few minutes to warm up the internal components.
- ▶ Make sure that the entire system is clear of contamination when the adjustment is carried out.

Procedure

1. Before the optics cover calibration, switch on the device for a few minutes to warm up the internal components.
 2. In the **Exchange** column, click on **Yes**.
 3. Check that the optics cover is clean.
 4. In the **Check cleanliness** column, click on **OK**.
 5. In the **Optical cover calibration** column, click on **Start**.
- ✓ The calibration process starts. Typically, this process can take up to a minute. A progress bar shows the progress.

⁴⁾ The network connection is available for certain system plugs.

- 6. Do not switch off the safety laser scanner and do not disrupt the connection between the computer and the safety laser scanner during the adjustment.
- ✓ The end of the calibration is shown.

7.19.6 Compare configuration

Overview

You can use this function to compare the current configuration in the device window with a previously exported configuration or the configuration in the device.

Exported configurations are stored in their own format: “.sdsc”. You can export a configuration under **Service > Compare configurations** in the **Current configuration of project** area in the device window.

Prerequisites





- The configuration export contains only one device.
- Type code of the device is identical in both configurations.
- Version number of the functionality is identical in both configurations.

Procedure

1. In the navigation menu of the device window, navigate to **Service > Compare configurations**.
- ✓ The Safety Designer shows the current device configuration at the top left of the workspace.
2. Reading in comparison data:
 - Reading a configuration from the device: Open the drop-down menu next to the device symbol and select **Read from Device**.
 - Importing a configuration file: Select and import a previously exported configuration file using **Import data**.
 - Use the current configuration in the device window: Select **Use comparison data**.
- ✓ The Safety Designer starts the configuration comparison and displays the results in a table in the workspace.
3. If necessary, export the comparison result as a .csv file using **Export result** via the comparison table.

Complementary information

Table 24: Buttons

| Button | Description |
|---|---|
|  | Current configuration of project area: Exports the current configuration in the “.sdsc” format for another comparison |
| | Comparison data area: Exports the comparison configuration in the “.sdsc” format |
| | Via the comparison table: Exports the comparison result |
|  | Imports the configuration file in the “.sdsc” format |
|  | Identifying the device |
|  | Reads the configuration from the device |
|  | Updates the configuration comparison |

8 Commissioning

8.1 Safety

Important information



WARNING

Dangerous state of the machine

The machine or the protective measure may not yet behave as you have planned

When changes are made to the machine, the effectiveness of the protective measure may be affected unintentionally.

- ▶ Before commissioning the machine, make sure that the machine is first checked and released by qualified safety personnel.
 - ▶ Only operate the machine with a perfectly functioning protective device.
 - ▶ Check the effectiveness of the protective measure after each change to the machine, the integration or the operating and boundary conditions of the safety laser scanner. Perform commissioning again.
-

8.2 Overview

Prerequisites

- Project planning has been completed.
- Mounting is complete.
- Electrical installation is completed.
- Configuration is completed.
- No-one is in the hazardous area during commissioning.

Further topics

- ["Project planning", page 20](#)
- ["Mounting", page 53](#)
- ["Electrical installation", page 55](#)
- ["Configuration", page 60](#)

8.3 Alignment

Overview

Various options are available for precisely aligning the safety laser scanner depending on the mounting kit that is used.

Procedure

1. Align the safety laser scanner.
2. Tighten the screws to the specified tightening torque.
3. Check alignment.

8.4 Switching on

After switching on, the safety laser scanner performs various internal tests. The OFF LED illuminates continually. The ON LED is off.

When the start procedure is complete, the status LEDs and the display show the current operational status of the safety laser scanner.

Further topics

- ["Troubleshooting", page 112](#)

8.5 Check during commissioning and modifications

The thorough check is intended to ensure that the safety functions are fulfilling their planned purpose and whether persons are being adequately protected.

- ▶ Carry out the checks specified in the test plan of the manufacturer of the machine and the operating entity.

9 Operation

9.1 Safety



NOTE

This document does not provide instructions for operating the machine in which the safety laser scanner is integrated.

9.2 Regular thorough check

The thorough check is intended to ensure that the safety functions are fulfilling their planned purpose and whether persons are being adequately protected.

- ▶ Carry out the checks specified in the test plan of the manufacturer of the machine and the operating entity.

9.3 Status indicators

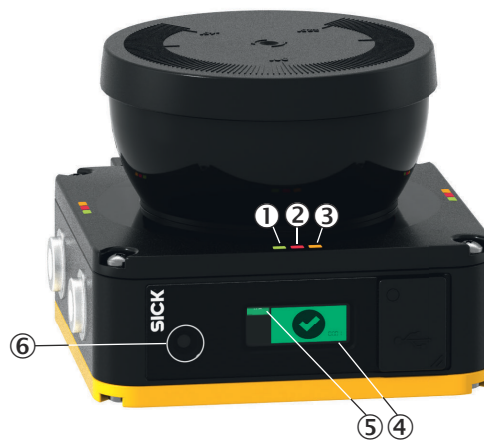

- ① LED ON status
- ② LED OFF status
- ③ LED restart interlock/warning field
- ④ Display
- ⑤ Network LED
- ⑥ Button

Table 25: Status LEDs

| Number | Function | Color | Meaning |
|--------|-----------|-------|---|
| ① | ON state | Green | Lights up green when at least one safety output is in the ON state. |
| ② | OFF state | Red | Lights up red when at least one safety output is in OFF state due to an interrupted field. Flashes red when a safety output is in the OFF state due to an error. |

| Number | Function | Color | Meaning |
|--------|---------------------------------|--------------------------|---|
| ③ | Restart interlock/warning field | Yellow | Setup with reset: Flashes if the restart interlock has been triggered. Configuration with automated restart after a time: Lights up while the configured time to restart expires. Warning field: Lights up yellow if at least one warning field is interrupted. |
| ④ | Display | Red/yellow/green | Information about the status of the safety laser scanner |
| ⑤ | Network LED | Yellow/green | <ul style="list-style-type: none"> Lights up green: Ethernet connection established. Flashes yellow: Data are being transmitted. |
| ⑥ | Button | Operation of the display | |

The the ON state, OFF state and restart interlock/warning field LEDs are arranged in three sets on the base of the optics cover so that they are clearly visible from all directions.

Complementary information

The display elements are only used for diagnostic purposes and are not safety-relevant. The safety function of the device is not impaired even if the status indicators are incorrectly displayed or fail.

9.4 Status indicator with the display

Overview



The display shows current information about the status of the safety laser scanner. The display switches off after approx. 60 s if all fields are clear and no other notification is displayed.

Procedure









- ▶ If the display is switched off, press any button briefly to activate the display.
- ▶ Press the button briefly to obtain more details about the displayed status information.
- ▶ If there are a number of pages with detailed information, this is shown in the top right of the display. Press the button briefly to change between a number of pages with detailed information.

Status indicator

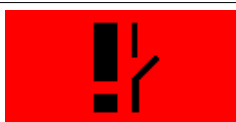
Table 26: Overview of status information

| Display | Device or configuration | Meaning |
|---|--|--|
|  | All devices and configurations | All fields clear, safety outputs in ON state. The number at bottom right indicates the active monitoring case. |
|  | Devices and configurations with a configured safety output | Protective field interrupted, safety output in OFF state. |

| Display | Device or configuration | Meaning |
|---|---|--|
|  | Devices and configurations with 2 configured safety outputs | For the cut-off paths of both safety outputs, the following applies: the protective field is interrupted or there is a warning field in the active monitoring case. Safety outputs in the OFF state. Each column stands for a safety output. |
|  | Devices and configurations with 2 configured safety outputs | The protective field in the cut-off path of safety output 1 is interrupted or there is a warning field in the active monitoring case. The safety output is in the OFF state. Safety outputs for which no field is interrupted and which are in the ON state are marked with their number. |
|  | Devices with 2 safety outputs if only safety output 2 is configured | The protective field in the cut-off path of safety output 2 is interrupted or there is a warning field in the active monitoring case. The safety output is in the OFF state. Safety outputs that are not configured are not marked. |
|  | Configuration with restart interlock | Protective field is clear, reset can take place. |
|  | Configuration with restart interlock | Reset button pressed. Safety output in the OFF state. |
|  | Configuration with restart interlock | Reset button pressed. Safety output in the ON state. |
|  | Configuration with automated restart after a time | Protective field is clear, configured time to restart expires. |
|  | Configuration with at least one warning field | Warning field interrupted (left column: number of interrupted warning fields, right column: number of warning fields in the current monitoring case). |
|  | All devices and configurations | Error. All safety outputs in the OFF state. |
| Display flashes | | |
|  | All devices and configurations | Contamination warning. ▶ Check the optics cover for damage. ▶ Clean the optics cover. |
| Display flashes | | |

| Display | Device or configuration | Meaning |
|--|---|---|
|  <p>Display flashes</p> | All devices and configurations | <p>Contamination error. All safety outputs in the OFF state.</p> <ul style="list-style-type: none"> ▶ Check the optics cover for damage. ▶ Clean the optics cover. |
|  <p>Display flashes</p> | All devices and configurations | Dazzle warning. Check whether the safety laser scanner is being dazzled by an external light source in the scan plane, e.g., sun, halogen light, infrared light source. Remove or cover the light source. |
|  <p>Display flashes</p> | All devices and configurations | Dazzle error. The associated safety outputs are in the OFF state. Check whether the safety laser scanner is being dazzled by an external light source in the scan plane, e.g., sun, halogen light, infrared light source. Remove or cover the light source. |
|  <p>Display flashes</p> | Configuration with external device monitoring (EDM) | Error in the external device monitoring (EDM). OSSD pair in OFF state. |
|  <p>Display flashes</p> | Configuration with reference contour field | Manipulation protection. The safety laser scanner does not detect any contour within the configured tolerance band of the reference contour field. All safety outputs in the OFF state. |
|  <p>Display flashes</p> | All devices and configurations | Manipulation protection. The safety laser scanner measures no values within the distance measurement range in an area of at least 90°. All safety outputs in the OFF state. |
|  | All devices and configurations | Safety function stopped. All safety outputs in the OFF state. Restart the device using the keypad or Safety Designer. |
|  | All devices and configurations | <p>A valid input signal is not yet applied at the control inputs. All safety outputs in the OFF state.</p> <p>After switching on, the safety laser scanner waits for a valid input signal. During this time, an invalid input signal does not result in an error.</p> |
|  | All devices | The device is not configured. The device is in the as-delivered state or has been reset to factory settings. All safety outputs in the OFF state. |

| Display | Device or configuration | Meaning |
|---|--------------------------------|--|
|  | All devices and configurations | Passive state. All safety outputs in the OFF state. Press the button to obtain more information. |

10 Maintenance

10.1 Safety



DANGER

Improper work on the product

A modified product may not offer the expected protection if it is integrated incorrectly.

- ▶ Apart from the procedures described in this document, do not repair, open, manipulate or otherwise modify the product.
-

10.2 Regular cleaning

Overview

Depending on the ambient conditions, the optical cover must be cleaned regularly and in the event of contamination. For example, static charges can cause dust particles to be attracted to the optical cover.

Important information



WARNING

Contamination or damage to the optics cover

If the optical properties of the optics cover are impaired, persons or body parts might not be detected or not detected in time.

- ▶ Remove any contamination (e.g., droplets, condensation, frost, ice formation). Restart the safety laser scanner.
 - ▶ Replace damaged optics covers.
 - ▶ Keep the optics cover free of substances containing oil and grease.
-



NOTICE

- ▶ Do not use aggressive or abrasive cleaning agents.
 - ▶ Recommendation: Use anti-static cleaning agents.
 - ▶ Recommendation: Use anti-static plastic cleaners and lens cloths from SICK.
-

Procedure

Cleaning the optics cover

1. Make sure that the dangerous state of the machine is and remains switched off during the cleaning.
2. Remove dust from the optics cover using a soft, clean brush.
3. Moisten a clean, soft towel with anti-static plastic cleaner and use it to wipe the optics cover.
4. Check the effectiveness of the protective device.

Complementary information

If the display shows a contamination warning, the optics cover is dirty and must be cleaned soon.

If the display shows a contamination error, the optics cover is very dirty and the safety laser scanner has switched to the OFF state for safety reasons.

Further topics

- ["Thorough check of the principal function of the protective device", page 50](#)

10.3 Replacing the optics cover

Overview

If the optics cover is scratched or damaged, it must be replaced.

Important information



WARNING

Incorrect reference value of optical properties

If optics cover calibration is not done correctly, persons and parts of the body to be protected may not be detected.

- ▶ Carry out an optics cover calibration with the Safety Designer every time the optics cover is replaced.
 - ▶ Carry out the optics cover calibration at room temperature (10 °C to 30 °C).
 - ▶ Only carry out the optics cover calibration using a new optics cover.
 - ▶ Before the optics cover calibration switch on the device for a few minutes to warm up the internal components.
 - ▶ Make sure that the entire system is clear of contamination when the adjustment is carried out.
-



NOTICE

- ▶ The optics cover of the safety laser scanner is an optical component. Make sure that the optics cover does not become dirty or scratched during unpacking and mounting. Prevent fingerprints on the optics cover. Wear the gloves supplied with the new optics cover during replacement.
 - ▶ Replace the optics cover in a dry environment free of dust and dirt.
 - ▶ Never replace the optics cover during continuous operation, as dust particles could penetrate into the safety laser scanner.
 - ▶ Avoid soiling the inside of the optics cover, e.g. by fingerprints.
 - ▶ Do not use any additional sealant, such as silicone, for sealing the optics cover. Any vapors that are created may damage the optical components.
 - ▶ Mount the optics cover according to the following instructions to ensure IP65 leak tightness of the housing.
 - ▶ Only use a new optics cover as a replacement.
 - ▶ Provide ESD protection when replacing the optics cover.
-



NOTICE

Enclosure rating IP65 only applies if the optics cover and the system plug are mounted and the USB connection is closed with the protective cover.

Prerequisites

Tool required:

- TX10 key

Procedure

Figure 50: Fixing screws for the optics cover

① Fixing screw

Replacing the optical cover

1. First, clean the safety laser scanner from the outside so that no foreign bodies penetrate into the open device.
2. Unscrew the fixing screws for the optical cover.
3. Slowly and carefully detach the optics cover from the safety laser scanner. If the seal of the optics cover sticks to the safety laser scanner, carefully detach the optics cover using a screwdriver.
4. If necessary, remove contamination from the sealing groove and the bearing surface of the safety laser scanner. Use residue-free plastic cleaners.
5. Check whether the mirror is contaminated. Remove any contamination with an optic brush.
6. If you cannot remove the contamination with the optic brush, contact your local SICK subsidiary.
7. During the following steps, wear the gloves supplied with the new optical cover.
8. Take the new optics cover out of the packaging and remove the residual packaging.
9. If the seal has come loose, place the seal in the slot provided in the optics cover.
10. Carefully push the optical cover over the mirror. Make sure that the optical cover does not touch the mirror.
11. Place the optics cover onto the safety laser scanner. Make sure that the optics cover rests over the whole area.
12. Screw on the optics cover with the new fixing screws. For tightening torque, see mounting instructions of the optics cover.
13. Make sure that the optical cover is clear of dirt and damage.

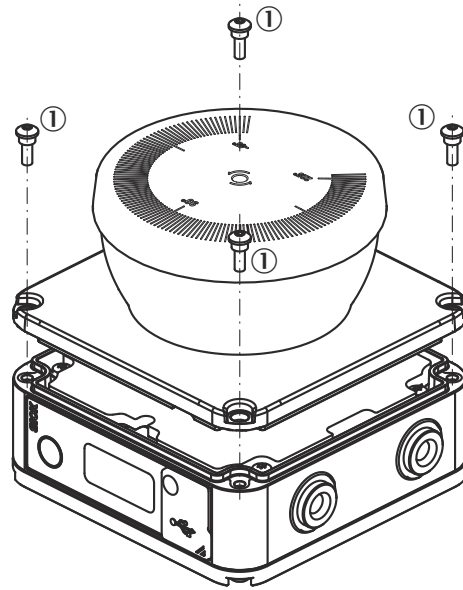
Putting the safety laser scanner back into operation

1. Properly remount the safety laser scanner.
2. Reconnect all electrical connections to the safety laser scanner.
3. Carry out optics cover calibration.
4. Start the safety function using the Safety Designer.

5. Check the effectiveness of the protective device.
 - Generally, the protective device is checked exactly as during commissioning.
 - If, during project planning, the possible tolerances of the devices have been considered and it is ensured that the configuration, wiring, or alignment of the safety laser scanner have not been changed, a function check-out is sufficient.

Further topics

- ["Spare parts", page 133](#)
- ["Mounting the device", page 54](#)
- ["Optics cover calibration", page 97](#)

10.4 Replacing the safety laser scanner

Important information



DANGER

Hazard due to lack of effectiveness of the protective device

If an unsuitable configuration is saved in the system plug, it may cause the dangerous state to not end in time.

- ▶ After replacement, make sure the same system plug is used or the configuration is restored.
- ▶ Make sure that the safety laser scanner is aligned correctly after the replacement.



NOTICE

Enclosure rating IP65 only applies if the optics cover and the system plug are mounted and the USB connection is closed with the protective cover.



NOTICE

If the system plug is mounted with excessive force, the contacts can break or bend.

- ▶ Plug in the system plug carefully.
- ▶ Do not force it.

10.4.1 Replacing the safety laser scanner without system plug

Overview



In many cases, you can reuse the existing bracket and the existing system plug. When the new safety laser scanner is switched on for the first time, it reads the configuration from the system plug and can be used without having to be reconfigured.

Prerequisites

Tool required:

- TX10 key

Procedure

1. Make sure that the environment is clean and clear of fog, moisture, and dust.
2. Unscrew the fixing screws and remove the defective safety laser scanner.
3. Unscrew screws in the system plug and remove the system plug from the defective safety laser scanner.

4. Mount the system plug on the new safety laser scanner.
5. Mount the new safety laser scanner.
6. Check the effectiveness of the protective device.
 - Generally, the protective device is checked exactly as during commissioning.
 - If during the project planning the possible tolerances of the devices have been considered and it is ensured that the configuration, wiring, or alignment of the safety laser scanner have not been changed, a function check-out is sufficient.

Complementary information

In certain cases (in the event of dust, high air humidity), it may make sense not to disconnect the system plug and the safety laser scanner at first:

1. Disconnect the connecting cables to the system plug.
2. Unscrew screws from the bracket and remove the defective safety laser scanner from the bracket.
3. Move the safety laser scanner with the system plug to a clean location (e.g. office, maintenance areas).
4. Unscrew screws in the system plug and remove the system plug from the defective safety laser scanner.
5. See above for further steps.

Further topics

- ["Replacing the system plug", page 110](#)
- ["Mounting the device", page 54](#)

10.4.2 Replacing the safety laser scanner with system plug



Procedure

1. Disconnect the connecting cables to the system plug.
2. Unscrew the fixing screws and remove the defective safety laser scanner.
3. Mount the new safety laser scanner.
4. Reconnect the connecting cables to the system plug.
5. Configure the safety laser scanner.
6. Perform commissioning again, taking particular care to conduct all of the thorough checks described.

Further topics

- ["Mounting the device", page 54](#)

10.5 Replacing the system plug



Important information



NOTICE

Enclosure rating IP65 only applies if the optics cover and the system plug are mounted and the USB connection is closed with the protective cover.

**NOTICE**

If the system plug is mounted with excessive force, the contacts can break or bend.

- ▶ Plug in the system plug carefully.
- ▶ Do not force it.

Prerequisites**Tool required:**

- TX10 key

Procedure

1. Make sure that the environment is clean and clear of fog, moisture, and dust.
2. Disconnect the connecting cables to the system plug.
3. Unscrew the screws in the defective system plug and remove the system plug from the safety laser scanner.
4. Make sure that the seal is seated correctly.
5. Carefully push the new system plug into the safety laser scanner.
6. Screw in the system plug using the captive screws. Tightening torque: 1.3 Nm.
7. Reconnect the connecting cables to the system plug.
8. Configure the safety laser scanner.
9. Perform commissioning again, taking particular care to conduct all of the thorough checks described.

Further topics

- ["Mounting the device", page 54](#)

10.6 Regular thorough check

The thorough check is intended to ensure that the safety functions are fulfilling their planned purpose and whether persons are being adequately protected.

- ▶ Carry out the checks specified in the test plan of the manufacturer of the machine and the operating entity.

11 Troubleshooting

11.1 Safety



DANGER

Improper work on the product

A modified product may not offer the expected protection if it is integrated incorrectly.

- ▶ Apart from the procedures described in this document, do not repair, open, manipulate or otherwise modify the product.



DANGER

Hazard due to unexpected starting of the machine

- ▶ When any work is taking place, use the protective device to secure the machine or to ensure that the machine is not switched on unintentionally.



NOTE

Additional information on troubleshooting can be found at the responsible SICK subsidiary.

Further topics

- ["Status indicators", page 101](#)
- ["Status indicator with the display", page 102](#)

11.2 Detailed diagnostics using the display

Overview

Use the button to call up the menu.

The menu provides access to the following areas:

- **Hardware**
- **Configuration**
- **Service interfaces**
- **Data output**
- **Service**
- **Device restart**

Procedure

- ▶ Press and hold to call up the menu.
- ▶ Press the button briefly to switch to the desired menu item.
- ▶ Press and hold the button to confirm the desired menu item.
- ▶ Press the button briefly to navigate through the selected submenu.
- ▶ Press the button repeatedly and briefly to return to the main menu.
- ▶ Do not press the button for some time so that the display returns to the status display.

Complementary information

The display language is set using Safety Designer during configuration. The display language and the configuration cannot be changed using the button on the display.

11.3 Error indication on the display

Overview

If there is an error, the display shows a warning symbol, a type of error and an error code on a red flashing background.

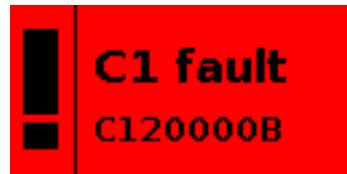

Figure 51: Error indication

- The two-character error type will help you during troubleshooting.
- The eight-character error code in the bottom line helps SICK support during the detailed error analysis.
- Pressing the button briefly shows you more information about the error for troubleshooting.
- You will find detailed information in Safety Designer's message history about the individual errors and information about events not shown by the display.

Error indication on the display

Table 27: Error types (selection)

| Error type | Brief description | Cause | Troubleshooting |
|------------|---|---|---|
| C1 | Faulty configuration | The configuration is faulty. | ▶ Reconfigure the device. |
| C2 | Incompatible configuration | The configuration in the system plug does not match the device's functionality. | ▶ Check device variant. ▶ Replace or reconfigure the device. |
| C3 | Incompatible firmware | The configuration in the system plug does not match the device's firmware version. | ▶ Check the firmware version of the device. ▶ Replace or reconfigure the device. |
| D1 | Speed tolerance exceeded | The deviation between the measured speeds of the two incremental encoders has exceeded the tolerance permitted for the current travel situation for longer than permissible. | ▶ Check the configuration with Safety Designer. ▶ Check the working process of the machine. ▶ Check speed source. |
| D2 | Direction of rotation different | The direction of rotation output by the incremental encoders is different. The allowed tolerance time has been exceeded. | ▶ Check the configuration with Safety Designer. ▶ Check the working process of the machine. ▶ Check speed source. |
| D3 | Wiring error at dynamic control inputs | <ul style="list-style-type: none"> • Cross-circuit between 0° and 90° • Cross-circuit between incremental encoder 1 and incremental encoder 2 • Connection cable of the incremental encoders not correctly connected | ▶ Check wiring. |
| D4 | Maximum speed or input frequency exceeded | The maximum speed or the maximum input frequency (pulses per second) was exceeded at a dynamic control input. | ▶ Check the configuration with Safety Designer. ▶ Check the working process of the machine. ▶ Check speed source. |

| Error type | Brief description | Cause | Troubleshooting |
|------------|---|---|---|
| D5 | Speed limit exceeded | The speed is outside the configured speed range. The signal is applied for longer than 1 s. | <ul style="list-style-type: none"> ▶ Check the configuration with Safety Designer. ▶ Check the working process of the machine. ▶ Check speed source. |
| E1 | Error in the safety laser scanner | The safety laser scanner has an internal error. | <ul style="list-style-type: none"> ▶ Perform a device restart using the display or Safety Designer or interrupt the voltage supply for at least two seconds. ▶ Replace the safety laser scanner and send it to the manufacturer for repair. |
| E2 | Error in the safety laser scanner | The safety laser scanner has an internal error. | <ul style="list-style-type: none"> ▶ Perform a device restart using the display or Safety Designer or interrupt the voltage supply for at least two seconds. ▶ Replace the safety laser scanner and send it to the manufacturer for repair. |
| E3 | Error in the system plug | The system plug has an internal error. | <ul style="list-style-type: none"> ▶ Perform a device restart using the display or Safety Designer or interrupt the voltage supply for at least two seconds. ▶ Replace the system plug. |
| E4 | Incompatible system plug | The system plug is unsuitable for the safety laser scanner. | <ul style="list-style-type: none"> ▶ Check part number or type code. ▶ Replace the system plug. |
| E5 | Dazzle error | Strong external light source, e.g., sun, halogen headlamps, infrared light source, stroboscope. | <ul style="list-style-type: none"> ▶ Remove or cover the light source. ▶ Perform a device restart using the display or Safety Designer or interrupt the voltage supply for at least two seconds. |
| F1 | Current too high at an OSSD | The current is too high at an OSSD. The limit has been exceeded for current allowed short-term or permanently. | <ul style="list-style-type: none"> ▶ Check connected switching element. |
| F2 | OSSD short-circuit to 24 V | There is a short-circuit to 24 V at an OSSD. | <ul style="list-style-type: none"> ▶ Check wiring. |
| F3 | OSSD short-circuit to 0 V | There is a short-circuit to 0 V at an OSSD. | <ul style="list-style-type: none"> ▶ Check wiring. |
| F4 | Short-circuit between 2 OSSDs | There is a short-circuit between 2 OSSDs. | <ul style="list-style-type: none"> ▶ Check wiring. |
| F5 | Short-circuit between OSSD and universal input or universal I/O | There is a short-circuit between an OSSD and a universal input or between an OSSD and a universal I/O. | <ul style="list-style-type: none"> ▶ Check wiring. |
| F9 | General OSSD error | At least one OSSD is showing unexpected behavior. | <ul style="list-style-type: none"> ▶ Check the wiring of the OSSDs. |
| L2 | Invalid configuration of the external device monitoring (EDM) | The configuration of the external device monitoring (EDM) is invalid. The configuration is unsuitable for the wiring. | <ul style="list-style-type: none"> ▶ Check whether the external device monitoring is connected correctly. ▶ Check the configuration with Safety Designer. |
| L3 | Error in the external device monitoring (EDM) | A faulty signal is applied at the external device monitoring (EDM). The allowed tolerance time has been exceeded. | <ul style="list-style-type: none"> ▶ Check whether the contactors are wired correctly and operating correctly. |

| Error type | Brief description | Cause | Troubleshooting |
|------------|---|--|---|
| L8 | Error in the reset input | An invalid signal is applied at a reset input. The reset signal is applied for too long. | ▶ Check the reset pushbutton, the wiring, and any other components affected. |
| L9 | Short-circuit at the reset input | Exactly the same signal is applied at a reset input as at another input, an OSSD or an output. There may be a short-circuit. | ▶ Check wiring for cross-connections. |
| M1 | Incompatible configuration of the data output | The data output is configured in a way that the device does not support (e.g., invalid start angle). | ▶ Reconfigure the data output. |
| M2 | Data output: Data packets lost | The data output could not transmit all data packets (for example, buffer memory full). | ▶ Configure the data output so that less data is transmitted. |
| M3 | Configuration not verified | The configuration is not verified. | ▶ Verify the configuration. |
| N1 | Invalid input signal | The signal applied at the control inputs is not assigned to a monitoring case. The signal is applied for longer than the set input delay +1 s. | ▶ Check the configuration with Safety Designer. ▶ Check the working process of the machine. |
| N2 | Incorrect switching sequence | The configured switching sequence was interrupted by the new monitoring case. | ▶ Check the working process of the machine. ▶ Change configured switching order. |
| N3 | Invalid input signal | The signal applied at the static control inputs does not match the complementary condition. The signal is applied for longer than 1 s. | ▶ Check activation of the control inputs. |
| T1 | Temperature error | The operating temperature of the safety laser scanner has exceeded or fallen below the permitted range. | ▶ Check whether the safety laser scanner is being operated in accordance with the permissible ambient conditions. |
| W1 | Warnings exceed tolerance time | The combination of multiple warnings has resulted in an error. The tolerance time of 1 s has been exceeded as there are multiple warnings. | ▶ Use Safety Designer to check what warnings exist. |

11.4 Diagnostics using Safety Designer

Diagnostic tools

The following diagnostics tools are available in the device window:

- Data recorder
- Event history
- Message history

Interfaces

The following interfaces are suitable for diagnostics:

- USB ⁵⁾
- Ethernet

⁵⁾ The USB connection may only be used temporarily and only for configuration and diagnostics.

11.4.1 Data recorder

Overview

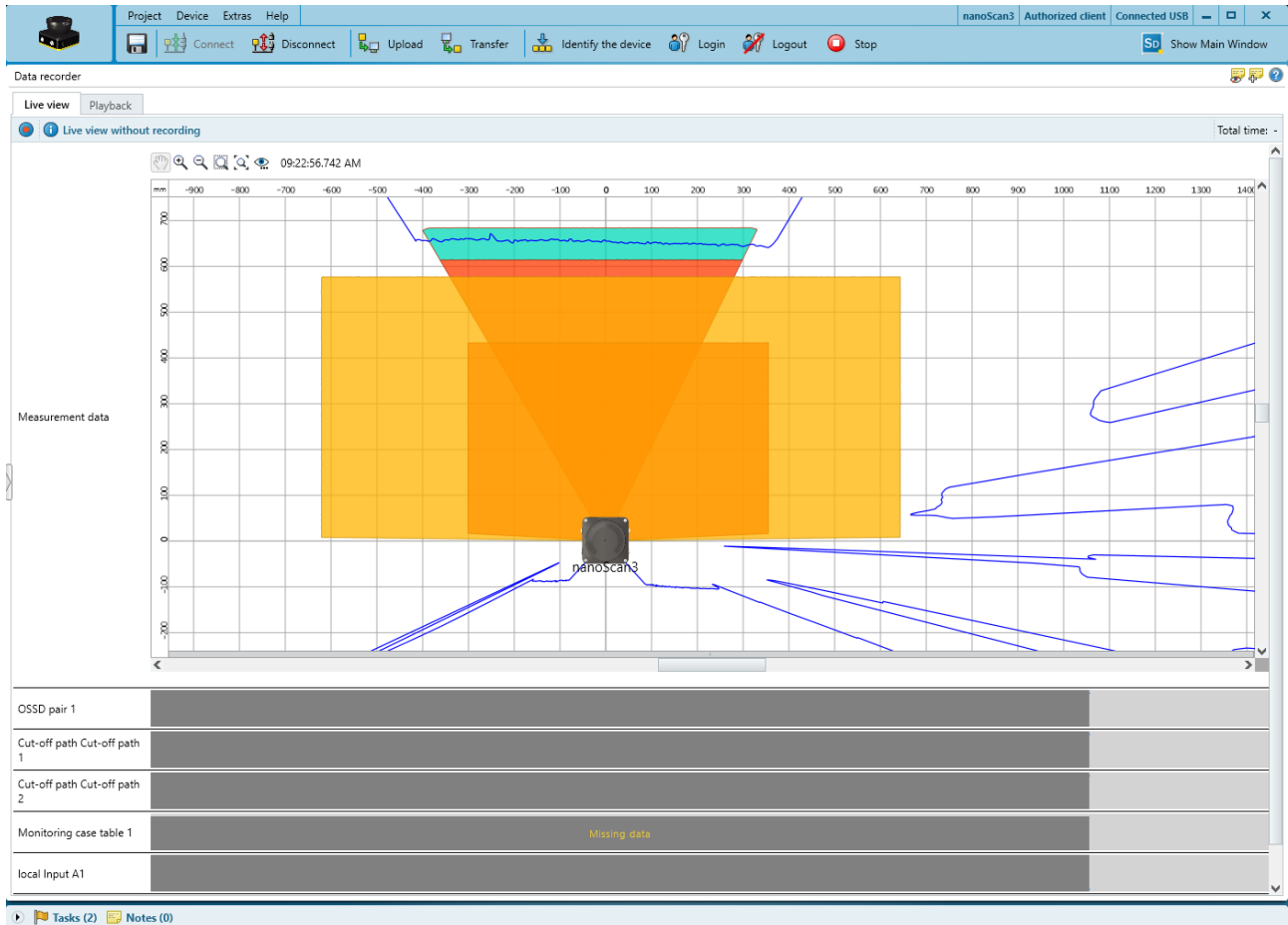

Figure 52: Data recorder

You can use the data recorder to record the device's signals. Depending on the interface and the load on the interface, the measurement data may not be transmitted and shown for every scan cycle.

The data is saved in a data recorder diagnostics file.

You can play the data recorder diagnostic file in the data recorder.

You can adjust the settings in the Safety Designer main window.

Table 28: Data recorder

| | |
|--|------------------|
| | Start recording |
| | Stop recording |
| | Full screen mode |

Prerequisites

- Existing connection between Safety Designer and device
- Configuration in the project and configuration in the device are synchronized.

Typical applications

- Check spatial geometry
- Check where a person can stay or when a person is detected
- Check input information about the current monitoring case
- Check why safety outputs have switched

11.4.2 Event history

Overview

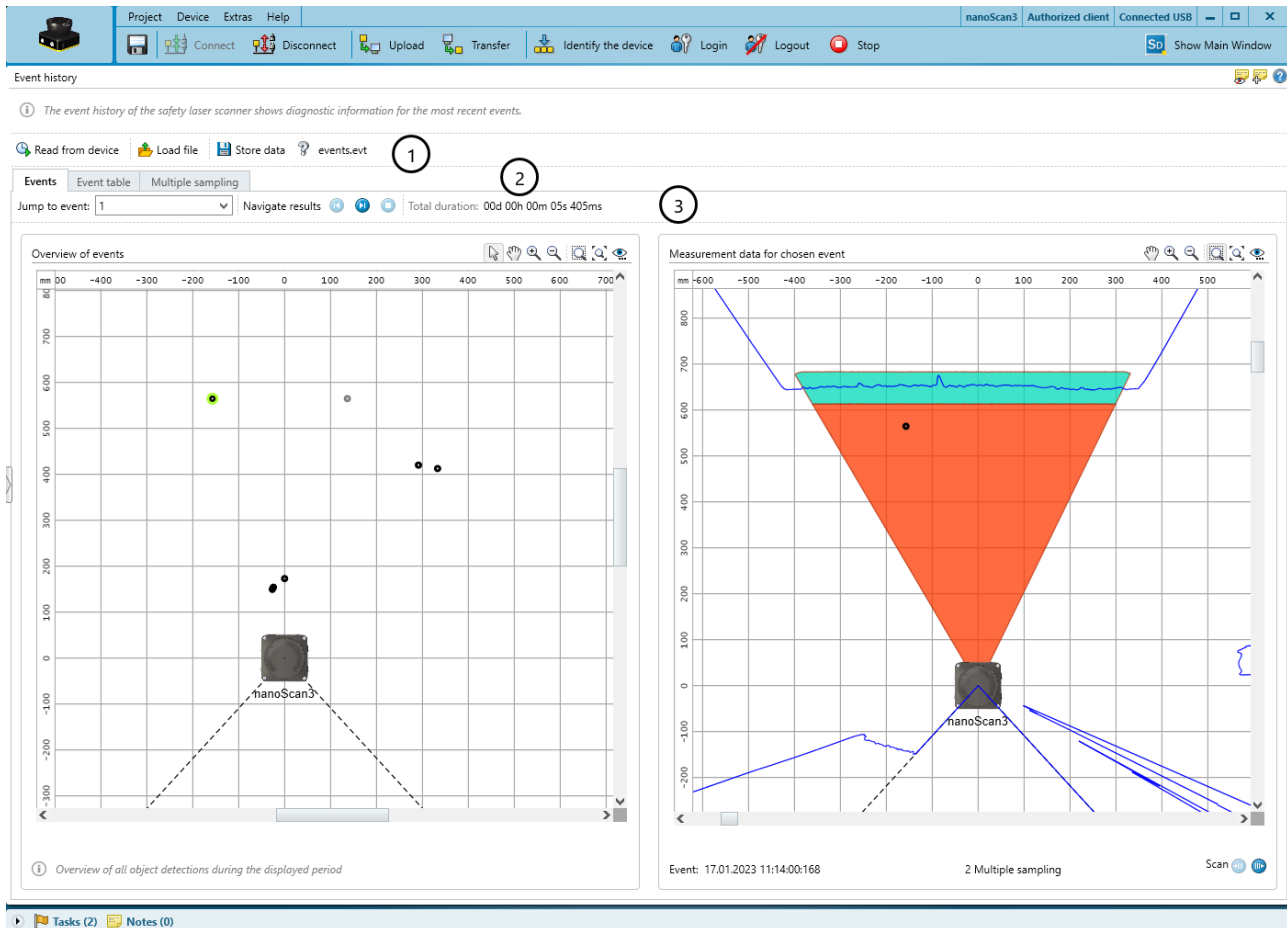

Figure 53: Event history

- ① Data source
- ② Available views
- ③ Navigation

The safety laser scanner stores data on important events. The event history displays information about the most recently stored events.

Event memory in the safety laser scanner

The safety laser scanner stores data on the following events:

- Safety output switches to the OFF state.
- An object is detected in a safety-related field.

For each object detection where a safety output switches to the OFF state, the safety laser scanner stores the data from 10 scans. When the internal memory of the safety laser scanner is full, the scan data of the oldest object detection is overwritten to store a new object detection. The position and time of the object detection are retained.

The internal memory of the safety laser scanner is cleared during a restart and when transferring a configuration.

Data source

- **Read from device:** Only available when a device is connected. The data stored in the device will be read.
- **Load file:** You can open a file that stores events that were previously read from a device.
- **Store data:** You can save the events read from a device to a file for later analysis.

Events

The **Events** view shows a graphical overview of the object detections in safety-related fields that have led to a safety output switching to the OFF state.

- **Navigation:** You can select the event whose measurement data is displayed in the right area.
- **Overview of events:** The position of each recorded object detection relative to the safety laser scanner is displayed. If you hold the mouse pointer on a position, the set multiple sampling is displayed. When you click on a position, the corresponding measurement data is displayed in the right-hand area.
- **Measurement data for the selected event:** The measurement data of the selected object detection is displayed. If multiple scans are stored for the selected object detection, you can view the individual scans one by one by clicking on the icons next to **Scan**.

Event table

The event table shows detailed information about the events which have led to a safety output switching to the OFF state.

Based on the measurement data, a probable cause is assigned to each event:

- **Object:** An object was probably detected in the protective field.
- **Contour:** A reference contour field or a contour identification field detects a deviation of the monitored contour.
- **Contamination:** The shutdown was triggered by a contamination of the optics cover in the area of the protective field. The displayed distance relates to an object that was detected despite the contamination. This value is not reliable due to the contamination.
- **Glare:** The shutdown was triggered by an external light source in the scan plane in the area of the protective field, e.g., sun, halogen light, infrared light source, stroboscope.
- **Close to field edge or particle in field:** Object detection in the protective field was probably triggered at the edge or by particles.

Multiple sampling

The **Multiple sampling** view shows how often object detections with different durations occurred. All object detections in safety-related fields are taken into account. Therefore, the number of entries in this view may deviate from the other views.

The duration is specified as the number of consecutive scans in which an object is detected in the field. For each duration, the diagram shows the corresponding number of object detections.

11.4.3 Message history

Overview

The screenshot shows the Message History window in nanoScan3. The main table displays the following messages:

| Type | Occurrence | End | Message | Acknowledged |
|-------------|----------------------|----------------------|------------------------------------|--------------|
| Warning | 1/24/2023 2:38:39 PM | - | Reference contour field infringed. | |
| Information | 1/24/2023 2:38:39 PM | - | Monitoring case switching | |
| Information | 1/24/2023 2:38:35 PM | 1/24/2023 2:38:36 PM | Device started in test mode | |
| Information | 1/24/2023 2:37:49 PM | 1/24/2023 2:37:50 PM | Device started in test mode | |
| Error | 1/24/2023 2:32:44 PM | - | C1 - Faulty configuration | |

The details for the selected warning message are as follows:

| | |
|-----------------------|---|
| Code | 0x63041006 |
| Local time occurrence | 20547/0 days 0 h 5 min 29 s 119 ms |
| Reason | Manipulation detection. An intrusion of the monitoring reference contour field has been detected. |
| Solution: | Check mounting orientation of device. |
| Info 1 | 0 |
| Info 2 | 0 |
| Info 3 | 0 |
| Info 4 | 0 |

The Settings panel on the right shows the following filters:

- Messages:
 - Warning
 - Error
 - Info
 - Event
- Time:
 - Outstanding
 - Selective
 - End
- Acknowledgment:
 - Acknowledgment
 - Unknown

Buttons: Reset all filters

Figure 54: Message history



- ① Message history
- ② Display filter
- ③ Details about the selected message

Events such as errors, warnings and information are stored in the message history.

By right-clicking on the table header, you can select the columns displayed in the message history.

Safety Designer shows details about the events in the bottom part of the window, ways to solve them are also shown.

Table 29: Print or export message history

| | |
|---|-------------------------------|
|  | Print message history |
|  | Save message history as a PDF |
|  | Save message history as CSV |

12 Decommissioning

12.1 Disposal

Procedure

- ▶ Always dispose of unusable devices in accordance with national waste disposal regulations.



Complementary information

SICK will be glad to help you dispose of these devices on request.

13 Technical data

13.1 Version numbers and functional scope

Functional scope

Older devices might not support the full functional scope of the latest Safety Designer. To identify the different levels of the functionality, we use a three-digit version number.

The functional scope of the device is at the following locations:

- Type label, Version field
- Display, entry in the **Hardware** menu
- Safety Designer, **Overview** dialog box (only with connected device)
- Safety Designer, report

Table 30: Functional scope

| Type code | Version number | Amendments and new functions |
|-----------------|----------------|---|
| NANS3-AAAZ30AN1 | V 1.0.0 | <ul style="list-style-type: none"> • First released version |
| | V 1.1.0 | <ul style="list-style-type: none"> • Deviating multiple sampling after object detection can be configured • Interfaces and selected functions can be activated or deactivated • New Always ON (NON-safe) function in monitoring case tables |
| NANS3-CAAZ30AN1 | V 1.0.0 | <ul style="list-style-type: none"> • First released version |
| | V 1.1.0 | <ul style="list-style-type: none"> • Deviating multiple sampling after object detection can be configured • Interfaces and selected functions can be activated or deactivated • New Always ON (NON-safe) function in monitoring case tables |

Revision

To identify the different revision levels of the devices, we use a three-digit version number. The revision level of the device is indicated on the type label in the Revision field.

Table 31: Revision

| Type code | Version number | Amendments and new functions |
|-----------------|----------------|---|
| NANS3-AAAZ30AN1 | Rev 1.0.0 | <ul style="list-style-type: none"> • First released version |
| | Rev 1.1.0 | <ul style="list-style-type: none"> • Data output: Accuracy of angle specification improved |
| | Rev 1.2.0 | <ul style="list-style-type: none"> • Transmission of the measurement data to Safety Designer optimized, improved live display of the spatial contour |
| | Rev 1.3.0 | <ul style="list-style-type: none"> • Adaptation of detection behavior for optimized safety and availability |

| Type code | Version number | Amendments and new functions |
|-----------------|----------------|--|
| NANS3-CAAZ30AN1 | Rev 1.0.0 | <ul style="list-style-type: none"> First released version |
| | Rev 1.1.0 | <ul style="list-style-type: none"> Data output: Accuracy of angle specification improved |
| | Rev 1.2.0 | <ul style="list-style-type: none"> Transmission of the measurement data to Safety Designer optimized, improved live display of the spatial contour Encoder evaluation: General stability improvement |
| | Rev 1.3.0 | <ul style="list-style-type: none"> Adaptation of detection behavior for optimized safety and availability |

13.2 Data sheet

Table 32: Features

| | nanoScan3 Core I/O | nanoScan3 Pro I/O |
|---|--|-------------------|
| Protective field range | ≤ 3.0 m, details: see "Sensing range", page 128 | |
| Scanning range of the reference contour field | Like protective field range, see "Sensing range", page 128 | |
| Scanning range of the contour detection field | Like protective field range, see "Sensing range", page 128 | |
| Warning field range | ≤ 10 m | |
| Distance measurement range | ≤ 40 m | |
| Fields | ≤ 8 | ≤ 128 |
| Simultaneously monitored fields | ≤ 4 | ≤ 8 |
| Field sets | ≤ 8 | ≤ 128 |
| Monitoring case tables | 1 | 2 |
| Monitoring cases | ≤ 2 | ≤ 128 |
| Scanning angle | 275° (-47.5° to 227.5°) | |
| Protective field resolution | 20 mm, 30 mm, 40 mm, 50 mm, 60 mm, 70 mm, 150 mm, 200 mm | |
| Angular resolution | 0.17° | |
| Response time | ≥ 70 ms, details: see "Response times", page 127 | |
| Scan cycle time | 30 ms | |
| Generally necessary protective field supplement (TZ = tolerance zone of the safety laser scanner) | 65 mm | |
| Additional supplement Z_R for reflection-based measurement errors | 350 mm | |
| Deviation from ideal flatness of scan field at 3 m | ≤ ± 75 mm | |
| Multiple sampling | 2 ... 16 | |

Table 33: Safety-related parameters

| | nanoScan3 Core I/O | nanoScan3 Pro I/O |
|------------------------|--------------------|-------------------|
| Type | Type 3 (IEC 61496) | |
| Safety integrity level | SIL 2 (IEC 61508) | |

| | nanoScan3 Core I/O | nanoScan3 Pro I/O |
|---|--|-------------------|
| SIL claim limit | SILCL 2 (IEC 62061) | |
| Category | Category 3 (ISO 13849-1) | |
| Performance level | PL d (ISO 13849-1) | |
| PFH_D (mean probability of a dangerous failure per hour) | 8×10^{-8} | |
| T_M (mission time) | 20 years (ISO 13849-1) | |
| Safe status when an error occurs | At least one OSSD is in the OFF state. | |

Table 34: Interfaces

| | nanoScan3 Core I/O | nanoScan3 Pro I/O |
|---|---|--------------------------|
| OSSD pairs | 1 | ≤ 2 |
| Automated restart of OSSDs after | 2 s to 60 s (configurable) | |
| Length of cable | ≤ 30 m | ≤ 20 m |
| USB | | |
| Connection type | USB 2.0 Micro-B (female connector) | |
| Transmission rate | ≤ 12 Mbit/s (Full Speed) | ≤ 12 Mbit/s (Full Speed) |
| Length of cable | ≤ 3 m | |
| Ethernet ¹⁾ | | |
| Connection type | M12 female connector, 4-pin, D-coded | |
| Port properties | <ul style="list-style-type: none"> • 100BASE-TX • Auto-negotiation • Auto-crossover (MDIX) • Auto-polarity | |
| Transmission rate | ≤ 100 Mbit/s | |
| Length of cable | ≤ 100 m | |
| Services | <ul style="list-style-type: none"> • Configuration and diagnostics using Safety Designer • Data output • SNMP (client) | |

¹⁾ The network connection is available for certain system plugs.

Table 35: Electrical data

| | nanoScan3 Core I/O | nanoScan3 Pro I/O |
|-------------------------------|---|-------------------|
| Operating data | | |
| Protection class | III (IEC 61140) | |
| Supply voltage V _S | 24 V DC (16.8 V to 30 V DC) (SELV/PELV) ¹⁾ | |
| Residual ripple | ± 5% ²⁾ | |
| Start-up current at 24 V | ≤ 1.3 A | |
| Current consumption at 24 V | | |
| No output load | Typ. 0.16 A | |
| With maximum output load | Typ. 0.66 A | |
| Sleep mode | Typ. 0.13 A | |
| Power consumption | | |
| No output load | Typ. 3.9 W | |
| With maximum output load | Typ. 15.9 W | |

| | nanoScan3 Core I/O | nanoScan3 Pro I/O |
|---|---|---|
| Sleep mode | Typ. 3.2 W | |
| Total output current | ≤ 500 mA | |
| Power-up delay | ≤ 12 s | |
| Safety outputs (OSSD) | | |
| Type of output | 2 PNP semiconductors for each OSSD pair, short-circuit protected, cross-circuit monitored | 2 PNP semiconductors for each OSSD pair, short-circuit protected, cross-circuit monitored |
| Output voltage for ON state (HIGH) | $(U_V - 2 V) \dots U_V$ | $(U_V - 2 V) \dots U_V$ |
| Output voltage for OFF state (LOW) | 0 V ... 2 V | |
| Output current for ON state (HIGH) | 0.5 mA ... 250 mA per OSSD ³⁾ | |
| Leakage current | ≤ 250 μA | |
| Load inductance | ≤ 2.2 H | |
| Load capacity | ≤ 1 μF in series with 50 Ω | |
| Permissible resistivity between load and device | ≤ 4 Ω | |
| Test pulse width | ≤ 300 μs (typ. 230 μs) | |
| Test pulse interval | Typ. 8 × scan cycle time | |
| Duration of OFF state | ≥ 80 ms | |
| Discrepancy time (time offset between switching OSSDs of an OSSD pair) | ≤ 10 ms | |
| Universal output, universal I/O (configured as output) | | |
| Output voltage HIGH | $(U_V - 2 V) \dots U_V$ | |
| Output voltage LOW | 0 V ... 2 V | |
| Output current HIGH | 0.5 mA ... 200 mA ³⁾ | |
| Leakage current | ≤ 250 μA | |
| Switch-on delay time | 30 ms | |
| Switch off delay | 30 ms | |
| Static control input, universal input, universal I/O (configured as input) | | |
| Input voltage HIGH | 24 V (11 V ... 30 V) | |
| Input voltage LOW | 0 V (-30 V ... 5 V) | |
| Input current HIGH | 2 mA ... 3 mA | |
| Input current LOW | 0 mA ... 2 mA | |
| Input capacitance | Typ. 10 nF | |
| Input frequency (max. switching sequence when used as control input) | ≤ 20 Hz | |
| Sampling time | 4 ms | |
| Response time at EDM after switching on OSSDs (when used as EDM input) | 300 ms | |
| Actuating duration of control switch for reset (when used as reset input) | 60 ms to 30 s | |

| | nanoScan3 Core I/O | nanoScan3 Pro I/O |
|---|--------------------|------------------------------------|
| Actuating duration of switch for sleep mode (when used as sleep mode input) | ≥ 120 ms | |
| Dynamic control input | | |
| Input voltage HIGH | - | 24 V (11 V ... 30 V) |
| Input voltage LOW | - | 0 V (-30 V ... 5 V) |
| Input current HIGH | - | 2 mA ... 3 mA |
| Input current LOW | - | 0 mA ... 2 mA |
| Input capacitance | - | Typ. 1 nF |
| Input frequency | - | ≤ 100 kHz |
| Duty cycle (Ti/T) | - | 0.5 |
| Incremental encoders that can be evaluated | | |
| Type | - | Dual-channel, 90° phase separation |
| Outputs required on the incremental encoders | - | Push-pull |
| Number of pulses per path | - | ≥ 100 pulses per cm |
| Length of cable (shielded) | - | ≤ 20 m |

- 1) The supply voltage must be within the specified range at all times. It must not fall below the lower limit, even for a brief period.
The power supply unit must be able to bridge a brief power failure of 20 ms as specified in IEC 60204-1. Suitable power supply units are available as accessories from SICK.
- 2) The voltage level must not fall below the specified minimum voltage.
- 3) Total output current of all outputs ≤ 500 mA.

Table 36: Mechanical data

| | nanoScan3 Core I/O | nanoScan3 Pro I/O |
|--|---|-------------------|
| Dimensions (incl. system plug, W × H × D) | 106.6 mm × 80.2 mm × 117.5 mm | |
| Weight (including system plug) | 0.67 kg | |
| Housing material | Aluminum | |
| Housing color | RAL 9005 (black) and RAL 1021 (rape yellow) | |
| Optics cover material | Polycarbonate | |

Table 37: Ambient data

| | nanoScan3 Core I/O | nanoScan3 Pro I/O |
|--|-------------------------------------|-------------------------------------|
| Enclosure rating ¹⁾ | IP65 (IEC 60529) | |
| Ambient light immunity | ≤ 40 klx ²⁾ | |
| Ambient operating temperature | -10 °C ... 50 °C | |
| Storage temperature | -25 °C ... 70 °C | |
| Air humidity | ≤ 95%, non-condensing ³⁾ | ≤ 95%, non-condensing ⁴⁾ |
| Height above sea level during operation | ≤ 2,300 m | |
| Vibration resistance ⁵⁾ | | |

| | nanoScan3 Core I/O | nanoScan3 Pro I/O |
|---------------------------------------|---|-------------------|
| Standards | <ul style="list-style-type: none"> • IEC 60068-2-6 • IEC 60068-2-64 • IEC 60721-3-5 • IEC TR 60721-4-5 • IEC 61496-3 | |
| Class | <ul style="list-style-type: none"> • 5M1 (IEC 60721-3-5) | |
| Sinusoidal vibrations | <ul style="list-style-type: none"> • 0.35 mm, 50 m/s², 10 Hz ... 150 Hz • 1.5 mm, 1 Hz ... 9 Hz • 50 m/s², 9 Hz ... 200 Hz • 10 m/s², 10 Hz ... 1,000 Hz | |
| Noise vibrations | <ul style="list-style-type: none"> • 0.3 m²/s³, 10 Hz ... 200 Hz • 0.1 m²/s³, 200 Hz ... 500 Hz • 50 m/s², 10 Hz ... 500 Hz | |
| Shock resistance ⁵⁾ | | |
| Standards | <ul style="list-style-type: none"> • IEC 60068-2-27 • IEC 60721-3-5 • IEC TR 60721-4-5 • IEC 61496-3 | |
| Class | <ul style="list-style-type: none"> • 5M1 (IEC 60721-3-5) | |
| Single shock | 150 m/s ² , 11 ms | |
| Continuous shock | <ul style="list-style-type: none"> • 50 m/s², 11 ms • 100 m/s², 16 ms | |
| EMC | In accordance with IEC 61496-1, IEC 61000-6-2, and IEC 61000-6-3 | |

- 1) The specified enclosure rating only applies if the optics cover and the system plug are mounted and the USB connection is closed with the protective cover.
- 2) For ambient light sources directly in the scan plane in accordance with IEC 61496-3: ≤ 3 klx
- 3) IEC 61496-1, no. 4.3.1 and no. 5.4.2, IEC 61496-3, no. 4.3.1 and no. 5.4.2. Condensation has an influence on normal operation.
- 4) IEC 61496-1, no. 4.3.1 and no. 5.4.2, IEC 61496-3, no. 4.3.1 and no. 5.4.2. Condensation has an influence on normal operation.
- 5) In direct mounting.

Table 38: Miscellaneous data

| | nanoScan3 Core I/O | nanoScan3 Pro I/O |
|---|------------------------|-------------------|
| Type of light | Pulsed laser diode | |
| Wavelength | 905 nm | |
| Detectable remission | 1.8% to several 1,000% | |
| Maximum uniform contamination of the optics cover without reducing the detection capability ¹⁾ | 30% | |
| Area where detection capability is restricted | ≤ 50 mm ²⁾ | |
| Light spot size ³⁾ | | |
| At front screen | 9 mm × 3 mm | |
| At 3.0 m distance | 15 mm × 2 mm | |
| Pulse duration | Typ. 4 ns | |
| Average output power | 12.8 mW | |
| Laser class | 1 ⁴⁾ | |

| | nanoScan3 Core I/O | nanoScan3 Pro I/O |
|---------------------------------------|--------------------|-------------------|
| Measurement uncertainty ⁵⁾ | Typ. ± 25 mm | |

- 1) In the event of heavy contamination, the safety laser scanner displays a contamination error and switches all safety outputs to the OFF state.
- 2) In close proximity (50 mm-wide area in front of the optics cover), the detection capability of the safety laser scanner may be restricted. If required, this area must be secured using an undercut or frame, for example.
- 3) W × H when the laser beam exits at a 90° angle to the front.
- 4) This laser product has laser class 1 according to IEC 60825-1:2014. In some cases, evaluation is required according to the older IEC 60825-1:2007 standard, e.g. by employers in the EU according to Directive 2006/25/EC. According to the older IEC 60825-1:2007 standard, laser class 1M must be used as the basis.
- 5) Typical values at 20 °C and remission factor = 1.8%, distance = protective field range.
The measured values are less accurate for reflectors or reflective surfaces because the distance measurement is designed for lower remission values.

Complementary information

For more technical data specifically relating to the measurement data, see the technical information “microScan3, outdoorScan3, nanoScan3: Data output via UDP and TCP/IP” (part number 8022706).

13.3 Response times

Overview

The protective device’s response time is the maximum time between the occurrence of the event leading to the sensor’s response and supply of the switch-off signal to the protective device’s interface (for example OFF state of the OSSD pair).

In addition to the protective device’s response time, further signal transmission and processing also influence the time up until the end of the dangerous state. This includes a control’s processing time and the response times of downstream contactors, for example.

Response time

The safety laser scanner’s response time depends on the set multiple sampling.

You can calculate the response time using the following formula:

$$t_R = n \times 30 \text{ ms} + 10 \text{ ms}$$

The following rules apply:

- t_R = response time
- n = set multiple sampling (default: $n = 2$)

13.4 Course of the OSSD test over time

The safety laser scanner tests the OSSDs at regular intervals. To do this, the safety laser scanner switches each OSSD briefly to the OFF state and checks whether this channel is voltage-free during this time.

Make sure that the machine’s control does not react to these test pulses and the machine does not switch off.

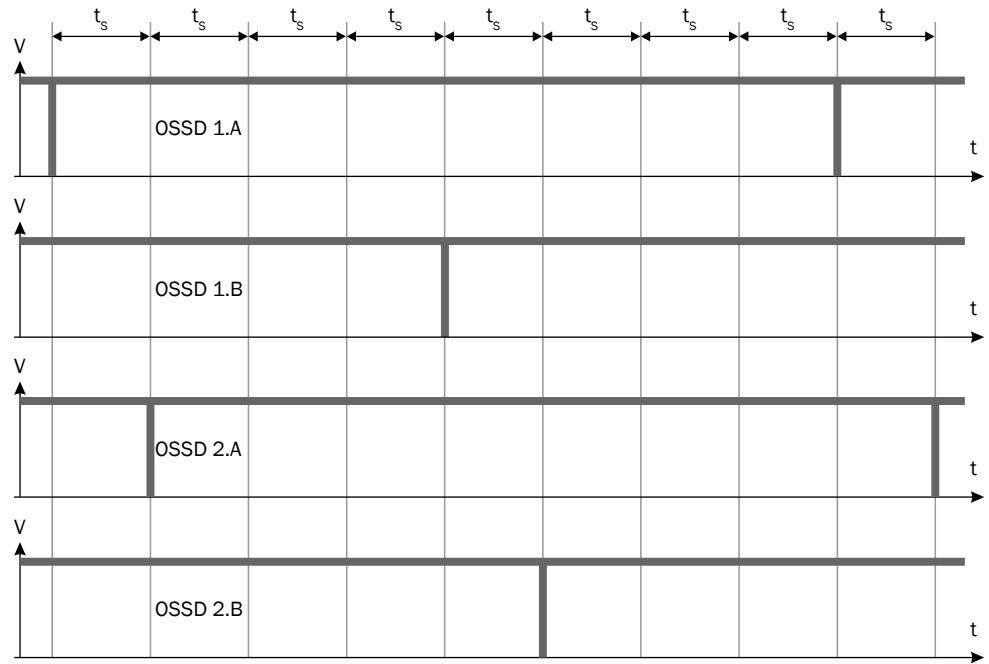

Figure 55: Switch-off tests

t_s Scan cycle time $t_s = 30$ ms

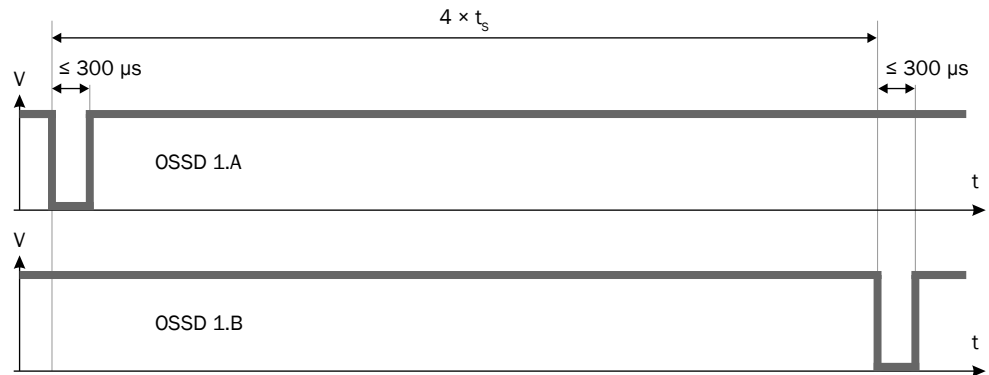

Figure 56: Duration and time offset for the switch-off tests in an OSSD pair

t_s Scan cycle time $t_s = 30$ ms

13.5 Sensing range

Protective field range

The effective protective field range depends on the object resolution that has been set.

Table 39: Protective field range

| Resolution | Protective field range |
|--------------|------------------------|
| ≥ 70 mm | 3.00 m |
| 60 mm | 2.60 m |
| 50 mm | 2.15 m |
| 40 mm | 1.60 m |
| 30 mm | 1.25 m |
| 20 mm | 1.25 m |

Scanning range of the reference contour field

The effective scanning range of the reference contour field is the same as the protective field range.

Scanning range of the contour detection field

The effective scanning range of the contour detection field is the same as the protective field range.

Warning field range and distance measurement range

For non-safety applications (warning fields, measurement data output), the safety laser scanner has a larger scanning range than the maximum protective field range. The requirements for size and remission factor of objects to be detected are illustrated in the following graphs as a function of the desired scanning range. Under good conditions, in many cases a smaller object size or a lower remission factor is sufficient to achieve the desired scanning range.

The range is limited to 10 m for warning fields.

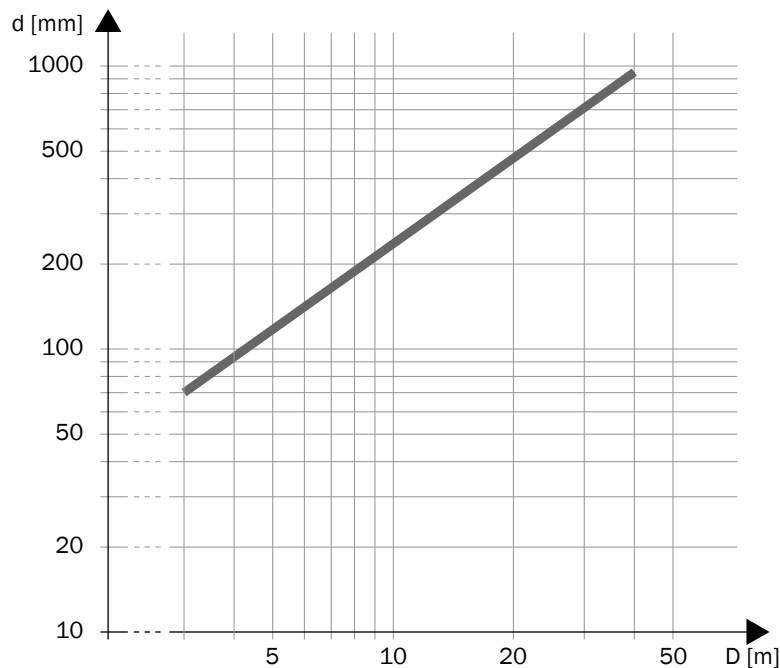

Figure 57: Range and object size for measured data output

- d** Required minimum size of the object in mm
- D** Scanning range in m

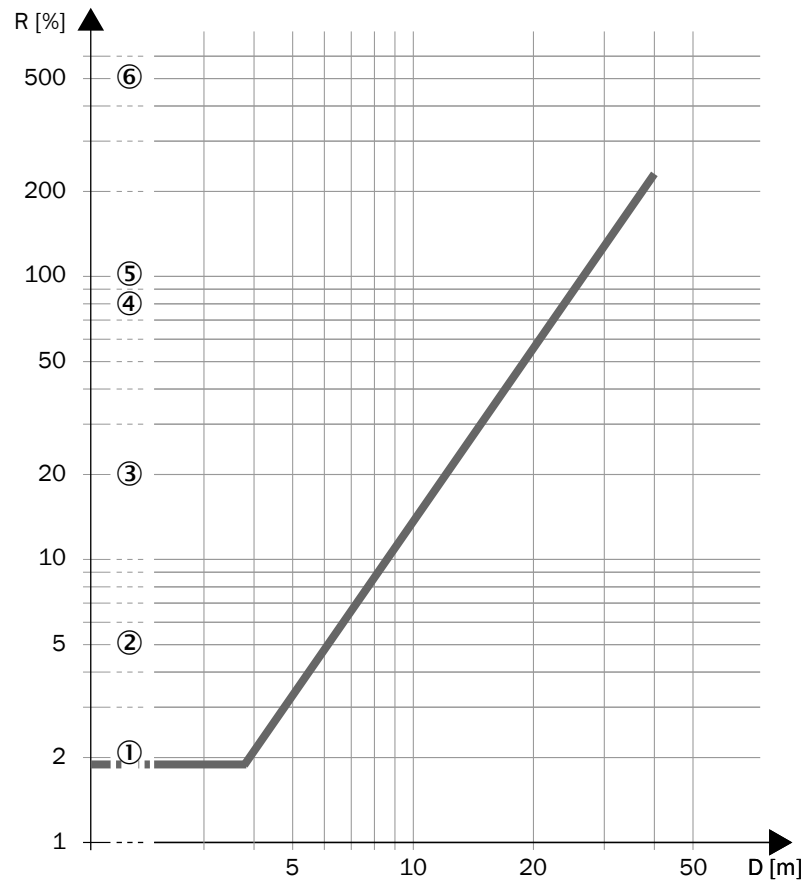

Figure 58: Range and required remission for measured data output

- R** Required minimum remission in %
- D** Scanning range in m
- ① Black shoe leather
- ② Matt black paint
- ③ Gray cardboard
- ④ Writing paper
- ⑤ White plaster
- ⑥ Reflectors > 2,000%, reflective tapes > 300%⁶⁾

⁶⁾ The measured values are less accurate for reflectors or reflective surfaces because the distance measurement is designed for lower remission values.

13.6 Dimensional drawings

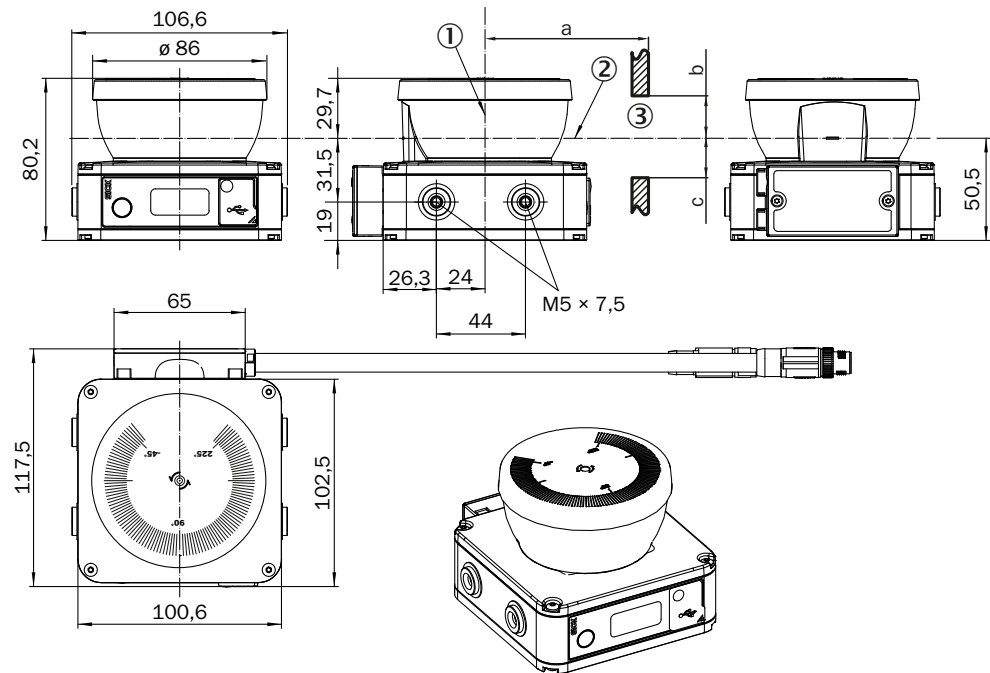

Figure 59: Dimensional drawing

All dimensions in mm.

- ① Mirror rotational axis
- ② Scan plane
- ③ Required viewing slit
 - a: Length of the viewing slit
 - b: Minimum height above the scan plane
 - c: Minimum height below the scan plane

Required viewing slit

If the device is installed in paneling, for example, you must ensure that the laser beam can exit unhindered. The reflected laser beam must also reach the device unhindered. That means the viewing slit must be large enough.

The required minimum height and width of the viewing slit depends on the following parameters, among others:

- Deviation from the ideal flatness of the scan field at the end of the viewing slit
- Light spot size at the end of the viewing slit
- Vibrations that affect the flatness of the scan field or the geometry of the viewing slit

For a viewing slit with length $a \leq 200$ mm, the viewing slit must be at least 28 mm high ($b, c \geq 14$ mm). The viewing slit must be wide enough to leave at least 16 mm of space free next to each field.

If the viewing slit is longer ($a > 200$ mm), a case-by-case consideration is required.

- Contact the responsible SICK subsidiary.

14 Ordering information

14.1 Scope of delivery

- Safety laser scanner without system plug
- Safety note
- Mounting instructions
- Operating instructions for download: www.sick.com

14.2 Ordering information

Table 40: Ordering information

| Designation | Type code | Part number |
|--------------------|-----------------|-------------|
| nanoScan3 Core I/O | NANS3-AAAZ30AN1 | 1100333 |
| nanoScan3 Pro I/O | NANS3-CAAZ30AN1 | 1100334 |

A system plug is required to operate the safety laser scanner, see "System plug", [page 134](#).

15 Spare parts

15.1 Additional spare parts

Table 41: Additional spare parts

| Part | Part number |
|-------------------------------------|-------------|
| Optics cover (with seal and screws) | 2111696 |

16 Accessories

16.1 System plug

Table 42: System plug

| Accessories for | | Connection type | Type code | Part number |
|--------------------|-------------|---|--------------------|-------------|
| Device | Part number | | | |
| nanoScan3 Core I/O | 1100333 | <ul style="list-style-type: none"> Cable with plug connector for voltage supply and inputs and outputs, length: 300 mm ¹⁾ | NANSX-AAABZZZZ1 | 2105106 |
| | 1100333 | <ul style="list-style-type: none"> Cable with plug connector for voltage supply and inputs and outputs, length: 300 mm ¹⁾ Cable with plug connector for network connection, length: 250 mm ²⁾ | NANSX-AAABAEZZ1 | 2104949 |
| nanoScan3 Pro I/O | 1100334 | <ul style="list-style-type: none"> Cable with plug connector for voltage supply and inputs and outputs, length: 300 mm ³⁾ | NANSX-AAACZZZZ1 | 2105107 |
| | 1100334 | <ul style="list-style-type: none"> Cable with plug connector for voltage supply and inputs and outputs, length: 300 mm ³⁾ Cable with plug connector for network connection, length: 250 mm ²⁾ | NANSX-AAACAEZZ1 | 2104860 |
| | 1100334 | <ul style="list-style-type: none"> Cable with flying leads for voltage supply and inputs and outputs, length: 880 mm ³⁾ | NANSX-AACCZZZZ1S01 | 2128781 |
| | 1100334 | <ul style="list-style-type: none"> Cable with flying leads for voltage supply and inputs and outputs, length: 2 m ³⁾ | NANSX-AACCZZZZ1 | 2105109 |
| | 1100334 | <ul style="list-style-type: none"> Cable with flying leads for voltage supply and inputs and outputs, length: 880 mm ³⁾ Cable with plug connector for network connection, length: 250 mm ²⁾ | NANSX-AACCAEZZ1S01 | 2128780 |
| | 1100334 | <ul style="list-style-type: none"> Cable with flying leads for voltage supply and inputs and outputs, length: 2 m ³⁾ Cable with plug connector for network connection, length: 250 mm ²⁾ | NANSX-AACCAEZZ1 | 2105108 |

1) Bend radius (with fixed installation) ≥ 30 mm , bend radius (with flexible installation) ≥ 56 mm

2) Bend radius (with fixed installation) ≥ 26 mm , bend radius (with flexible installation) ≥ 51 mm

3) Bend radius (with fixed installation) ≥ 46 mm , bend radius (with flexible installation) ≥ 92 mm

16.2 Additional accessories

Suitable accessories are available at www.sick.com. Enter the product part number in the search field (part number: see the type label entry in the “Ident. no.” field or in the “P/N” field). All suitable accessories are listed on the Accessories tab of the product page.

17 Glossary

| | |
|--|--|
| CoLa 2 | CoLa 2 (Command Language 2) is a protocol from SICK, with which a client (control, computer, etc.) can access suitable SICK sensors via a network (TCP/IP) or USB. |
| Contour detection field | The contour detection field monitors a contour of the environment. The electro-sensitive protective device switches the associated safety outputs to the OFF state if a contour does not correspond to the set specifications, e.g. because a door or flap is open. |
| Control input | <p>A control input receives signals, e.g. from the machine or from the control. Use of control inputs is how the protective device receives information about the conditions at the machine, e.g., if there is a change of operating mode. If the protective device is configured appropriately, it will activate a different monitoring case after receiving a new control input.</p> <p>The control input information must be transmitted reliably. Generally, at least 2 separate channels are used to do this.</p> <p>Depending on the device, a control input can be realized as a static control input or a dynamic control input.</p> |
| Dangerous state | <p>A dangerous state is a status of the machine or facility, where people may be injured. Protective devices prevent this risk if the machine is operated within its intended use.</p> <p>The figures in this document always show the dangerous state of the machine as movement of a machine part. In practice, there are different dangerous states, such as:</p> <ul style="list-style-type: none"> • Machine movements • Electrical parts • Visible and invisible beam • A combination of multiple hazards |
| Dynamic control input | A dynamic control input is a single-channel control input that evaluates a number of pulses per time. An incremental encoder can be connected to a dynamic control input. The incremental encoder reports, for example, the speed of an AGV. In conjunction with a second control input, a dynamic control input is used to switch between different monitoring cases depending on the speed. |
| EDM | External device monitoring |
| Electro-sensitive protective device | <p>An electro-sensitive protective device is a device or system of devices for safety-related detection of people or parts of the body.</p> <p>It is used to protect people from machines and facilities that pose a risk of injury. It triggers the machine or facility to adopt a safe state before a person is exposed to a hazardous situation.</p> <p>Examples: Safety light curtain, safety laser scanner.</p> |
| ESD | Electrostatic discharge |
| ESPE | Electro-sensitive protective device |
| External device monitoring | <p>The external device monitoring (EDM) monitors the status of downstream contactors.</p> <p>In order to use external device monitoring, positively guided contactors must be used to switch off the machine. If the auxiliary contacts of the positively guided contactors are connected to the external device monitoring, the external device monitoring checks whether the contactors switch correctly when the OSSDs are switched off.</p> |

| | |
|--------------------------------|--|
| Field set | <p>A field set consists of one or more fields. The fields in a field set are monitored simultaneously.</p> <p>A field set can contain different field types, e.g., a protective field and a warning field.</p> |
| Hazardous area | <p>Hazardous area is any space within and/or around machinery in which a person can be exposed to a hazard. (ISO 12100)</p> |
| Incremental encoder | <p>An incremental encoder generates electrical pulses proportional to a movement. Various physical quantities can be derived from these pulses, e.g. speed and distance covered.</p> |
| Monitoring case | <p>A monitoring case indicates the machine status to the sensor. Generally, one field set is assigned to each monitoring case.</p> <p>The sensor receives a defined signal for the current machine status. When a signal change occurs, the sensor activates the monitoring case and thereby the field set that is associated with the new machine status.</p> |
| OFF state | <p>The OFF state is the status of the outputs of the protective device, where the controlled machine is triggered to quit its dangerous state and the start-up of the machine is prevented (e.g., the voltage at the OSSDs is LOW, so that the machine is switched off and remains still).</p> |
| ON state | <p>The ON state is the status of the outputs of the ESPE, where the controlled machine is permitted to operate (e.g., the voltage at the OSSDs is HIGH so that the machine can run).</p> |
| OSSD | <p>Output signal switching device: signal output for the protective device, which is used for stopping the dangerous movement.</p> <p>An OSSD is a safety switching output. The functionality of each OSSD is tested periodically. OSSDs are always connected in pairs and must undergo dual-channel analysis for safety reasons. An OSSD pair is formed from 2 OSSDs that are connected and analyzed together.</p> |
| PFH_D | <p>Probability of dangerous failure per hour</p> |
| PL | <p>Performance level (ISO 13849)</p> |
| Protective field | <p>The protective field is the area in which the test object specified by the manufacturer is detected by the electro-sensitive protective equipment (ESPE). As soon as the electro-sensitive protective device detects an object in the protective field, it switches the associated safety outputs to the OFF state. This signal can be passed to controllers resulting in the dangerous state coming to an end, e.g. to stop the machine or the vehicle.</p> |
| Reference contour field | <p>The contour as reference field monitors a contour of the environment. The safety laser scanner switches all safety outputs to the OFF state if a contour does not match the set parameters, because, for example, the mounting of the safety laser scanner has been changed.</p> <p>National and international standards require or recommend that a reference contour is monitored, if the safety laser scanner is used in vertical operation for hazardous point protection or for access protection.</p> |

| | |
|--------------------------|---|
| Reset | <p>When a protective device has sent a stop command, the stopped state must be maintained until a reset device is activated and the machine can be restarted in a second step.</p> <p>The reset brings the protective device back to the monitoring state after it has sent a stop command. The reset also quits the start-up or restart interlock of a protective device, so that the machine can be restarted in a second step.</p> <p>The reset must only be possible, when all safety functions and protective devices are functional.</p> <p>The reset of the protective device must not introduce any movement or dangerous situations itself. The machine is only permitted to start after the reset once a separate start command has been sent.</p> <ul style="list-style-type: none"> • Manual resets are performed using a separate, manually operated device, such as a reset pushbutton. • Automatic resets by the protective device are only permitted in special cases, if one of the following conditions is met: <ul style="list-style-type: none"> ◦ It must not be possible for people to be in the hazardous area without triggering the protective device. ◦ It must be ensured that no people are in the hazardous area during or after the reset. |
| Resolution | The resolution of an active opto-electronic protective device (also known as the sensor detection capability) is the minimum size of an object for it to be reliably detected. |
| Response time | The protective device's response time is the maximum time between the occurrence of the event leading to the sensor's response and supply of the switch-off signal to the protective device's interface (for example OFF state of the OSSD pair). |
| Restart interlock | <p>The restart interlock prevents the machine from automatically starting up, for example after a protective device has responded while the machine is operating or after changing the machine's operating mode.</p> <p>The restart interlock can be implemented in the protective device or in the safety controller.</p> <p>A command to reset the protective device must be given, for example using a reset pushbutton, before the machine can be restarted.</p> |
| Retroreflector | A retroreflector reflects light back toward the light source largely independently of the alignment of the retroreflector. |
| RSSI | Received Signal Strength Indicator (RSSI): Indicator of the strength of the received signal. A higher value corresponds to a better reception. There is no universal relationship between a physical quantity and a specified RSSI. |
| Safety function | Function of a machine whose failure can result in an immediate increase of the risk(s). (ISO 12100) |
| Safety output | <p>A safety output provides safety-related information.</p> <p>Safety outputs are OSSDs, for example, or safety-related information on a safety-related network.</p> |
| Scan cycle time | <p>The scan cycle time is the time the sensor needs for a complete scan of its detection area.</p> <p>Example: Time required by the mirror of a safety laser scanner for one rotation.</p> |
| SIL | Safety integrity level |
| SILCL | SILCL: SIL claim limit. Designation in older versions of IEC 62061. Replaced by SIL in versions from 2021. |

| | |
|-----------------------------|---|
| Static control input | A static control input is a dual-channel control input, which evaluates the status of every channel as the value 0 or 1. The signal states of one or more static control inputs give a unique signal pattern. This signal pattern activates a monitoring case. |
| Universal I/O | Universal I/O can be configured as universal input or as universal output. |
| Universal input | Depending on the device, a universal input can be used for resetting, external device monitoring (EDM), sleep mode, or restarting the protective device, for example. If sleep mode is activated by a universal input, the sleep mode must not be used for safety applications. Certain universal inputs can also be used in pairs as a static control input. |
| Universal output | The function of a universal output is configurable. Which functions are available depends on the device. Possible signals are, for example: reset required, contamination warning. |
| Warning field | <p>The warning field monitors larger areas than the protective field. Simple switching functions can be triggered with the warning field, e.g. a warning light or an acoustic signal can be triggered if a person approaches, even before the person enters the protective field.</p> <p>The warning field must not be used for safety applications.</p> |

18 Annex

18.1 Conformities and certificates

You can obtain declarations of conformity, certificates, and the current operating instructions for the product at www.sick.com. To do so, enter the product part number in the search field (part number: see the entry in the “P/N” or “Ident. no.” field on the type label).

18.1.1 EU declaration of conformity

Excerpt

The undersigned, representing the manufacturer, herewith declares that the product is in conformity with the provisions of the following EU directive(s) (including all applicable amendments), and that the standards and/or technical specifications stated in the EU declaration of conformity have been used as a basis for this.

- ROHS DIRECTIVE 2011/65/EU
- EMC DIRECTIVE 2014/30/EU
- MACHINERY DIRECTIVE 2006/42/EC

18.1.2 UK declaration of conformity

Excerpt

The undersigned, representing the following manufacturer herewith declares that this declaration of conformity is issued under the sole responsibility of the manufacturer. The product of this declaration is in conformity with the provisions of the following relevant UK Statutory Instruments (including all applicable amendments), and the respective standards and/or technical specifications have been used as a basis.

- Restriction of the Use of Certain Hazardous Substances in Electrical and Electronic Equipment Regulations 2012
- Electromagnetic Compatibility Regulations 2016
- Supply of Machinery (Safety) Regulations 2008

18.2 Note on standards

Standards are specified in the information provided by SICK. The table shows regional standards with similar or identical contents. Not every standard applies to all products.

Table 43: Note on standards

| Standard | Standard (regional) |
|----------------|---------------------|
| | China |
| IEC 60068-2-6 | GB/T 2423.10 |
| IEC 60068-2-27 | GB/T 2423.5 |
| IEC 60204-1 | GB/T 5226.1 |
| IEC 60529 | GB/T 4208 |
| IEC 60825-1 | GB 7247.1 |
| IEC 61131-2 | GB/T 15969.2 |
| IEC 61140 | GB/T 17045 |
| IEC 61496-1 | GB/T 19436.1 |
| IEC 61496-2 | GB/T 19436.2 |
| IEC 61496-3 | GB 19436.3 |
| IEC 61508 | GB/T 20438 |

| Standard | Standard (regional) |
|-------------|---------------------|
| | China |
| IEC 62061 | GB 28526 |
| ISO 13849-1 | GB/T 16855.1 |
| ISO 13855 | GB/T 19876 |

18.3 Licenses

SICK uses open source software which is published by the rights holders under a free license. Among others, the following license types are used: GNU General Public License (GPL version 2, GPL version 3), GNU Lesser General Public License (LGPL), MIT license, zlib license and licenses derived from the BSD license.

This program is provided for general use without warranty of any kind. This warranty disclaimer also extends to the implicit assurance of marketability or suitability of the program for a particular purpose.

See the GNU General Public License for more information. For complete license texts, see www.sick.com/licensetexts. Printed copies of the license texts are also available on request.

18.4 Checklist for initial commissioning and commissioning

Checklist for manufacturers or installers for installing electro-sensitive protective device (ESPE)

The details relating to the items listed below must be available no later than when the system is commissioned for the first time. However, these depend on the specific application (the requirements of which must be reviewed by the manufacturer or installer).

This checklist should be retained and kept with the machine documentation to serve as reference during recurring tests.

This checklist does not replace the initial commissioning, nor the regular inspection by qualified safety personnel.

| | |
|---|--|
| Have the safety rules and regulations been observed in compliance with the directives and standards applicable to the machine? | Yes <input type="checkbox"/> No <input type="checkbox"/> |
| Are the applied directives and standards listed in the declaration of conformity? | Yes <input type="checkbox"/> No <input type="checkbox"/> |
| Does the protective device correspond to the required PL/SIL and PFHd in accordance with ISO 13849-1 / IEC 62061 and the required type in accordance with IEC 61496-1? | Yes <input type="checkbox"/> No <input type="checkbox"/> |
| Is access to the hazardous area or hazardous point only possible through the protective field of the ESPE? | Yes <input type="checkbox"/> No <input type="checkbox"/> |
| Have appropriate measures been taken to protect (mechanical protection) or monitor (protective devices) any persons or objects in the hazardous area when protecting a hazardous area or hazardous point, and have these devices been secured or locked to prevent their removal? | Yes <input type="checkbox"/> No <input type="checkbox"/> |
| Are additional mechanical protective measures fitted and secured against manipulation which prevent reaching below, above or around the ESPE? | Yes <input type="checkbox"/> No <input type="checkbox"/> |
| Has the maximum shutdown and/or stopping time of the machine been measured, specified and documented (at the machine and/or in the machine documentation)? | Yes <input type="checkbox"/> No <input type="checkbox"/> |
| Has the ESPE been mounted such that the required minimum distance from the nearest hazardous point has been achieved? | Yes <input type="checkbox"/> No <input type="checkbox"/> |
| Are the ESPE devices properly mounted and secured against manipulation after alignment? | Yes <input type="checkbox"/> No <input type="checkbox"/> |
| Are the required protective measures against electric shock in effect (protection class)? | Yes <input type="checkbox"/> No <input type="checkbox"/> |
| Is the control switch for resetting the protective devices (ESPE) or restarting the machine present and correctly installed? | Yes <input type="checkbox"/> No <input type="checkbox"/> |
| Are the outputs of the ESPE (OSSDs or safety outputs via the network) integrated according to the required PL/SIL in accordance with ISO 13849-1 / IEC 62061 and does the integration correspond to the circuit diagrams? | Yes <input type="checkbox"/> No <input type="checkbox"/> |
| Has the protective function been checked in compliance with the test notes of this documentation? | Yes <input type="checkbox"/> No <input type="checkbox"/> |
| Are the specified protective functions effective at every operating mode that can be set? | Yes <input type="checkbox"/> No <input type="checkbox"/> |
| Are the switching elements activated by the ESPE, e.g. contactors, valves, monitored? | Yes <input type="checkbox"/> No <input type="checkbox"/> |
| Is the ESPE effective over the entire period of the dangerous state? | Yes <input type="checkbox"/> No <input type="checkbox"/> |
| Once initiated, will a dangerous state be stopped when switching the ESPE on or off and when changing the operating mode, or when switching to another protective device? | Yes <input type="checkbox"/> No <input type="checkbox"/> |

19 List of figures

| | | |
|-----|--|----|
| 1. | Laser class 1..... | 10 |
| 2. | SICK product ID..... | 13 |
| 3. | Device overview..... | 13 |
| 4. | Principle of time-of-flight measurement..... | 14 |
| 5. | Light pulses scan an area..... | 15 |
| 6. | Hazardous area protection: detection of the presence of a person in the hazardous area..... | 17 |
| 7. | Hazardous point protection: Hand detection..... | 18 |
| 8. | Access protection: detection of a person when accessing a hazardous area..... | 18 |
| 9. | Mobile hazardous area protection: detection of a person when a vehicle approaches..... | 19 |
| 10. | Prevent crawling beneath..... | 21 |
| 11. | Prevent stepping over..... | 21 |
| 12. | Unsecured areas..... | 22 |
| 13. | Overrun of the protective field in front of an opening..... | 24 |
| 14. | Tolerance band of the contour as reference field (protective field within the protected opening, edge of the protected opening = reference contour)..... | 25 |
| 15. | Stationary application with horizontal scan plane for hazardous area protection..... | 27 |
| 16. | Protection against reaching over with low scan plane (dimensions in mm)..... | 28 |
| 17. | Protection against reaching over with high scan plane (dimensions in mm)..... | 29 |
| 18. | Scan plane at calf height..... | 30 |
| 19. | Distance of the protective field from the wall..... | 31 |
| 20. | Stationary application in vertical operation for hazardous point protection..... | 32 |
| 21. | Stationary application in vertical operation for access protection..... | 34 |
| 22. | Mobile application in horizontal operation for hazardous area protection..... | 35 |
| 23. | Flat-rate supplement for lack of ground clearance..... | 36 |
| 24. | Minimum supplement for lack of ground clearance..... | 37 |
| 25. | Stopping distance as a function of the vehicle's speed..... | 37 |
| 26. | Recommended fitting height..... | 39 |
| 27. | Recommended fitting height for inverted mounting..... | 39 |
| 28. | Dual-channel and isolated connection of an OSSD pair..... | 42 |
| 29. | No potential difference between load and protective device..... | 42 |
| 30. | How the restart interlock works (1): no one in protective field, machine operates..... | 46 |
| 31. | How the restart interlock works (2): person detected in protective field, safety output in OFF state..... | 46 |
| 32. | How the restart interlock works (3): person in hazardous area, no detection in protective field, safety output still in OFF state..... | 47 |
| 33. | How the restart interlock works (4): the reset pushbutton must be pressed before restarting the machine..... | 47 |
| 34. | Mounting safety laser scanner..... | 54 |
| 35. | Connecting cable (male connector, M12, 8-pin, A-coded)..... | 55 |
| 36. | Connecting cable (male connector, M12, 17-pin, A-coded)..... | 56 |
| 37. | Network pin assignment (M12 female connector, 4-pin, D-coding)..... | 59 |
| 38. | Software controls..... | 62 |
| 39. | Configuration..... | 64 |
| 40. | Overview..... | 66 |
| 41. | Contour as Reference field..... | 72 |
| 42. | Field editor..... | 74 |
| 43. | Editing fields using coordinates..... | 79 |
| 44. | Area that cannot be monitored..... | 80 |
| 45. | Inputs and outputs, local..... | 82 |
| 46. | Monitoring cases..... | 86 |
| 47. | Simulation..... | 90 |

| | |
|--|-----|
| 48. Data output..... | 91 |
| 49. Report..... | 94 |
| 50. Fixing screws for the optics cover..... | 108 |
| 51. Error indication..... | 113 |
| 52. Data recorder..... | 116 |
| 53. Event history..... | 117 |
| 54. Message history..... | 119 |
| 55. Switch-off tests..... | 128 |
| 56. Duration and time offset for the switch-off tests in an OSSD pair..... | 128 |
| 57. Range and object size for measured data output..... | 129 |
| 58. Range and required remission for measured data output..... | 130 |
| 59. Dimensional drawing..... | 131 |

20 List of tables

| | | |
|-----|---|-----|
| 1. | Target groups and selected sections of these operating instructions..... | 8 |
| 2. | Field types and their function..... | 16 |
| 3. | Status of the channels of the control inputs with complementary evaluation..... | 43 |
| 4. | True vales with 1-off-n-evaluation with 2 input pairs (example)..... | 43 |
| 5. | Network services and ports..... | 48 |
| 6. | Pin assignment of the connecting cable with 8-pin M12 plug connector..... | 56 |
| 7. | Pin assignment of the connecting cable with 17-pin M12 plug connector..... | 56 |
| 8. | Pin assignment of the connecting cable with flying leads, 17-wire..... | 58 |
| 9. | Network pin assignment..... | 59 |
| 10. | User groups..... | 63 |
| 11. | Type code in Safety Designer..... | 65 |
| 12. | Recommended multiple sampling..... | 71 |
| 13. | Buttons on the toolbar..... | 75 |
| 14. | Colors of the field types..... | 75 |
| 15. | Buttons for field sets..... | 76 |
| 16. | Manage field set templates..... | 76 |
| 17. | Background image..... | 77 |
| 18. | Settings for the field editor..... | 78 |
| 19. | Mask areas..... | 80 |
| 20. | Defining global field geometry..... | 81 |
| 21. | Propose field..... | 81 |
| 22. | Empirical values for the required input delay..... | 87 |
| 23. | Show/hide preset for specified cutoff behavior..... | 90 |
| 24. | Buttons..... | 98 |
| 25. | Status LEDs..... | 101 |
| 26. | Overview of status information..... | 102 |
| 27. | Error types (selection)..... | 113 |
| 28. | Data recorder..... | 116 |
| 29. | Print or export message history..... | 119 |
| 30. | Functional scope..... | 121 |
| 31. | Revision..... | 121 |
| 32. | Features..... | 122 |
| 33. | Safety-related parameters..... | 122 |
| 34. | Interfaces..... | 123 |
| 35. | Electrical data..... | 123 |
| 36. | Mechanical data..... | 125 |
| 37. | Ambient data..... | 125 |
| 38. | Miscellaneous data..... | 126 |
| 39. | Protective field range..... | 128 |
| 40. | Ordering information..... | 132 |
| 41. | Additional spare parts..... | 133 |
| 42. | System plug..... | 134 |
| 43. | Note on standards..... | 140 |

Australia

Phone +61 (3) 9457 0600
1800 33 48 02 – tollfree
E-Mail sales@sick.com.au

Austria

Phone +43 (0) 2236 62288-0
E-Mail office@sick.at

Belgium/Luxembourg

Phone +32 (0) 2 466 55 66
E-Mail info@sick.be

Brazil

Phone +55 11 3215-4900
E-Mail comercial@sick.com.br

Canada

Phone +1 905.771.1444
E-Mail cs.canada@sick.com

Czech Republic

Phone +420 234 719 500
E-Mail sick@sick.cz

Chile

Phone +56 (2) 2274 7430
E-Mail chile@sick.com

China

Phone +86 20 2882 3600
E-Mail info.china@sick.net.cn

Denmark

Phone +45 45 82 64 00
E-Mail sick@sick.dk

Finland

Phone +358-9-25 15 800
E-Mail sick@sick.fi

France

Phone +33 1 64 62 35 00
E-Mail info@sick.fr

Germany

Phone +49 (0) 2 11 53 010
E-Mail info@sick.de

Greece

Phone +30 210 6825100
E-Mail office@sick.com.gr

Hong Kong

Phone +852 2153 6300
E-Mail ghk@sick.com.hk

Hungary

Phone +36 1 371 2680
E-Mail ertekeletes@sick.hu

India

Phone +91-22-6119 8900
E-Mail info@sick-india.com

Israel

Phone +972 97110 11
E-Mail info@sick-sensors.com

Italy

Phone +39 02 27 43 41
E-Mail info@sick.it

Japan

Phone +81 3 5309 2112
E-Mail support@sick.jp

Malaysia

Phone +603-8080 7425
E-Mail enquiry.my@sick.com

Mexico

Phone +52 (472) 748 9451
E-Mail mexico@sick.com

Netherlands

Phone +31 (0) 30 204 40 00
E-Mail info@sick.nl

New Zealand

Phone +64 9 415 0459
0800 222 278 – tollfree
E-Mail sales@sick.co.nz

Norway

Phone +47 67 81 50 00
E-Mail sick@sick.no

Poland

Phone +48 22 539 41 00
E-Mail info@sick.pl

Romania

Phone +40 356-17 11 20
E-Mail office@sick.ro

Singapore

Phone +65 6744 3732
E-Mail sales.gsg@sick.com

Slovakia

Phone +421 482 901 201
E-Mail mail@sick-sk.sk

Slovenia

Phone +386 591 78849
E-Mail office@sick.si

South Africa

Phone +27 10 060 0550
E-Mail info@sickautomation.co.za

South Korea

Phone +82 2 786 6321/4
E-Mail infokorea@sick.com

Spain

Phone +34 93 480 31 00
E-Mail info@sick.es

Sweden

Phone +46 10 110 10 00
E-Mail info@sick.se

Switzerland

Phone +41 41 619 29 39
E-Mail contact@sick.ch

Taiwan

Phone +886-2-2375-6288
E-Mail sales@sick.com.tw

Thailand

Phone +66 2 645 0009
E-Mail marcom.th@sick.com

Turkey

Phone +90 (216) 528 50 00
E-Mail info@sick.com.tr

United Arab Emirates

Phone +971 (0) 4 88 65 878
E-Mail contact@sick.ae

United Kingdom

Phone +44 (0)17278 31121
E-Mail info@sick.co.uk

USA

Phone +1 800.325.7425
E-Mail info@sick.com

Vietnam

Phone +65 6744 3732
E-Mail sales.gsg@sick.com

Detailed addresses and further locations at www.sick.com

