

MPS-C

Magnetic position sensor

SICK
Sensor Intelligence.



Described product

MPS-C sensor for C-slot cylinders

Manufacturer

SICK AG
Erwin-Sick-Str. 1
79183 Waldkirch
Germany

Legal information

This work is protected by copyright. Any rights derived from the copyright shall be reserved for SICK AG. Reproduction of this document or parts of this document is only permissible within the limits of the legal determination of Copyright Law. Any modification, abridgment or translation of this document is prohibited without the express written permission of SICK AG.

The trademarks stated in this document are the property of their respective owner.

© SICK AG. All rights reserved.

Original document

This document is an original document of SICK AG.

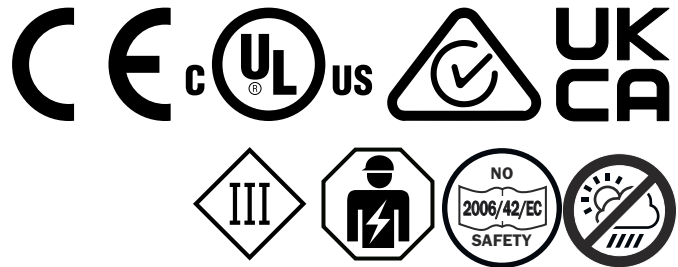

Contents

1	About this document.....	5
1.1	Further information.....	5
1.2	Symbols and document conventions.....	5
2	Safety information.....	6
2.1	Intended use.....	6
2.2	Improper use.....	6
2.3	Limitation of liability.....	6
2.4	Requirements for skilled persons and operating personnel.....	7
2.5	Hazard warnings and operational safety.....	7
2.6	Repairs.....	7
3	Product description.....	8
3.1	Product ID.....	8
3.2	Product characteristics.....	8
4	Transport and storage.....	10
4.1	Transport.....	10
4.2	Transport inspection.....	10
4.3	Storage.....	10
5	Mounting.....	11
5.1	Preparation for mounting.....	11
5.2	Mounting the sensor.....	11
6	Electrical installation.....	13
6.1	Safety.....	13
6.2	Pin allocation of the connections.....	15
6.3	Connecting the supply voltage.....	15
6.4	Wiring the digital switching output.....	16
7	Commissioning.....	17
7.1	Overview of commissioning steps.....	17
7.2	Commissioning the sensor for the first time.....	17
8	Operation.....	18
8.1	IO-Link.....	18
8.2	Operating and status indicators.....	18
8.3	General notes on operation.....	19
8.4	Teach-in mode.....	22
9	Maintenance.....	33
9.1	Maintenance.....	33
9.2	Repairs.....	33

10	Decommissioning.....	34
11	Technical data.....	35
11.1	Performance.....	35
11.2	Interfaces.....	35
11.3	Mechanics/electronics.....	35
11.4	Ambient data.....	36
12	Annex.....	37
12.1	Conformities and certificates.....	37

1 About this document

1.1 Further information

You can find the product page with further information under the **SICK Product ID** at: pid.sick.com/{P/N}.

P/N corresponds to the part number of the product.

The following information is available depending on the product:

- Data sheets
- These publication in all available languages
- CAD files and dimensional drawings
- Certificates (e.g., declaration of conformity)
- Other publications
- Software
- Accessories

1.2 Symbols and document conventions

Warnings and other notes



DANGER

Indicates a situation presenting imminent danger, which will lead to death or serious injuries if not prevented.



WARNING

Indicates a situation presenting possible danger, which may lead to death or serious injuries if not prevented.



CAUTION

Indicates a situation presenting possible danger, which may lead to moderate or minor injuries if not prevented.



NOTICE

Indicates a situation presenting possible danger, which may lead to property damage if not prevented.



NOTE

Highlights useful tips and recommendations as well as information for efficient and trouble-free operation.

Instructions to action

- ▶ The arrow denotes instructions to action.
- 1. The sequence of instructions is numbered.
- 2. Follow the order in which the numbered instructions are given.
- ✓ The tick denotes the results of an action.

2 Safety information

2.1 Intended use

The sensor from the MPS-C product family is an intelligent, magnetic position sensor. It is used for non-contact detection of the piston stroke of pneumatic drives with axially magnetized permanent magnets.

SICK AG assumes no liability for losses or damage arising from the use of the product, either directly or indirectly. This applies in particular to use of the product that does not conform to its intended purpose and is not described in this documentation.



NOTICE

Radio interference may occur when the sensor is used in residential areas!

- ▶ Only use the device in industrial environments (EN 61000-6-4).
-

2.2 Improper use

- The sensor does not constitute a safety-relevant device according to the EC Machinery Directive (2006/42/EC).
- The sensor must not be used in explosion-hazardous areas.
- Any other use that is not described as intended use is prohibited.
- Any use of accessories not specifically approved by SICK AG is at your own risk.
- The sensor is not suitable for outdoor applications.



NOTICE

Danger due to improper use!

Any improper use can result in dangerous situations.

Therefore, take note of the following information:

- ▶ The sensor should be used only in line with intended use specifications.
 - ▶ All information in these operating instructions must be strictly complied with.
-

2.3 Limitation of liability

Applicable standards and regulations, the latest state of technological development, and our many years of knowledge and experience have all been taken into account when assembling the data and information contained in these operating instructions. The manufacturer accepts no liability for damage caused by:

- Failing to observe the operating instructions
- Improper use
- Use by untrained personnel
- Unauthorized conversions
- Technical modifications
- Use of unauthorized spare parts, consumables, and accessories

With special variants, where optional extras have been ordered, or owing to the latest technical changes, the actual scope of delivery may vary from the features and illustrations shown here.

2.4 Requirements for skilled persons and operating personnel



WARNING

Risk of injury due to insufficient training.

Improper handling of the sensor may result in considerable personal injury and material damage.

- All work must only ever be carried out by the stipulated persons.

The operating instructions state the following qualification requirements for the various areas of work:

- **Instructed personnel** have been briefed by the operating entity about the tasks assigned to them and about potential dangers arising from improper action.
- **Skilled personnel** have the specialist training, skills, and experience, as well as knowledge of the relevant regulations, to be able to perform tasks assigned to them and to detect and avoid any potential dangers independently.
- **Electricians** have the specialist training, skills, and experience, as well as knowledge of the relevant standards and provisions to be able to carry out work on electrical systems and to detect and avoid any potential dangers independently. In Germany, electricians must meet the specifications of the BGV A3 Work Safety Regulations (e.g., Master Electrician). Other relevant regulations applicable in other countries must be observed.

The following qualifications are required for various activities:

Activities	Qualification
Mounting, maintenance	<ul style="list-style-type: none"> ■ Basic practical technical training ■ Knowledge of the current safety regulations in the workplace
Electrical installation, device replacement	<ul style="list-style-type: none"> ■ Practical electrical training ■ Knowledge of current electrical safety regulations ■ Knowledge of the operation and control of the devices in their particular application
Commissioning, configuration	<ul style="list-style-type: none"> ■ Basic knowledge of the design and setup of the described connections and interfaces ■ Basic knowledge of data transmission ■ Knowledge of the operation and control of the devices in their particular application
Operation of the devices in their particular application	<ul style="list-style-type: none"> ■ Knowledge of the operation and control of the devices in their particular application ■ Knowledge of the software and hardware environment in the application

2.5 Hazard warnings and operational safety

Please observe the safety notes and the warnings listed here and in other chapters of these operating instructions to reduce the possibility of risks to health and avoid dangerous situations.

2.6 Repairs

Repair work on the sensor may only be performed by qualified and authorized personnel from SICK AG. Interruptions or modifications to the sensor on the part of the customer will invalidate any warranty claims against SICK AG.

3 Product description

3.1 Product ID

3.1.1 Type label

The type label gives information for identification of the sensor.

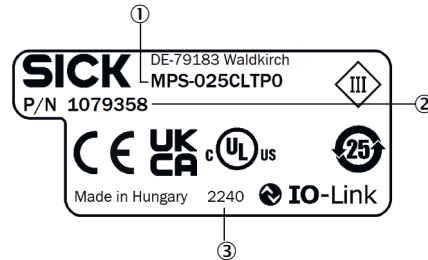

- ① Type code
- ② Article number (P/N)
- ③ Production date (yyww)

3.1.2 Device view



- ① Setscrew 2
- ② LED window 2
- ③ LED window 1
- ④ Keypad
- ⑤ Setscrew 1
- ⑥ Connection

3.2 Product characteristics

3.2.1 Product features

The MPS-C position sensor is used for non-contact linear position measurement mainly on pneumatic cylinders, grippers, and slides with C-slots.

3.2.2 Operating principle

Principle of operation

The MPS-C determines the position of an encoder magnet via a row of Hall sensors.

Resolution

The sensor resolution describes the minimum, specifiable magnet route change as output by the sensor.

Sampling rate

The sampling rate indicates the time interval in which the signal is updated at the outputs.

Speed

When specifying the speed, a distinction is made between “full stroke operation” and “partial stroke operation”.

In full stroke operation, the piston stroke is less than the measuring range and the magnet does not leave the measuring range.

In partial stroke operation, the piston stroke is greater than the measuring range and the magnet leaves the measuring range.

The piston speed is max. 3 m/s and max. 1.5 m/s for full stroke and partial stroke operation respectively.

Repeatability/Reproducibility

Repeatability/reproducibility is defined as any move to a preset position from the same direction in every case.

Blind zone

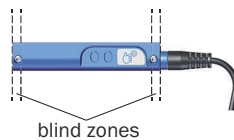

Figure 1: Sensor blind zones

The total length of the sensor is slightly longer than its measuring range. The difference is called the blind zone. The blind zone is 7.5 mm on each side.

Linearity error

The linearity error describes the maximum deviation of the output signal from an ideal straight line. It is measured in millimeters.

4 Transport and storage

4.1 Transport

For your own safety, please read and observe the following notes:



NOTE

Damage to the sensor due to improper transport.

- The device must be packaged for transport with protection against shock and damp.
- Recommendation: Use the original packaging as it provides the best protection.
- Transport should be performed by specialist staff only.
- The utmost care and attention is required at all times during unloading and transportation on company premises.
- Note the symbols on the packaging.
- Do not remove packaging until immediately before you start mounting.

4.2 Transport inspection

Immediately upon receipt at the receiving work station, check the delivery for completeness and for any damage that may have occurred in transit. In the case of transit damage that is visible externally, proceed as follows:

- Do not accept the delivery or only do so conditionally.
- Note the scope of damage on the transport documents or on the transport company's delivery note.
- File a complaint.



NOTE

Complaints regarding defects should be filed as soon as these are detected. Damage claims are only valid before the applicable complaint deadlines.

4.3 Storage

Store the device under the following conditions:

- Recommendation: Use the original packaging.
- Do not store outdoors.
- Store in a dry area that is protected from dust.
- So that any residual damp can evaporate, do not package in airtight containers.
- Do not expose to any aggressive substances.
- Protect from sunlight.
- Avoid mechanical shocks.
- Storage temperature: see "Technical data", page 35.
- Relative humidity: see "Technical data", page 35.
- For storage periods of longer than 3 months, check the general condition of all components and packaging on a regular basis.

5 Mounting

5.1 Preparation for mounting

5.1.1 Mounting requirements



NOTICE

Radio interference may occur when the sensor is used in residential areas!

Only use the device in industrial environments (EN 61000-6-4).

- Typical space requirements for sensor, see ["Mechanics/electronics", page 35](#).
- Comply with technical data, such as the permitted ambient conditions for operation of the sensor (e.g., temperature range, EM interference emissions), see ["Technical data", page 35](#).
- To prevent condensation, avoid exposing the sensor to rapid changes in temperature.
- Protect the sensor from direct sunlight.
- Only mount the sensor using the screw connections provided for this purpose.

Mounting location

When selecting the mounting location, the following factors must be considered:

- The mounting location must be as free from (electro)magnetic disturbance fields as possible.
- Mounting the sensor requires a C-slot that runs parallel to the magnet's axis of motion.
- The distance (length of cable) to the IO-Link master must not exceed 20 m.

Equipment required

- Tool and tape measure.

5.1.2 Scope of delivery

The sensor's scope of delivery includes:

- 1 MPS-C sensor in the version ordered
- 1 set of quick-start instructions
- 1 "IO-Link" leaflet
- 1 Allen wrench (size 1.5 mm)

Accessories:

Accessories (such as cables and fixing adapters) are only provided if they are ordered separately.

5.2 Mounting the sensor



NOTICE

Risk of damage to the sensor

If the setscrews on the sensor housing are tightened excessively, the sensor may be damaged.

- ▶ Observe the maximum tightening torque of 0.4 Nm.

Mounting the sensor

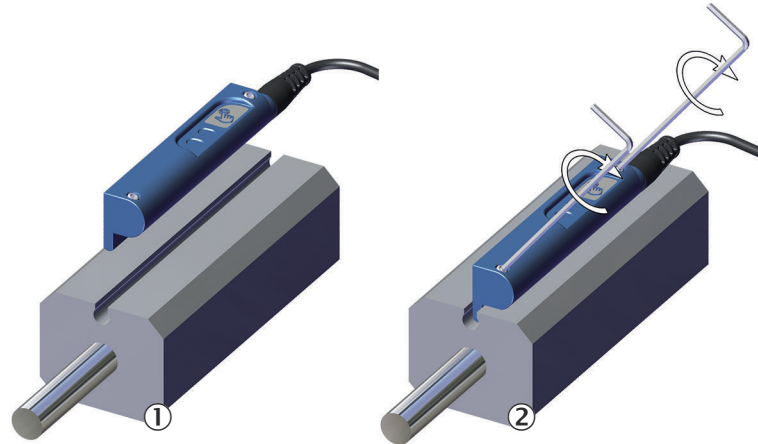

Figure 2: Mounting the sensor in the C-slot

1. Insert the sensor into the C-slot ①.
2. Push the sensor into the required position.
Take into account the measuring object length and the blind zones of the sensor.
3. Push the sensor into the C-slot and tighten the setscrews slightly.
4. Use the tape measure to check the position of the sensor and correct it if necessary.
5. Push the sensor into the C-slot and tighten both setscrews between 0.2 Nm and 0.4 Nm②.

6 Electrical installation

6.1 Safety

6.1.1 Notes on the electrical installation



CAUTION

Danger due to incorrect supply voltage!

An incorrect supply voltage may result in injuries from electric shocks and/or damage to the device.

- Only operate the sensor with safety extra-low voltage (SELV).



NOTICE

Sensor damage or unpredictable operation due to working with live parts.

Working with live parts may result in unpredictable operation.

- Only carry out wiring work when the power is off.
- Only connect and disconnect electrical connections when the power is off.

- **The electrical installation must only be performed by electrically qualified personnel.**
- **Standard safety requirements must be met when working in electrical systems.**
- Only switch on the supply voltage for the device when the connection tasks have been completed and the wiring has been thoroughly checked.
- When using extension cables with open ends, ensure that bare wire ends do not come into contact with each other (risk of short-circuit when supply voltage is switched on!). Wires must be appropriately insulated from each other.
- Wire cross-sections in the supply cable from the customer's power system must be designed in accordance with the applicable standards. When this is being done in Germany, observe the following standards: DIN VDE 0100 (Part 430) and DIN VDE 0298 (Part 4) and/or DIN VDE 0891 (Part 1).
- Circuits connected to the device must be designed as SELV circuits (SELV = Safety Extra Low Voltage).
- Protect the device with a separate fuse at the start of the supply circuit.

A shielded cable is not required in order to adhere to the electromagnetic compatibility guidelines specified by EN 61000-6-2/4. It is recommended, however, especially when working with longer connecting cables.

The IP enclosure rating for the sensor is only achieved if the connected cable is completely screwed in.

6.1.2 Wiring notes



NOTE

Preassembled cables can be found online at:

- ▶ www.sick.com/mps-c

Please observe the following wiring notes:

- During installation, pay attention to the different cable groups. The cables are grouped into the following four groups according to their sensitivity to interference or radiated emissions:

- Group 1: Cables very sensitive to interference, such as analog measuring cables
- Group 2: Cables sensitive to interference, such as sensor cables, communication signals, bus signals
- Group 3: Cables which are a source of interference, such as control cables for inductive loads, motor brakes
- Group 4: Cables which are powerful sources of interference, such as output cables from frequency inverters, welding system power supplies, power cables
- ▶ Cables in groups 1, 2 and 3, 4 must be crossed at right angles, [see figure 3](#).
- ▶ Cables in groups 1, 2 and 3, 4 must be routed in different cable channels or metallic separators must be used, [see figure 4](#) and [see figure 5](#). This applies particularly where cables of devices with a high level of radiated emission, such as frequency converters, are laid parallel to sensor cables.

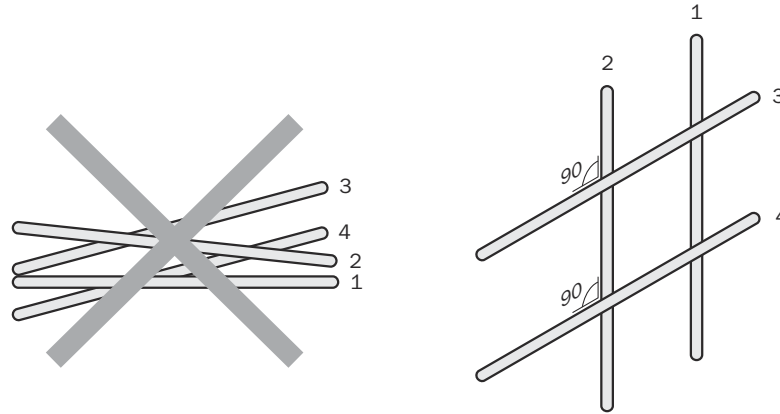

Figure 3: Cross cables at right angles

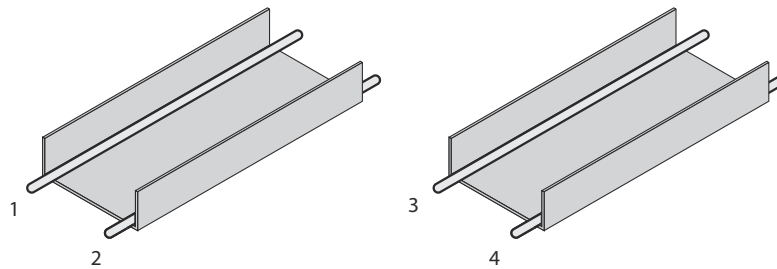

Figure 4: Ideal laying - Place cables in different cable channels

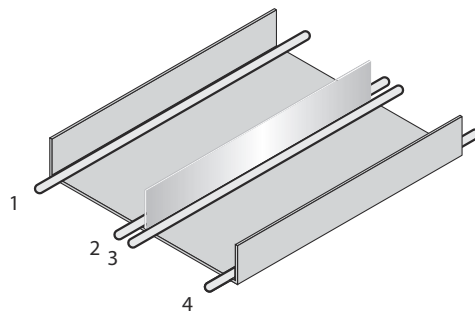

Figure 5: Alternative laying - Separate cables with metallic separators



NOTE

Prevent equipotential bonding currents via the cable shield with a suitable grounding method, [see "Safety", page 13](#).

6.2 Pin allocation of the connections

M8 connection

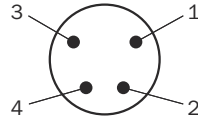

Figure 6: Pin assignment: M8-male, A-coded, 4-pin

Pin	Wire color	Pin assignment
1	Brown	L+
2	White	U_{out}/I_{out}
3	Blue	GND
4	Black	Q/IO-Link

M12 connection

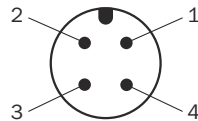

Figure 7: Pin assignment: M12-male, A-coded, 4-pin

Pin	Wire color	Pin assignment
1	Brown	L+
2	White	U_{out}/I_{out}
3	Blue	GND
4	Black	Q/IO-Link

Cable outlet

Wire color	Pin assignment
Brown	L+
White	U_{out}/I_{out}
Blue	GND
Black	Q/IO-Link

6.3 Connecting the supply voltage

The sensor must be connected to a voltage supply with the following properties:

- Supply voltage: DC 12 V ... 30 V (stabilized safety extra low voltage SELV as per currently valid standard EN 60950-1)
- Electricity source with at least 5 W power

Protecting the supply cables

To ensure protection against short-circuits/overload in the customer's supply cables, the conductor cross sections used must be appropriately selected and protected.

The following standards must be observed in Germany:

- DIN VDE 0100 (part 430)
- DIN VDE 0298 (part 4) and/or DIN VDE 0891 (part 1)

6.4 Wiring the digital switching output

The switching output is short-circuit protected, temperature-protected, and not electrically isolated from U_V .

Logic:

active HIGH switching (push) to supply voltage U_V .

active LOW switching (pull) to ground (GND).



NOTICE

NOTE! The active LOW state is not a NPN switching output according to EN60947-5-2!

Electrical values

$$0 \text{ V} \leq U_a \leq U_V$$

Push (HIGH): $(U_V - 2 \text{ V}) \leq U_a \leq U_V$ at $I_a \leq 100 \text{ mA}$

Pull (LOW): $0 \leq U_a \leq 2 \text{ V}$ at $I_a = 100 \text{ mA}$

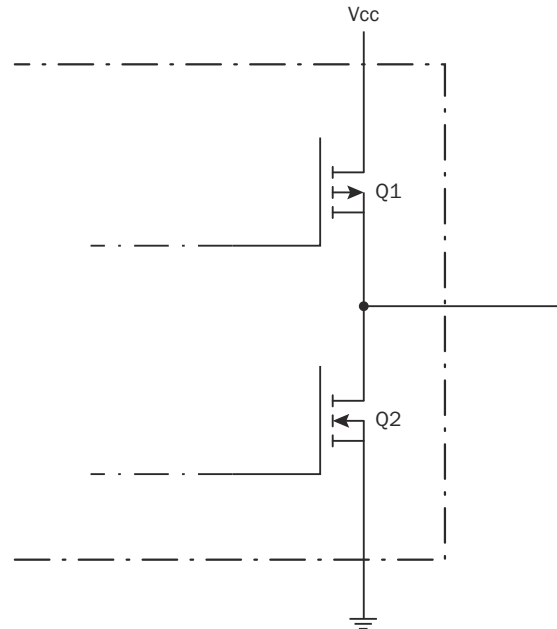

Figure 8: Wiring the switching output

7 Commissioning

7.1 Overview of commissioning steps

- Connect the voltage supply.
- Commission the sensor using the factory settings.
- Configure the sensor.

7.2 Commissioning the sensor for the first time

1. Connect the voltage supply.
2. Wait until the yellow LED stops flashing (sensor is ready for operation).
The magnet may need to be moved inside the measuring range in order to be taught into the sensor.



NOTE

When the sensor is ready for operation and a sufficiently strong magnet field is registered in the measuring range, the LED lights up permanently. The yellow LED goes out if no magnet is registered in the measuring range.

The yellow LED flashes at 4 Hz if an error is detected.

The sensor is supplied with the following settings, made at the factory:

- Current output active (analog), IO-Link operation possible
- Measuring range fully active

To configure the sensor, either the capacitive keypad (see "Operation", page 18) or IO-Link is used.

8 Operation

8.1 IO-Link

In addition to manual configuration, the sensor can also be configured using IO-Link.

A detailed list of IO-Link functions can be found on the leaflet supplied with the sensor or at www.sick.com.

You can find the IODD file at www.sick.com/mps-c.

8.2 Operating and status indicators

Operating indicator

The sensor has a capacitive keypad for performing configuration and setting parameters.

The MPS-C capacitive keypad features dynamic switching threshold adjustment. If environmental effects cause the switching threshold to move significantly, leading to a keypad malfunction, the sensor will detect the move after five seconds and the switching threshold will be recalibrated.

The keypad will then be ready to be pressed again. The user can also perform recalibration by pressing and holding the relevant key for more than five seconds.



NOTE

If the sensor detects an invalid unlocking attempt, the capacitive keypad will be locked for three seconds. After this, locking can be attempted again.

Operation is carried out by pressing a series of keys with various time windows:

Press: Touch the keypad from 0.1 to 0.5 s, then release (> 0.1 s).

Hold: Touch the keypad for several seconds without releasing.

Lift finger: The finger does not touch the keypad for several seconds.



NOTE

Operating the keypad requires a little practice because the response times are limited and the required settings are configured with time dependence.

Tip: Memorize the series for the required settings before you configure the sensor.

You will find a full description of the configuration options starting from [page 22](#).











Status indicators



The table below describes the individual function displays. The actual behavior of the LEDs during operation represents a combination of these function displays.



NOTE

The behavior of the LEDs in teach-in mode differs from the table below. See the information in the individual sections relating to the teach-in steps.

Category	Mode	LED1	LED2	Description
System status	Operation			Sensor ready for operation/current output selected
				Sensor ready for operation/voltage output selected
	IO-Link			IO-Link connection active
	Error			Sensor not ready for operation/LED flashing at 4 Hz
Analog output	Voltage output			Analog voltage output active
	Current output			Analog current output active
Digital switching output	HIGH			Switching output signal level /switching signal present
	Overload			Overload at digital switching output
Magnet field	In measuring range			Magnet field registered in measuring range
	Outside measuring range			

 = lights up,  = flashes,  = LED off

8.3 General notes on operation

8.3.1 Analog operation



NOTE

If the sensor is carrying out cyclic IO-Link communication, the analog output is deactivated.

If the sensor is being operated with an analog interface, the position values are output as analog values in the 0 ... 10 V or 4 ... 20 mA range.

This output can be inverted so that analog values of 10 ... 0 V and 20 ... 4 mA are output.



NOTE

Following initialization, the magnet is deemed to be outside the measuring range until the first valid measured value has been identified.

8.3.2 Digital operation



NOTE

In each switching mode, all the following conditions must be adhered to:

- SP1 + hysteresis < working range
- SP2 + hysteresis < working range
- SP1 - hysteresis > 0
- SP2 - hysteresis > 0

8.3.2.1 Hysteresis

A hysteresis is used for the switching points in “single point”, “cylinder switch”, and “window” modes.

When the factory settings apply, the hysteresis is set to a value of 0.5 mm; however, it can be defined as a value between 0.05 mm and 20 mm using IO-Link.

The graphics for the mode in question tell you how the hysteresis is used.

8.3.2.2 Single point mode

Single point mode defines a switching point (SP1); below this point, the switching output is switched to active. The hysteresis is in the lower range of the switching point.

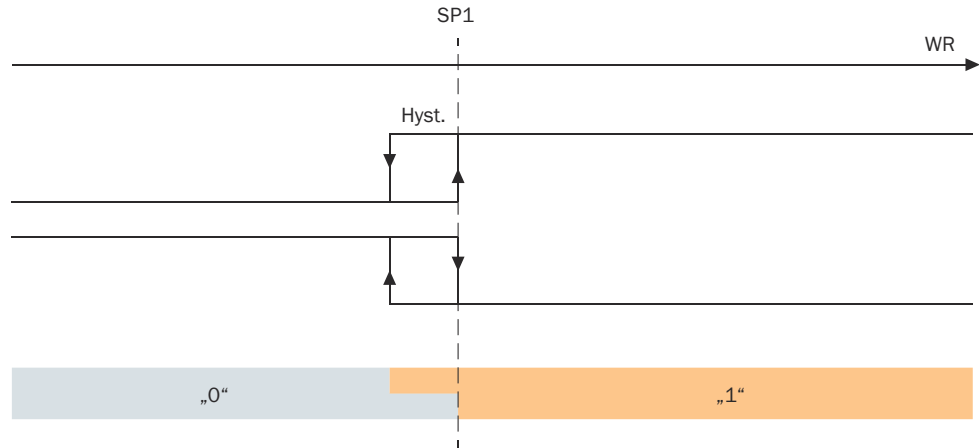

Figure 9: Switching behavior in single point mode (default: top; inverted: bottom)

- SP1** Switching point SP1
- WR** Working range
- Hyst.** Hysteresis

8.3.2.3 Cylinder switch mode

Cylinder switch mode defines a switching point (SP1) with a surrounding range within which the switching output is switched to active. This range is defined as 3 mm.

The hysteresis is above and below this range.



NOTE

Additional condition: $\text{hysteresis} < |\text{SP1} - \text{SP2}|$

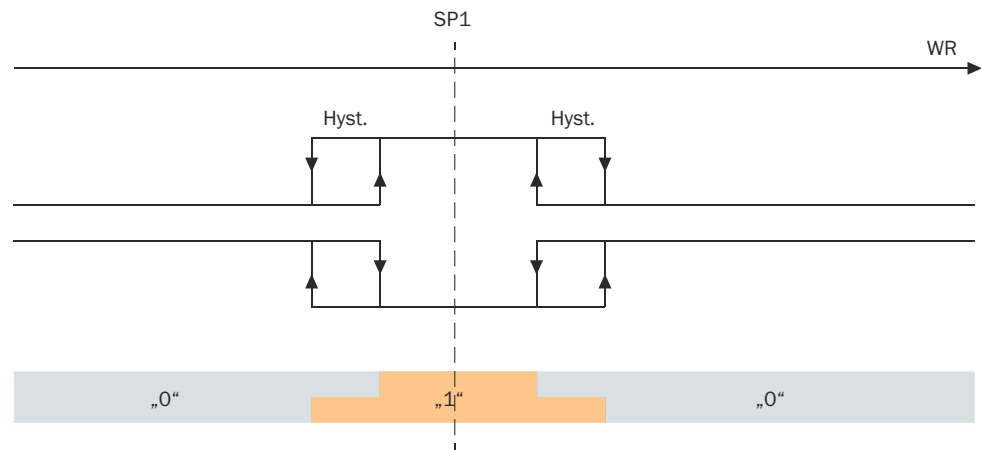

Figure 10: Switching behavior in cylinder switch mode (default: top; inverted: bottom)

SP1 Switching point SP1
WR Working range
Hyst. Hysteresis

8.3.2.4 Window mode

For each switching point (SP1 and SP2), window mode defines a range within which the switching output is switched to active.

The hysteresis is at the corresponding switching point in each case.



NOTE

Additional conditions:

- $SP1 + 1.5 \text{ mm} + 1 * \text{hysteresis} < \text{working range}$
- $SP1 - 1.5 \text{ mm} - 1 * \text{hysteresis} > 0$

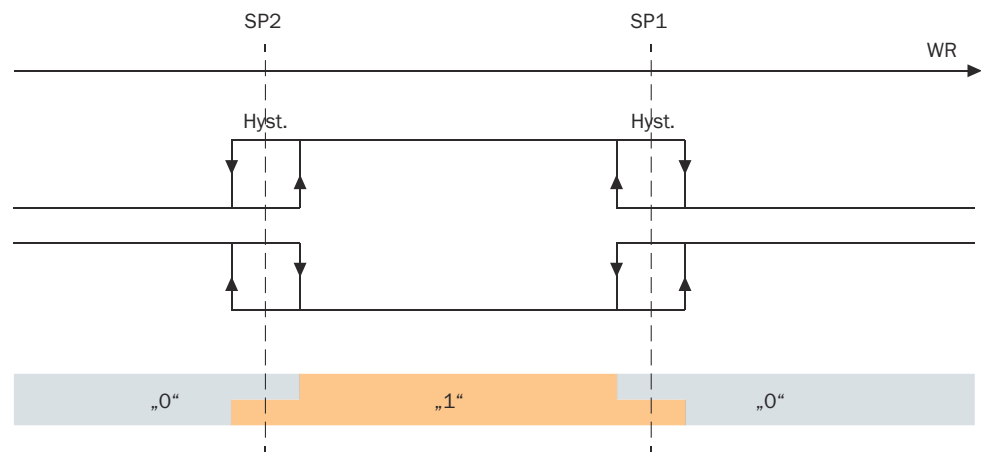

Figure 11: Switching behavior in window mode (default: top; inverted: bottom)

SP1 Switching point SP1
SP2 Switching point SP2
WR Working range
Hyst. Hysteresis

8.3.2.5 Two point mode

For each switching point (SP1 and SP2), two point mode defines an upper switching limit and a lower switching limit within which the switching output is switched to active or deactivated.

This mode does not use a hysteresis.



NOTE

Two point mode can only be set via IO-Link.

If this mode has been set, it can still be used even without an IO-Link connection.

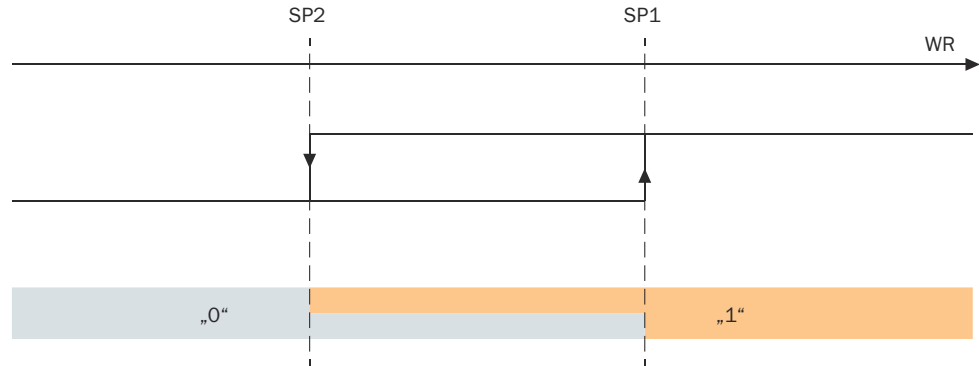

Figure 12: Switching behavior in two point mode (default: top; inverted: bottom)

- SP1 Switching point SP1
- SP2 Switching point SP2
- WR Working range

8.4 Teach-in mode

8.4.1 General information on teach-in mode

In teach-in mode, the current mode is displayed by the LEDs lighting up in a specific way.

8.4.1.1 Calling up teach-in mode

To activate teach-in mode, press and hold the keypad until the required teach-in mode is reached.

8.4.1.2 Timeouts

After 90 seconds of inactivity, the sensor automatically exits teach-in mode and reverts to normal operation.

If the keypad is pressed and held for more than 15 seconds in teach-in mode, this will also cause the sensor to exit teach-in mode.

A timeout is also triggered if a teach-in process has been started and no activity is registered at the keypad for 30 seconds after this.

8.4.2 Overview of teach-in modes

Analog outputs

LEDs		Teach-in mode	Hold
		Define measuring range (analog)	< 2 s
	2 Hz		
		Set measuring range to the maximum measuring range for the length variant	> 2 s, < 5 s
	4 Hz		
2 Hz		Switch between current and voltage output	> 5 s, < 8 s
2 Hz			
4 Hz		Invert analog output (0 V ...10 V -> 10 V ... 0 V) . (4 mA ... 20 mA -> 20 mA ... 4 mA)	> 8 s, < 11 s
4 Hz			
	2 Hz	Teach in digital switching output (see table below)	> 11 s, < 15 s, then lift finger

= lights up, = flashes, = off

Digital output

LEDs		Teach-in mode	Hold
	2 Hz	Single point (define switching point)	< 3 s
	2 Hz		
	2 Hz	Cylinder switch (define measuring range around individual measuring point)	> 3 s, < 6 s
2 Hz			
	2 Hz	Window (define measuring range)	> 6 s, < 9 s
2 Hz	2 Hz		
	2 Hz	Reset BDC1 to default values	> 9 s, < 12 s
	4 Hz		
	2 Hz	Invert switching behavior (HIGH -> LOW)	> 12 s, < 15 s
4 Hz	4 Hz		

= lights up, = flashes, = off

8.4.3 Teaching in analog outputs

8.4.3.1 Teaching in the measuring range

1. Push the piston to the start of the measuring range.
2. Press the keypad.
3. Hold the keypad for less than 2 seconds.
✓ The yellow LED flashes slowly.

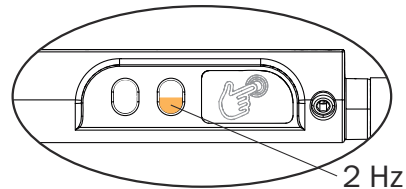

4. Lift your finger.
✓ The first measuring point is defined.

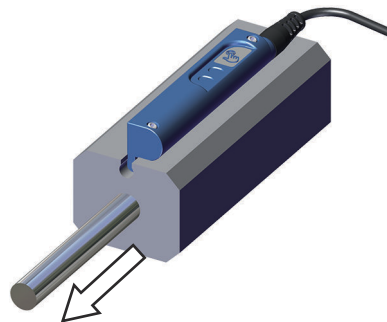

5. Push the piston to the end of the measuring range.
6. Press the keypad.
✓ The measuring range has been defined.



NOTE

The process of teaching in the measuring range may be aborted (yellow LED flashes 4 times):

- No magnet detected when teaching in the start or end of the measuring range.
 - Value below minimum measuring range (> 1 mm).
-

8.4.3.2 Resetting the measuring range

1. Press the keypad.
2. Hold the keypad between 2 and 5 seconds.
✓ The yellow LED flashes quickly.

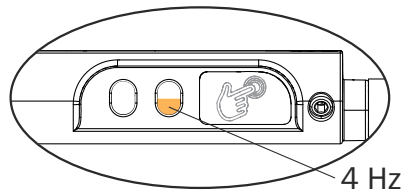

3. Lift your finger.
✓ The measuring range is reset.

8.4.3.3 Selecting the current/voltage output

1. Press the keypad.
2. Hold the keypad between 5 and 8 seconds.
- ✓ The green and blue LEDs flash slowly.

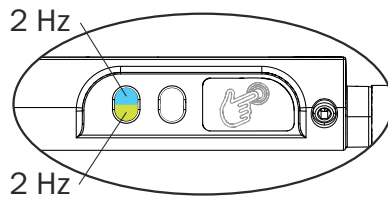

3. Lift your finger.
- ✓ The operation LED for the output currently being used flashes slowly (blue = current output, green = voltage output).
4. Press the keypad to switch the output.
- ✓ The operation LED for the newly selected output flashes slowly (blue = current output, green = voltage output).
5. Hold the keypad for around 2 seconds.
- ✓ The operation LED lights up permanently in the color of the selected output.

8.4.3.4 Inverting the analog output

1. Press the keypad.
 2. Hold the keypad between 8 and 11 seconds.
- ✓ The green and blue LEDs flash quickly.

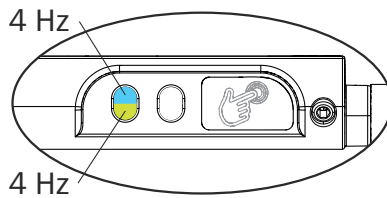

3. Lift your finger.
- ✓ The analog output supplies inverted current/voltage values.

8.4.4 Teaching in the digital switching output

8.4.4.1 Teaching in the switching point (single point mode)

1. Push the piston/magnet to the switching point.
2. Press the keypad.
3. Hold the keypad between 11 and 15 seconds.
- ✓ The blue status LED flashes slowly.

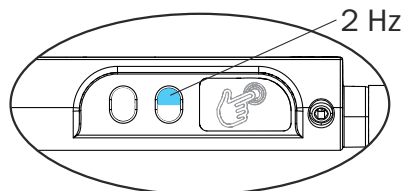

4. Lift your finger.
5. Hold the keypad for less than 3 seconds.
- ✓ The yellow and blue status LEDs flash slowly.

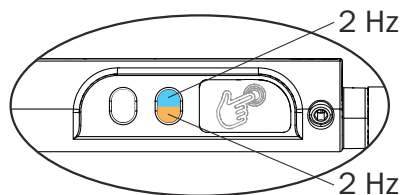

6. Lift your finger.
- ✓ The switching point is defined.

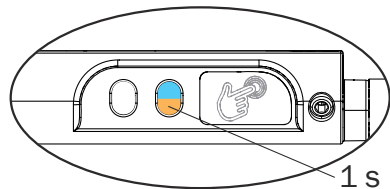

8.4.4.2 Teaching in the cylinder switch (cylinder switch mode)

1. Push the piston/magnet to the switching point.
2. Press the keypad.
3. Hold the keypad between 11 and 15 seconds.
- ✓ The blue status LED flashes slowly.

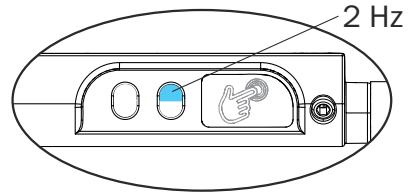

4. Lift your finger.
5. Hold the keypad between 3 and 6 seconds.
- ✓ The green operation LED and the blue status LED flash slowly.

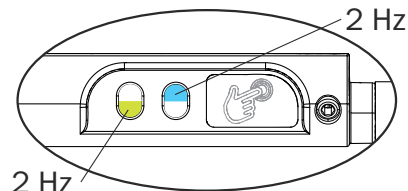

6. Lift your finger.
- ✓ The fixed switching range is defined.

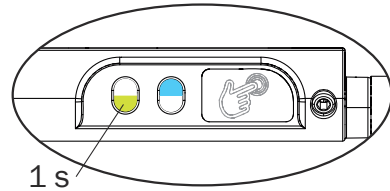

8.4.4.3 Teaching in the switching range (window mode)

1. Push the piston to the first switching point.
2. Press the keypad.
3. Hold the keypad between 11 and 15 seconds.
- ✓ The blue status LED flashes slowly.

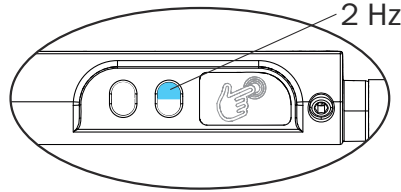

4. Lift your finger.
5. Hold the keypad between 6 and 9 seconds.
6. Lift your finger.
- ✓ The first switching point is defined. The green and yellow LEDs flash slowly.

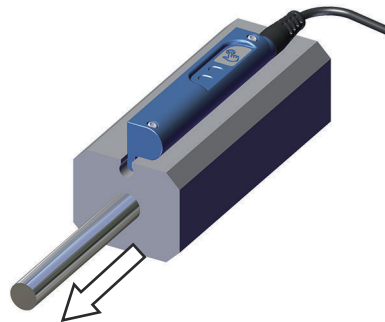
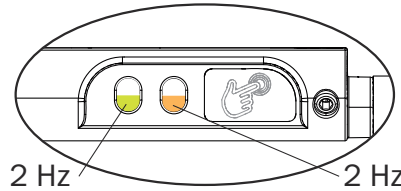

7. Push the piston to the second switching point.
8. Press the keypad.
- ✓ The second switching point is defined.

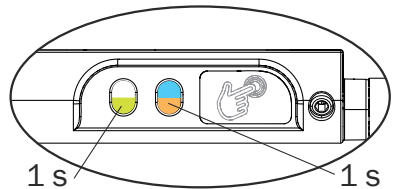

NOTE

The process of teaching in a measuring range may be aborted (yellow LED flashes 4 times):

- No magnet detected when teaching in the start or end of the measuring range.
- Value below minimum measuring range (< 1 mm).

8.4.4.4 Resetting the switching point

1. Press the keypad.
 2. Hold the keypad between 11 and 15 seconds.
- ✓ The blue status LED flashes slowly.

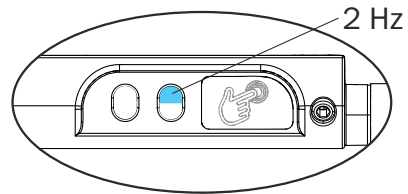

3. Lift your finger.
 4. Hold the keypad between 9 and 12 seconds.
- ✓ The blue status LED flashes slowly and the yellow status LED flashes quickly.

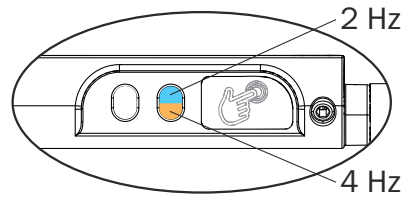

5. Lift your finger.
- ✓ The switching point is reset.

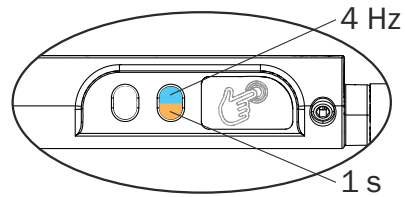

8.4.4.5 Inverting the switching behavior

1. Press the keypad.
 2. Hold the keypad between 11 and 15 seconds.
- ✓ The blue status LED flashes slowly.

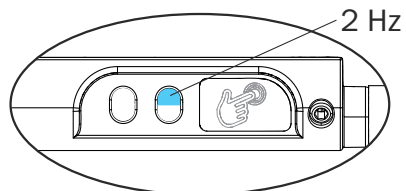

3. Lift your finger.
 4. Hold the keypad between 12 and 15 seconds.
- ✓ The green operation LED and the yellow status LED flash quickly, and the blue status LED flashes slowly.

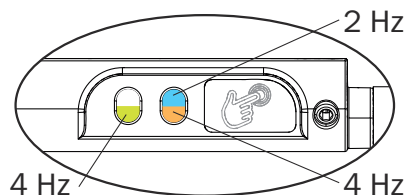

5. Lift your finger.
- ✓ The switching behavior is inverted.

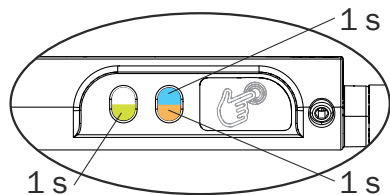

9 Maintenance

9.1 Maintenance

The sensor is maintenance-free.

To ensure it continues operating without problems, however, the screw connection between the sensor and the slot, and for the electrical connection, should be checked regularly. The interval at which they are checked should be adapted in line with the conditions of the application, but should be no more than 6 months.

9.2 Repairs

Repairs on the sensor may only be carried out by the manufacturer. Any interruption or modification of the sensor will invalidate the manufacturer warranty.

10 Decommissioning

Removing the sensor

1. Switch off the supply voltage to the sensor.
2. Detach all connecting cables from the sensor.
3. If the sensor is being replaced, mark its position and alignment on the bracket or surroundings.
4. Remove the sensor from the slot.

Disposing of the sensor

Any sensor which can no longer be used must be disposed of in an environmentally friendly manner in accordance with the applicable country-specific waste disposal regulations. The sensor is electronic waste and must under no circumstances be disposed of with general waste.

11 Technical data

11.1 Performance

Parameter	Specification
Measuring range	25 mm, ±1 mm 50 mm, ±1 mm 100 mm, ±1 mm 200 mm, ±1 mm
Field strength	3 mT ... 12 mT
Resolution	≥ 50 µm
Repeatability (at 25 °C) ¹⁾	0.1 mm
Linearity error (at 25 °C) ²⁾	0.3 mm
Sampling rate	1 ms ³⁾
Partial stroke speed, typ.	≤1.5 m/s
Full stroke speed, typ.	≤3 m/s
Time delay before availability	1.5 s

1) Repeatability with magnet movement from one direction

2) Linearity error (maximum deviation) dependent on response curve and minimum deviation function

3) Only in standard operation, not in IO-Link operation

11.2 Interfaces

Parameter	Specification
Outputs (analog)	1x current output, 1x voltage output
Output (digital)	1x digital switching output (pin 2)
IO-Link (v1.1), smart sensor profile	4 channels Data storage, block parameter BDC modes: single point mode, window mode, cylinder switch mode, two point mode Cycle time: min. 1 ms

11.3 Mechanics/electronics

Parameter	Specification
Electrical connection ¹⁾	PUR cable 0.3 m; M8, 4-pin or PUR cable 0.3 m; M12, 4-pin or PUR cable 2 m; cable outlet (open strand end)
Supply voltage (U _V)	12 ... 30 V DC, reverse polarity protected ³⁾
Residual ripple (V _{SS})	≤10%
Power consumption (without load)	P ₀ = 42 mA ²⁾ x U _V
Voltage output (analog)	0 V ... 10 V
Current output (analog)	4 mA ... 20 mA
Digital switching output	I _{max} : ±100 mA, U _{out} : 0 V ≤ U _{out} ≤ U _V - 2 V
Load resistance (current output)	≤500 Ω ⁴⁾
Load resistance (voltage output)	≥2 kΩ

Parameter	Specification
Housing	PA
Housing color	Light blue (RAL 5012)
EMC	According to EN 60947-5-7
Protection class	
Enclosure rating	IP67 (acc. to EN 60529)
Mounting	C-slot (drop-in); 2 hexagon setscrews (size 1.5); tightening torque 0.2 to 0.4 Nm; slip-proof up to 50 N
Dimensions (H/W/T)	16.8 mm x 12.2 mm x 40.6 mm 16.8 mm x 12.2 mm x 64.9 mm 16.8 mm x 12.2 mm x 114.9 mm 16.8 mm x 12.2 mm x 214.7 mm
Weight	15 g 19 g 26 g 38 g

- 1) Depending on type
- 2) Voltage output, 3 LEDs light up, no load at output
- 3) Operation in short-circuit protected network, max. 8 A.
- 4) At 24 V DC

11.4 Ambient data

Parameter	Specification
Perm. impact load	30 g/11 ms
Perm. vibration load	10 ... 55 Hz/1 mm
Perm. ambient temperature	-20 °C ... +70 °C

12 Annex

12.1 Conformities and certificates

You can obtain declarations of conformity, certificates and the current documentation for the product at www.sick.com. To do so, enter the product part number in the search field (part number: see the entry in the “P/N” or “Ident. no.” field on the type label).

Australia

Phone +61 (3) 9457 0600
1800 33 48 02 – tollfree
E-Mail sales@sick.com.au

Austria

Phone +43 (0) 2236 62288-0
E-Mail office@sick.at

Belgium/Luxembourg

Phone +32 (0) 2 466 55 66
E-Mail info@sick.be

Brazil

Phone +55 11 3215-4900
E-Mail comercial@sick.com.br

Canada

Phone +1 905.771.1444
E-Mail cs.canada@sick.com

Czech Republic

Phone +420 234 719 500
E-Mail sick@sick.cz

Chile

Phone +56 (2) 2274 7430
E-Mail chile@sick.com

China

Phone +86 20 2882 3600
E-Mail info.china@sick.net.cn

Denmark

Phone +45 45 82 64 00
E-Mail sick@sick.dk

Finland

Phone +358-9-25 15 800
E-Mail sick@sick.fi

France

Phone +33 1 64 62 35 00
E-Mail info@sick.fr

Germany

Phone +49 (0) 2 11 53 010
E-Mail info@sick.de

Greece

Phone +30 210 6825100
E-Mail office@sick.com.gr

Hong Kong

Phone +852 2153 6300
E-Mail ghk@sick.com.hk

Hungary

Phone +36 1 371 2680
E-Mail ertekesites@sick.hu

India

Phone +91-22-6119 8900
E-Mail info@sick-india.com

Israel

Phone +972 97110 11
E-Mail info@sick-sensors.com

Italy

Phone +39 02 27 43 41
E-Mail info@sick.it

Japan

Phone +81 3 5309 2112
E-Mail support@sick.jp

Malaysia

Phone +603-8080 7425
E-Mail enquiry.my@sick.com

Mexico

Phone +52 (472) 748 9451
E-Mail mexico@sick.com

Netherlands

Phone +31 (0) 30 229 25 44
E-Mail info@sick.nl

New Zealand

Phone +64 9 415 0459
0800 222 278 – tollfree
E-Mail sales@sick.co.nz

Norway

Phone +47 67 81 50 00
E-Mail sick@sick.no

Poland

Phone +48 22 539 41 00
E-Mail info@sick.pl

Romania

Phone +40 356-17 11 20
E-Mail office@sick.ro

Russia

Phone +7 495 283 09 90
E-Mail info@sick.ru

Singapore

Phone +65 6744 3732
E-Mail sales.gsg@sick.com

Slovakia

Phone +421 482 901 201
E-Mail mail@sick-sk.sk

Slovenia

Phone +386 591 78849
E-Mail office@sick.si

South Africa

Phone +27 10 060 0550
E-Mail info@sickautomation.co.za

South Korea

Phone +82 2 786 6321/4
E-Mail infokorea@sick.com

Spain

Phone +34 93 480 31 00
E-Mail info@sick.es

Sweden

Phone +46 10 110 10 00
E-Mail info@sick.se

Switzerland

Phone +41 41 619 29 39
E-Mail contact@sick.ch

Taiwan

Phone +886-2-2375-6288
E-Mail sales@sick.com.tw

Thailand

Phone +66 2 645 0009
E-Mail marcom.th@sick.com

Turkey

Phone +90 (216) 528 50 00
E-Mail info@sick.com.tr

United Arab Emirates

Phone +971 (0) 4 88 65 878
E-Mail contact@sick.ae

United Kingdom

Phone +44 (0)17278 31121
E-Mail info@sick.co.uk

USA

Phone +1 800.325.7425
E-Mail info@sick.com

Vietnam

Phone +65 6744 3732
E-Mail sales.gsg@sick.com

Detailed addresses and further locations at www.sick.com