

microScan3 Core I/O

Safety laser scanners

SICK
Sensor Intelligence.



Described product

microScan3 Core I/O

Manufacturer

SICK AG
Erwin-Sick-Str. 1
79183 Waldkirch
Germany

Legal information

This work is protected by copyright. Any rights derived from the copyright shall be reserved for SICK AG. Reproduction of this document or parts of this document is only permissible within the limits of the legal determination of Copyright Law. Any modification, abridgment or translation of this document is prohibited without the express written permission of SICK AG.

The trademarks stated in this document are the property of their respective owner.

© SICK AG. All rights reserved.

Original document

This document is an original document of SICK AG.



Contents

1	About this document.....	8
1.1	Function of this document.....	8
1.2	Scope.....	8
1.3	Target groups of these operating instructions.....	8
1.4	Further information.....	8
1.5	Symbols and document conventions.....	9
2	Safety information.....	10
2.1	General safety notes.....	10
2.2	Intended use.....	11
2.3	Inappropriate use.....	11
2.4	Cybersecurity.....	12
2.5	Requirements for the qualification of personnel.....	12
3	Product description.....	13
3.1	Product identification via the SICK product ID.....	13
3.2	Device overview.....	13
3.3	Setup and function.....	14
3.4	Product characteristics.....	15
3.4.1	Variants.....	15
3.4.2	Connections.....	16
3.4.3	System plug.....	17
3.4.4	Field types.....	17
3.4.5	Field set.....	19
3.4.6	Monitoring case.....	20
3.5	Example applications.....	21
4	Project planning.....	24
4.1	Manufacturer of the machine.....	24
4.2	Operator of the machine.....	24
4.3	Assembly.....	25
4.3.1	Protection from influences.....	26
4.3.2	Preventing unprotected areas.....	27
4.3.3	Response time of the safety laser scanner.....	29
4.3.4	Reference contour monitoring.....	29
4.3.5	Monitoring case switching time.....	31
4.3.6	Hazardous area protection.....	33
4.3.7	Hazardous point protection.....	40
4.3.8	Access protection.....	43
4.3.9	Mobile hazardous area protection.....	46
4.4	Integration in the electrical control system.....	51
4.4.1	Electromagnetic compatibility.....	53
4.4.2	Voltage supply.....	53
4.4.3	USB connection.....	54

4.4.4	OSSDs.....	54
4.4.5	Control inputs.....	55
4.4.6	Universal inputs, universal outputs, universal I/Os.....	57
4.4.7	Restart interlock.....	57
4.4.8	External device monitoring (EDM).....	61
4.4.9	Connection diagrams.....	61
4.5	Testing plan.....	61
4.5.1	Planning the thorough check during commissioning and in certain situations.....	62
4.5.2	Planning the regular thorough check.....	62
4.5.3	Notes on the tests.....	63
5	Mounting.....	66
5.1	Safety.....	66
5.2	Unpacking.....	66
5.3	Mounting procedure.....	67
5.3.1	Direct mounting.....	68
6	Electrical installation.....	69
6.1	Safety.....	69
6.2	Connection overview.....	70
6.2.1	microScan3 Core.....	71
6.3	Pin assignment.....	71
6.3.1	Connecting cable with M12 plug connector.....	71
7	Configuration.....	72
7.1	Delivery state.....	72
7.2	Safety Designer configuration software.....	72
7.2.1	Installing Safety Designer.....	72
7.2.2	Projects.....	72
7.2.3	User interface.....	74
7.2.4	User groups.....	74
7.2.5	Settings.....	76
7.2.6	Configuration.....	76
7.2.7	Networking.....	78
7.3	Overview.....	79
7.3.1	Functional scope.....	80
7.4	Reading configuration.....	81
7.5	Identification.....	82
7.6	Application.....	83
7.7	Monitoring plane.....	85
7.7.1	Parameters for the monitoring plane.....	85
7.7.2	Parameters for the safety laser scanner.....	88
7.8	Reference contour field.....	90
7.9	Fields.....	91
7.9.1	Using the field editor.....	92

7.9.2	Creating field set templates.....	95
7.9.3	Importing and exporting field sets and fields.....	96
7.9.4	Background image.....	96
7.9.5	Settings for the field editor.....	97
7.9.6	Editing fields using coordinates.....	98
7.9.7	Drawing in points that cannot be monitored.....	99
7.9.8	Defining global geometry.....	100
7.9.9	Enable propose field.....	100
7.10	Inputs and outputs, local.....	102
7.10.1	Outputs.....	103
7.10.2	Inputs.....	103
7.10.3	Further settings for some signals.....	104
7.11	Monitoring cases.....	106
7.11.1	Settings for monitoring case tables.....	106
7.11.2	Settings for monitoring cases.....	107
7.11.3	Input condition.....	107
7.11.4	Cut-off paths.....	108
7.11.5	Assigning field sets.....	108
7.11.6	Assigning a defined cut-off behavior.....	108
7.11.7	Importing and exporting monitoring case tables.....	109
7.12	Simulation.....	110
7.13	Transfer.....	111
7.14	Starting and stopping safety function.....	112
7.15	Reports.....	113
7.16	Service.....	114
7.16.1	Device restart.....	114
7.16.2	Factory settings.....	114
7.16.3	Managing passwords.....	115
7.16.4	Access management.....	116
7.16.5	Optics cover calibration.....	116
7.16.6	Compare configuration.....	117
8	Commissioning.....	119
8.1	Safety.....	119
8.2	Alignment.....	119
8.3	Switching on.....	120
8.4	Check during commissioning and modifications.....	121
9	Operation.....	122
9.1	Safety.....	122
9.2	Regular thorough check.....	122
9.3	Status indicators.....	122
9.3.1	Status LEDs.....	122
9.3.2	Status indicator with the display.....	123
10	Maintenance.....	126

10.1	Safety.....	126
10.2	Regular cleaning.....	126
10.3	Replacing the optics cover.....	127
10.4	Replacing the safety laser scanner.....	129
10.4.1	Replacing the safety laser scanner without system plug.....	130
10.4.2	Replacing the safety laser scanner completely.....	131
10.5	Replacing the system plug.....	131
10.6	Regular thorough check.....	132
11	Troubleshooting.....	133
11.1	Safety.....	133
11.2	Detailed diagnostics using the display.....	133
11.3	Error indication on the display.....	135
11.4	Diagnostics using Safety Designer.....	137
11.4.1	Data recorder.....	137
11.4.2	Event history.....	139
11.4.3	Message history.....	141
12	Decommissioning.....	142
12.1	Disposal.....	142
13	Technical data.....	143
13.1	Variant overview.....	143
13.2	Version numbers and functional scope.....	143
13.3	Data sheet.....	144
13.3.1	microScan3 Core I/O.....	144
13.4	Response times.....	151
13.5	Course of the OSSD test over time.....	152
13.6	Sensing range.....	153
13.7	Dimensional drawings.....	157
14	Ordering information.....	158
14.1	Scope of delivery.....	158
14.2	Ordering information.....	158
15	Spare parts.....	159
15.1	Safety laser scanner without system plug.....	159
15.2	System plug.....	159
15.3	Additional spare parts.....	159
16	Accessories.....	160
16.1	Additional accessories.....	160
17	Glossary.....	161
18	Annex.....	165
18.1	Conformities and certificates.....	165

18.1.1	EU declaration of conformity.....	165
18.1.2	UK declaration of conformity.....	165
18.2	Note on standards.....	165
18.3	Checklist for initial commissioning and commissioning.....	167
18.4	Mounting methods for protection from interference from systems in close proximity.....	168
19	List of figures.....	171
20	List of tables.....	173

1 About this document

1.1 Function of this document

These operating instructions contain the information needed during the life cycle of the safety laser scanner.

Operating instructions of the safety laser scanner must be made available to all people who work with the device.

Read the operating instructions carefully and ensure that you have understood the contents completely before you work with the safety laser scanner.

1.2 Scope

Product

This document applies to the following products:

- Product code: microScan3 Core I/O
- "Operating instructions" type label entry: 8016344

Document identification

Document part number:

- This document: 8016346
- Available language versions of this document: 8016344

You can find the current version of all documents at www.sick.com.

1.3 Target groups of these operating instructions

Some sections of these operating instructions are intended for certain target groups. However, the entire operating instructions are relevant for intended use of the product.

Table 1: Target groups and selected sections of these operating instructions

Target group	Sections of these operating instructions
Project developers (planners, developers, designers)	"Project planning", page 24 "Configuration", page 72 "Technical data", page 143 "Accessories", page 160
Installers	"Mounting", page 66
Electricians	"Electrical installation", page 69
Safety experts (such as CE authorized representatives, compliance officers, people who test and approve the application)	"Project planning", page 24 "Configuration", page 72 "Commissioning", page 119 "Technical data", page 143 "Checklist for initial commissioning and commissioning", page 167
Operators	"Operation", page 122 "Troubleshooting", page 133
Maintenance personnel	"Maintenance", page 126 "Troubleshooting", page 133

1.4 Further information

www.sick.com

The following information is available via the Internet:

- Data sheets and application examples
- CAD files and dimensional drawings
- Certificates (such as the EU declaration of conformity)
- Guide for Safe Machinery. Six steps to a safe machine
- Safety Designer (software for configuring safety solutions made by SICK AG)

1.5 Symbols and document conventions

The following symbols and conventions are used in this document:

Warnings and other notes



DANGER

Indicates a situation presenting imminent danger, which will lead to death or serious injuries if not prevented.



WARNING

Indicates a situation presenting possible danger, which may lead to death or serious injuries if not prevented.



CAUTION

Indicates a situation presenting possible danger, which may lead to moderate or minor injuries if not prevented.



NOTICE

Indicates a situation presenting possible danger, which may lead to property damage if not prevented.



NOTE

Highlights useful tips and recommendations as well as information for efficient and trouble-free operation.

Instructions to action

- ▶ The arrow denotes instructions to action.
- 1. The sequence of instructions for action is numbered.
- 2. Follow the order in which the numbered instructions are given.
- ✓ The check mark denotes the result of an instruction.

LED symbols

These symbols indicate the status of an LED:

- The LED is off.
- ◐ The LED is flashing.
- The LED is illuminated continuously.

2 Safety information

2.1 General safety notes

Overview

This section contains general safety information about the safety laser scanner.

Further information about specific product use situations can be found in the relevant chapters.

Integrating the product



DANGER

The product can not offer the expected protection if it is integrated incorrectly.

- ▶ Plan the integration of the product in accordance with the machine requirements (project planning).
- ▶ Implement the integration of the product in accordance with the project planning.

Laser class 1M



WARNING

Invisible laser radiation

Laser class 1M

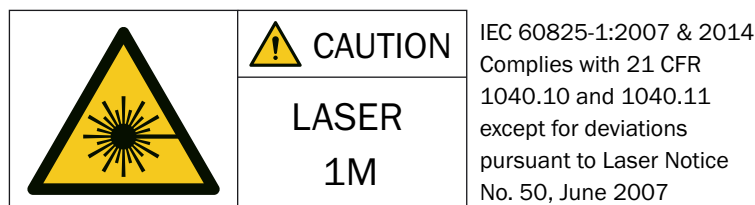

Figure 1: Laser class 1M

This device complies with the following standards:

- IEC 60825-1:2007/EN 60825-1:2007
- IEC 60825-1:2014/EN 60825-1:2014
- 21 CFR 1040.10 and 1040.11, except for changes due to Laser Notice No. 50 of 24/06/2007

The accessible laser of the safety laser scanner is not hazardous as long as the beam cross section is not reduced by optical instruments, such as magnifying glasses, lenses, telescopes.

The curved part of the optics cover is the outlet for the laser radiation.

The laser marking is located on the underside of the safety laser scanner.

- ▶ You must comply with the latest version of the applicable laser safety regulations.



CAUTION

If any operating or adjusting devices other than those specified in this document are used or other methods are employed, this can lead to dangerous exposure to radiation.

- ▶ Only use the operating or adjusting devices specified in this document.
- ▶ Only follow the methods specified in this document.
- ▶ Do not open the housing, except for the purposes of the installation and maintenance work specified in these operating instructions.

**CAUTION**

Observing the safety laser scanner through optical instruments (such as magnifying glasses, lenses, telescopes) may be hazardous for the eyes.

- ▶ Do not look directly at the laser beam source using optical instruments.

Mounting and electrical installation**DANGER**

Death or severe injury due to electrical voltage and/or an unexpected startup of the machine

- ▶ Make sure that the machine is (and remains) disconnected from the voltage supply during mounting and electrical installation.
- ▶ Make sure that the dangerous state of the machine is and remains switched off.

Repairs and modifications**DANGER**

Improper work on the product

A modified product may not offer the expected protection if it is integrated incorrectly.

- ▶ Apart from the procedures described in this document, do not repair, open, manipulate or otherwise modify the product.

2.2 Intended use

The safety laser scanner is an electro-sensitive protective device (ESPE) and is suitable for the following applications:

- Hazardous area protection
- Hazardous point protection
- Access protection
- Mobile hazardous area protection (e.g. protection from automated guided vehicles)

The product may be used in safety functions.

The safety laser scanner must only be used within the limits of the prescribed and specified technical data and operating conditions at all times.

Incorrect use, improper modification or manipulation of the safety laser scanner will invalidate any warranty from SICK; in addition, any responsibility and liability of SICK for damage and secondary damage caused by this is excluded.

2.3 Inappropriate use

**DANGER**

Hazard due to lack of effectiveness of the protective device

Persons and parts of the body to be protected may not be recognized in case of non-observance.

The safety laser scanner works as an indirect protective measure and cannot provide protection from pieces thrown from the application nor from emitted radiation. Transparent objects are not detected.

- ▶ You must only use the safety laser scanner as an indirect protective measure.

The safety laser scanner is not suitable for the following applications, among others:

- Outdoors
- Underwater
- In explosion-hazardous areas

2.4 Cybersecurity

Overview

To protect against cybersecurity threats, it is necessary to continuously monitor and maintain a comprehensive cybersecurity concept. A suitable concept consists of organizational, technical, procedural, electronic, and physical levels of defense and considers suitable measures for different types of risks. The measures implemented in this product can only support protection against cybersecurity threats if the product is used as part of such a concept.

You will find further information at www.sick.com/psirt, e.g.:

- General information on cybersecurity
- Contact option for reporting vulnerabilities
- Information on known vulnerabilities (security advisories)

Communication interfaces

- USB
- Display and pushbuttons

Further topics

- ["Managing passwords", page 115](#)
- ["Access management", page 116](#)

2.5 Requirements for the qualification of personnel

The product must be configured, installed, connected, commissioned, and serviced by qualified safety personnel only.

Project planning

You need safety expertise to implement safety functions and select suitable products for that purpose. You need expert knowledge of the applicable standards and regulations.

Mounting, electrical installation and commissioning

You need suitable expertise and experience. You must be able to assess if the machine is operating safely.

Configuration

You need suitable expertise and experience. You must be able to assess if the machine is operating safely.

Operation and maintenance

You need suitable expertise and experience. You must be instructed in machine operation by the machine operator. For maintenance, you must be able to assess if the machine is operating safely.

3 Product description

3.1 Product identification via the SICK product ID

SICK product ID

The SICK product ID uniquely identifies the product. It also serves as the address of the web page with information on the product.

The SICK product ID comprises the host name pid.sick.com, the part number (P/N), and the serial number (S/N), each separated by a forward slash.

For newer products, the SICK product ID is displayed as text and QR code on the type label and/or on the packaging.



Figure 2: SICK product ID

3.2 Device overview

Overview

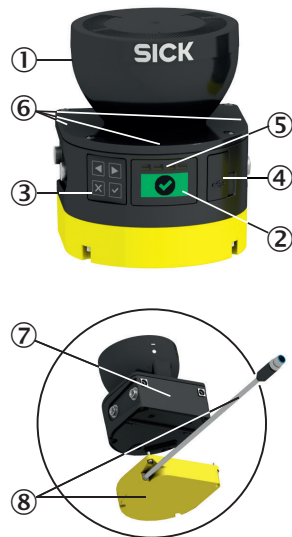

Figure 3: Device overview

- ① Optics cover
- ② Display
- ③ Keypad
- ④ USB connection
- ⑤ Status LEDs
- ⑥ Additional LEDs for ON state and OFF state
- ⑦ Safety laser scanner without system plug
- ⑧ System plug

Complementary information

The safety laser scanner can be mounted and operated in any orientation.

Position and direction information in this document:

- The top is the side of the safety laser scanner on which the optics cover is located.
- The bottom is the side of the safety laser scanner opposite the optics cover.
- The front is the side of the safety laser scanner on which the display is located. The 90° angle of the sector of a circle scanned by the safety laser scanner points in this direction.
- The back is the side of the safety laser scanner opposite the display. The sector of a circle not scanned by the safety laser scanner lies in this direction.

Further topics

- ["Connections", page 16](#)
- ["Status indicators", page 122](#)

3.3 Setup and function

The safety laser scanner is an electro-sensitive protective device (ESPE) which scans its surroundings two-dimensionally using infrared laser beams.

The safety laser scanner forms a protective field using the invisible laser beams. This protective field protects the hazardous area and enables hazardous point protection, access protection or hazardous area protection. As soon as an object is situated in the protective field, the safety laser scanner signals the detection by means of a signal change at the safety output (OSSD for example). The machine or its control must safely analyze the signals (for example using a safe control or safety relays) and stop the dangerous state.

The safety laser scanner operates on the principle of optical time-of-flight measurement. It emits light pulses in regular, very short intervals. If the light strikes an object, it is reflected. The safety laser scanner receives the reflected light. The safety laser scanner calculates the distance to the object based on the time interval between the moment of transmission and moment of receipt (Δt).

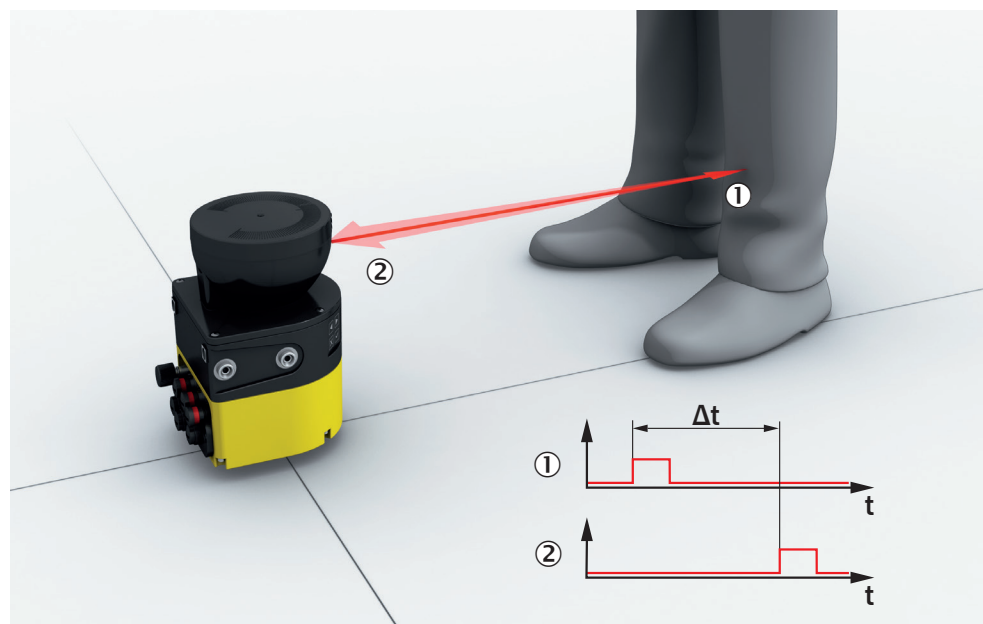

Figure 4: Principle of time-of-flight measurement

- ① Transmitted light pulse
- ② Reflected light pulse

A rotating mirror is situated in the safety laser scanner. The mirror deflects the light pulses so that they scan a fan-shaped area.

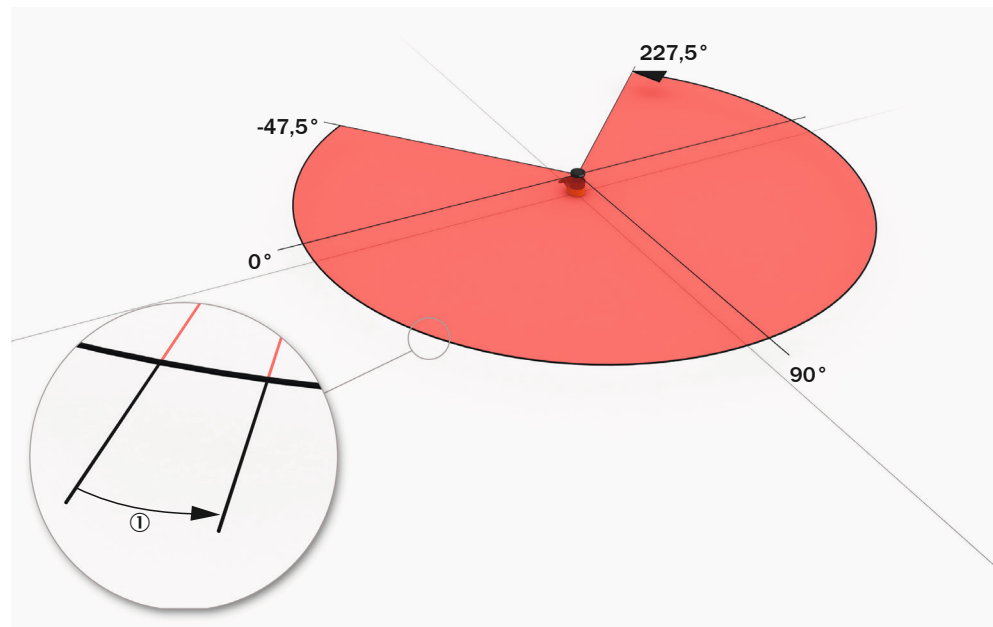

Figure 5: Light pulses scan an area

- ① Angular resolution: the angular distance (in degrees) between 2 distance measurements

Scan cycle time and resolution

The time that the mirror requires for one rotation is called the scan cycle time. The number of light pulses per unit of time is constant. The scan cycle time and the number of light pulses per unit of time determine the angular resolution. The scanning range for a given object resolution depends on the angular resolution. The object resolution indicates the minimum size that an object must be to allow it to be detected safely. The scan cycle time also influences the response time.

Slightly different scan cycle times can be used to minimize mutual interference in neighboring safety laser scanners.

The resolution in protective fields can be set to various values according to the intended purpose.

Geometry of the scan plane

The laser beams emitted cover a sector of a circle, so an object can be detected in an area of up to 275°.

The sector of a circle covered ranges from -47.5° to 227.5° , where 90° denotes the axis of the safety laser scanner from the back to the front. When viewing the safety laser scanner from above, the direction of rotation of the mirror and the deflected light pulses is counterclockwise, [see figure 5](#).

3.4 Product characteristics

3.4.1 Variants

The safety laser scanner is delivered in different variants. You will find an overview of important distinguishing features of the variants in the following.

Performance package

The Core performance package is characterized by the number of configurable fields and the number of safety switching functions (OSSD pairs).

- microScan3 core I/O: 8 fields; safety output: 1 OSSD pair

Integration in the control

The safety laser scanner communicates with the machine controller as follows:

- I/O: local inputs and outputs (incl. OSSDs)

Protective field range

The safety laser scanner is available in variants with the following maximum protective field range:

- 4.0 m
- 5.5 m
- 9.0 m

Further topics

- ["Variant overview", page 143](#)

3.4.2 Connections

- 1 × connecting cable with male connector, M12, A-coded for voltage supply, OSSDs and universal I/Os (can be used as universal input, universal output or in pairs as static control input)
- 1 × female connector, USB 2.0 Mini-B for configuration and diagnosis ¹⁾

OSSD

An OSSD is a safety switching output. The functionality of each OSSD is tested periodically. OSSDs are always connected in pairs and must undergo dual-channel analysis for safety reasons. An OSSD pair is formed from 2 OSSDs that are connected and analyzed together.

Control input

A control input receives signals, e.g. from the machine or from the control. Use of control inputs is how the protective device receives information about the conditions at the machine, e.g., if there is a change of operating mode. If the protective device is configured appropriately, it will activate a different monitoring case after receiving a new control input.

The control input information must be transmitted reliably. Generally, at least 2 separate channels are used to do this.

A static control input is a dual-channel control input, which evaluates the status of every channel as the value 0 or 1. The signal states of one or more static control inputs give a unique signal pattern. This signal pattern activates a monitoring case.

Universal I/O

Universal I/O can be configured as universal input or as universal output.

Universal input

Depending on the device, a universal input can be used for resetting, external device monitoring (EDM), sleep mode, or restarting the protective device, for example. If sleep mode is activated by a universal input, the sleep mode must not be used for safety applications. Certain universal inputs can also be used in pairs as a static control input.

Universal output

The function of a universal output is configurable. Which functions are available depends on the device. Possible signals are, for example: reset required, contamination warning.

¹⁾ The USB connection may only be used temporarily and only for configuration and diagnostics.

A universal output must not be used for safety functions.

3.4.3 System plug

A system plug is required to operate the safety laser scanner.

The base plate is the system plug (see figure 3, page 13).

The safety laser scanner's internal configuration memory is integrated in the system plug. The system plug and all connecting cables can remain at the installation site when the safety laser scanner is replaced. The system plug is detached from the defective safety laser scanner and connected to the new safety laser scanner. The new safety laser scanner reads the configuration from the configuration memory when switched on.

3.4.4 Field types

During operation, the safety laser scanner uses its laser beams to continuously check whether people or objects are present in one or more areas. The areas to be checked are called fields. A distinction is made between the following field types, depending on the application type:

- Protective field
- Reference contour field
- Contour detection field
- Warning field

Table 2: Field types and their function

	Protective field	Reference contour field	Contour detection field	Warning field
Safe switch off (according to ISO 13849-1)	Yes (PL d)	Yes (PL d)	Yes (PL d)	No
Max. scanning range of the safety laser scanner	Variant-dependent: 4.0 m 5.5 m 9.0 m	Variant-dependent: 4.0 m 5.5 m 9.0 m	Variant-dependent: 4.0 m 5.5 m 9.0 m	Variant-dependent: 40 m 64 m
Purpose	Detection and protection of people	Tamper protection	e.g. door monitoring	Functional use (no safety-relevant use)

Protective field

The protective field is the area in which the test object specified by the manufacturer is detected by the electro-sensitive protective equipment (ESPE). As soon as the electro-sensitive protective device detects an object in the protective field, it switches the associated safety outputs to the OFF state. This signal can be passed to controllers resulting in the dangerous state coming to an end, e.g. to stop the machine or the vehicle.

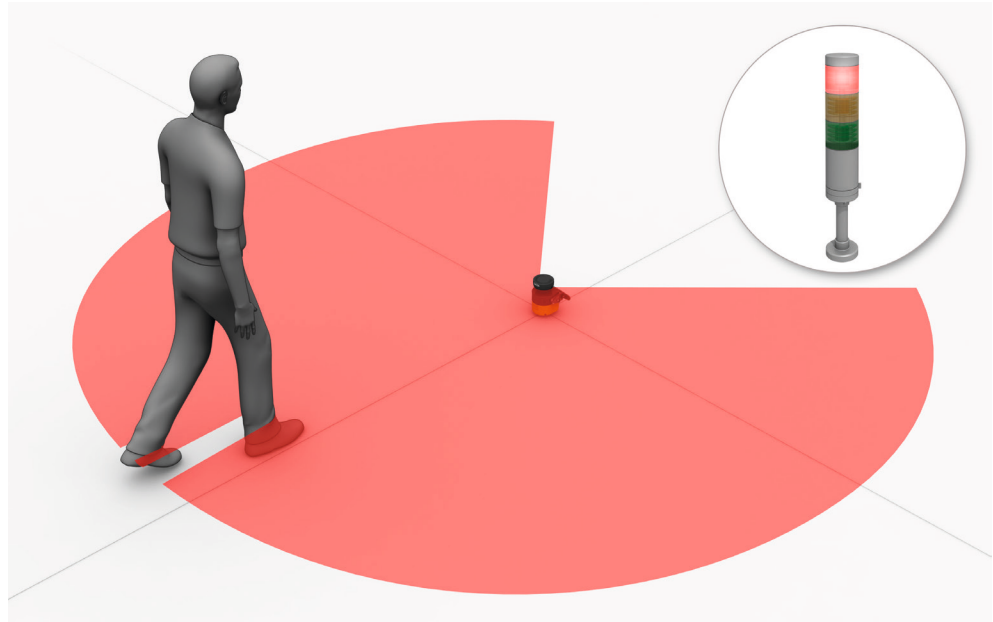

Figure 6: Protective field, shown in red in this document

Reference contour field

The contour as reference field monitors a contour of the environment. The safety laser scanner switches all safety outputs to the OFF state if a contour does not match the set parameters, because, for example, the mounting of the safety laser scanner has been changed.

National and international standards require or recommend that a reference contour is monitored, if the safety laser scanner is used in vertical operation for hazardous point protection or for access protection.

The reference contour field detects unintentional and intentional changes to the position or alignment of the safety laser scanner. Unintentional changes may be caused by vibrations for example. An example of an intentional change is deliberate tampering to disable the functionality of the safety laser scanner.

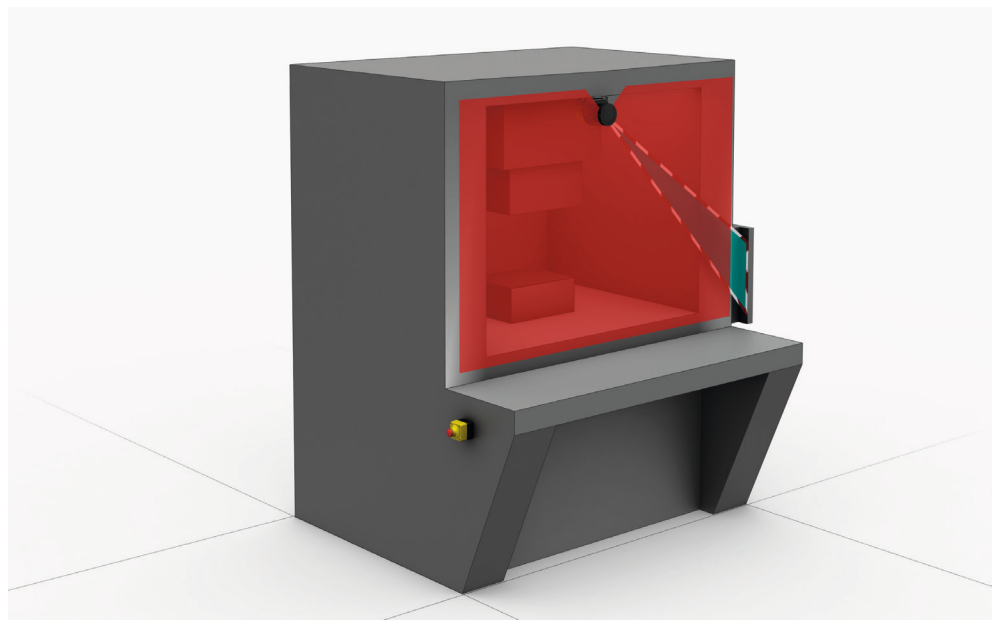

Figure 7: Reference contour field, shown in blue-green in this document

Contour detection field

The contour detection field monitors a contour of the environment. The electro-sensitive protective device switches the associated safety outputs to the OFF state if a contour does not correspond to the set specifications, e.g. because a door or flap is open.

The contour detection field is used for detecting changes in the environment and only switches the outputs in the current monitoring case. By contrast, the reference contour field is used for detecting changes at the safety laser scanner and switches all safety outputs.

Warning field

The warning field monitors larger areas than the protective field. Simple switching functions can be triggered with the warning field, e.g. a warning light or an acoustic signal can be triggered if a person approaches, even before the person enters the protective field.

The warning field must not be used for safety applications.

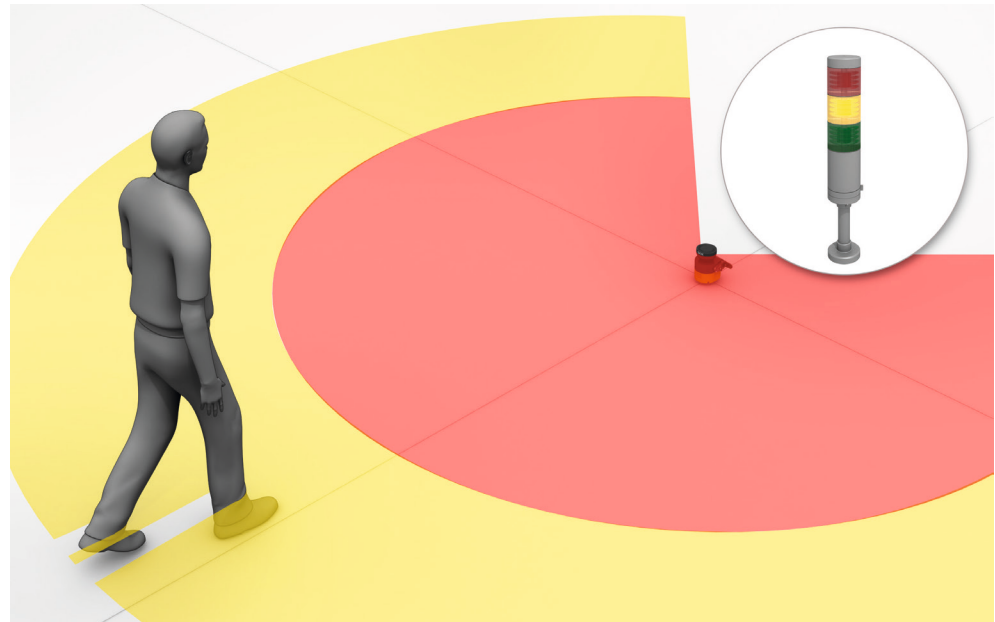

Figure 8: Warning field, shown in yellow or orange in this document

3.4.5 Field set

A field set consists of one or more fields. The fields in a field set are monitored simultaneously.

A field set can contain different field types, e.g., a protective field and a warning field.

A typical application is the use of a protective field with one or more warning fields: if a vehicle approaches a person, a warning field triggers an optical or acoustic signal. If the person does not react to this and the vehicle continues to approach, the safety laser scanner detects an object in the protective field and switches the associated safety outputs to the OFF state. The vehicle stops before it reaches the person.

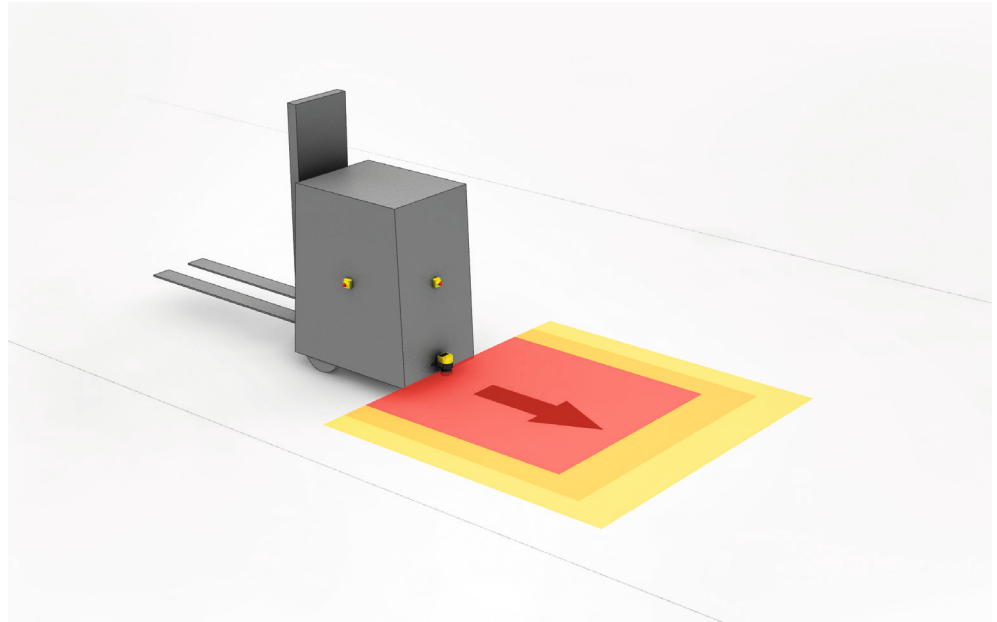

Figure 9: Field set, consisting of one protective field (red) and 2 warning fields (orange and yellow)

3.4.6 Monitoring case

A monitoring case signals the machine status to the safety laser scanner. The safety laser scanner activates the field set, which is assigned to the monitoring case and therefore a particular machine status.

If a machine, e.g., has various operational statuses, a monitoring case can be assigned to each operational status. The safety laser scanner receives a defined signal for the current operational status via the control inputs. If there is a change of signal, the safety laser scanner switches from one monitoring case to the monitoring case that is assigned to the new signal (as well as the new operational status). Generally, one field set is assigned to each monitoring case.

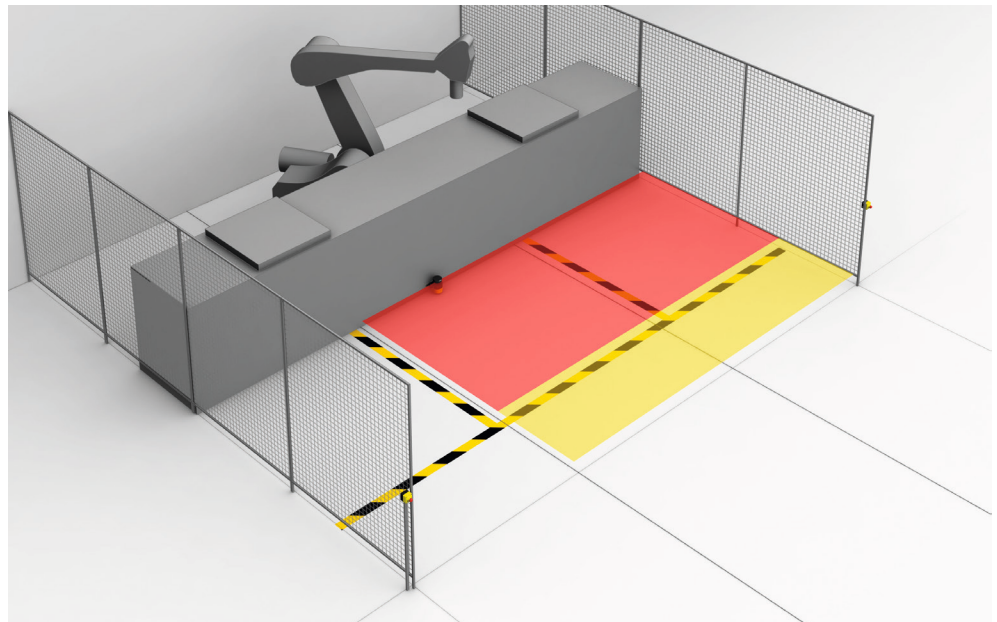

Figure 10: Monitoring case 1 with field set 1

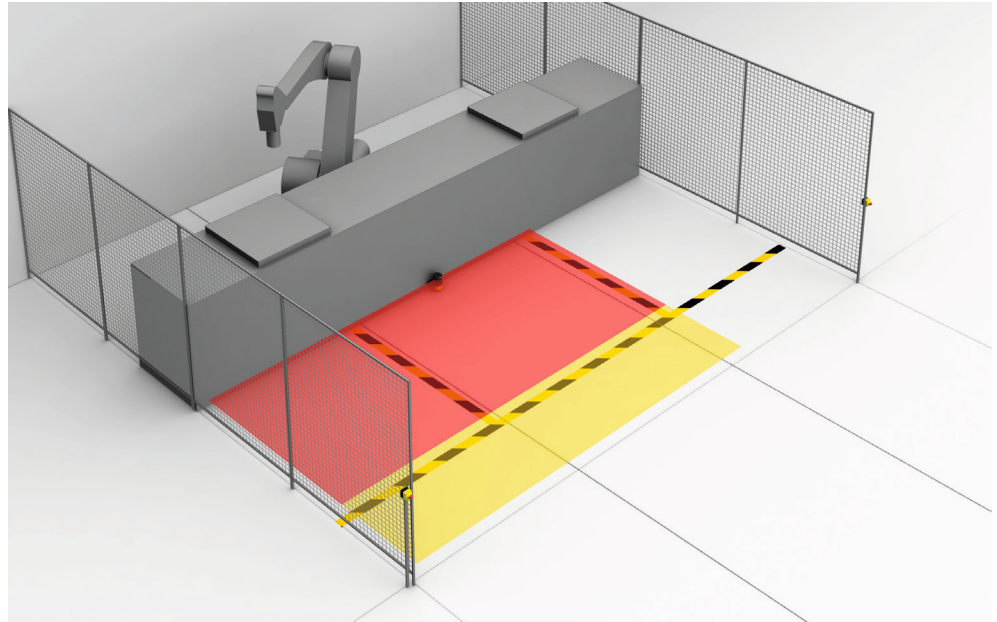

Figure 11: Monitoring case 2 with field set 2

3.5 Example applications

Hazardous area protection

In hazardous area protection, people are detected if they stay in a defined area.

This type of protective device is suitable for machines, where it is possible to see a hazardous area completely from the reset pushbutton. When the hazardous area is entered, a stop signal is triggered and starting is prevented.

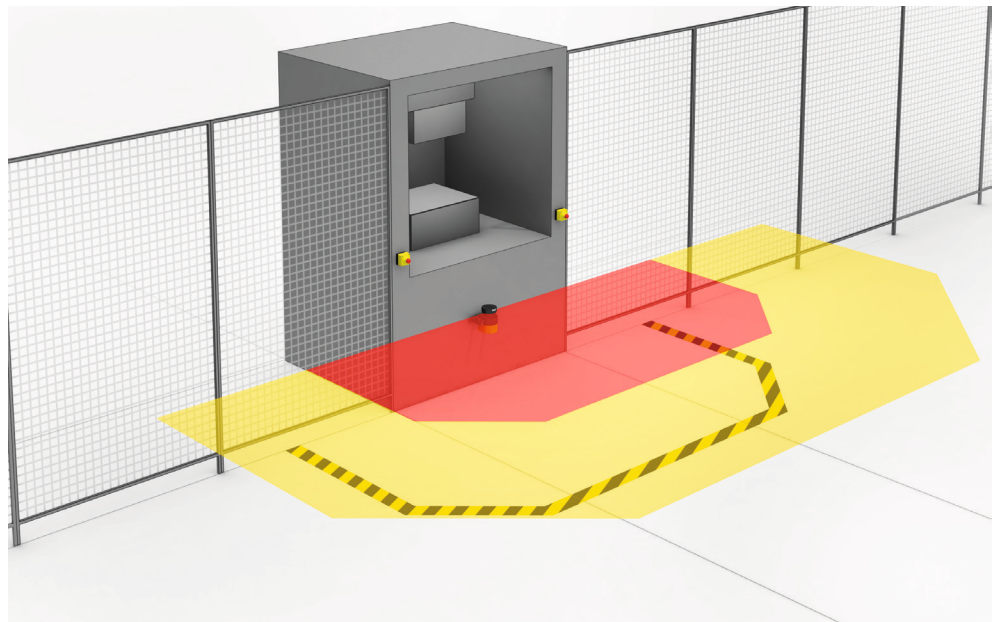

Figure 12: Hazardous area protection: detection of the presence of a person in the hazardous area

Hazardous point protection

In hazardous point protection, the approach is detected very close to the hazardous point.

The advantage of this type of protective device is that it is possible to have a short minimum distance and the operator can work more ergonomically.

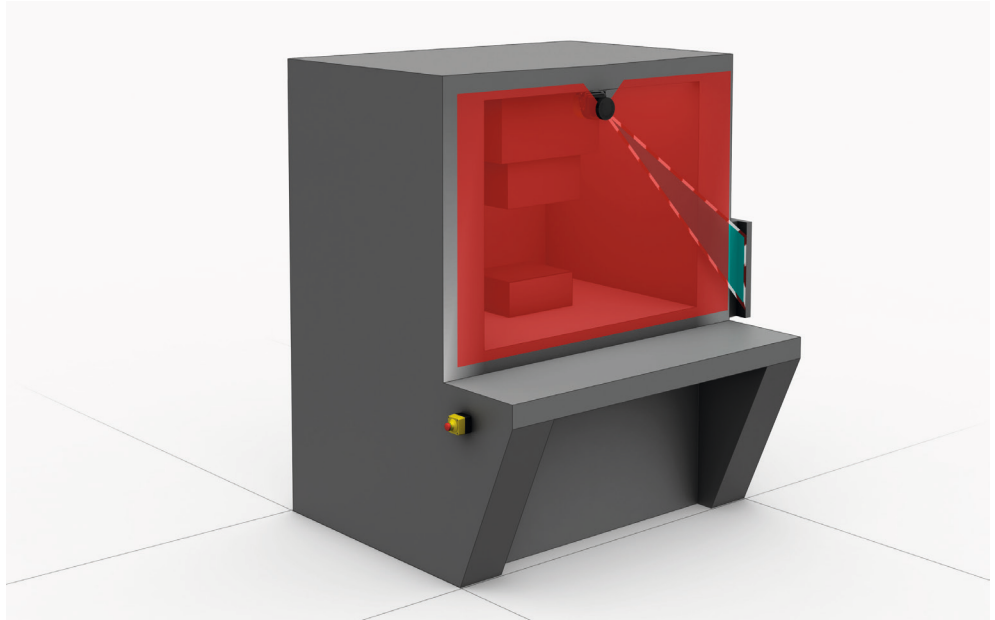

Figure 13: Hazardous point protection: Hand detection

Access protection

In access protection, people are detected if their whole body passes through the protective field.

This type of protective device is used for the protection of access to hazardous areas. When the hazardous area is entered, a stop signal is triggered. A person standing behind the protective device will not be detected by the ESPE.

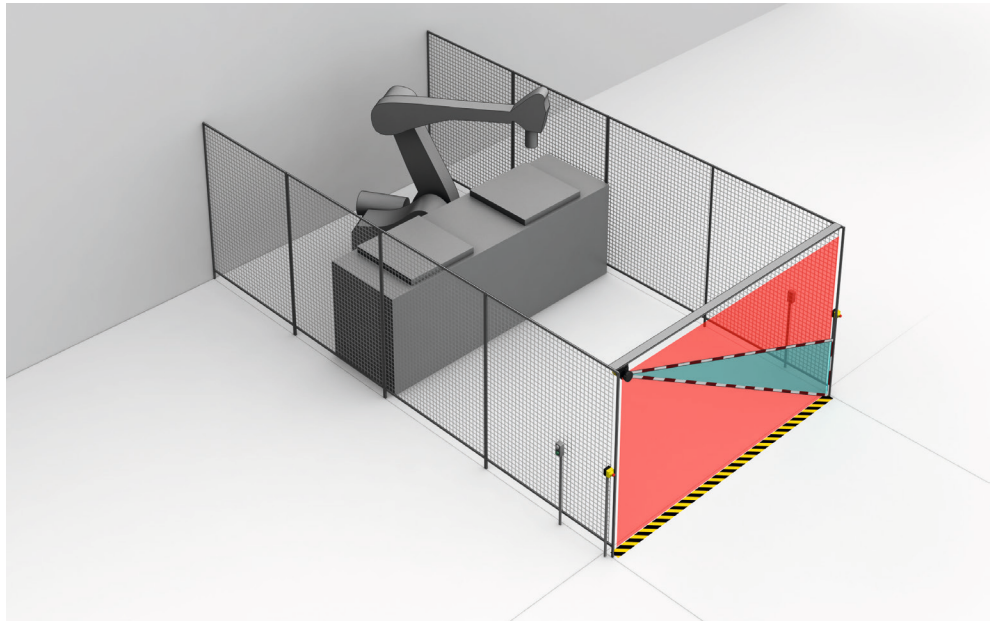

Figure 14: Access protection: detection of a person when accessing a hazardous area

Mobile hazardous area protection

Mobile hazardous area protection is suitable for AGVs (automated guided vehicles), cranes, and forklift trucks to protect people when vehicles are moving or docking at a fixed station.

The safety laser scanner monitors the area in the direction of travel and stops the vehicle as soon as an object is located in the protective field.

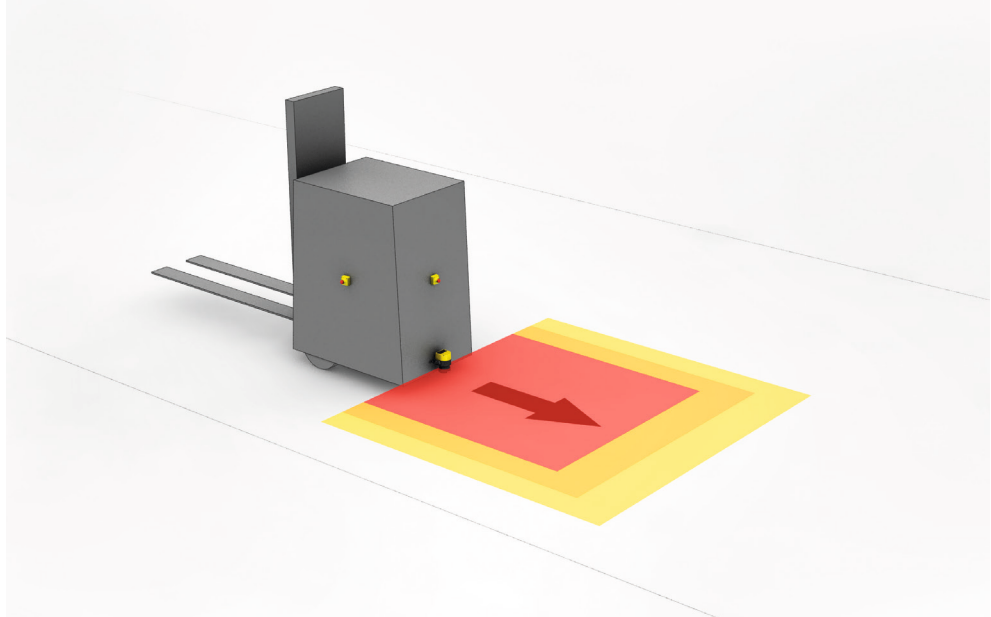

Figure 15: Mobile hazardous area protection: detection of a person when a vehicle approaches

4 Project planning

4.1 Manufacturer of the machine

**DANGER**

Hazard due to lack of effectiveness of the protective device

Persons and parts of the body to be protected may not be recognized in case of non-observance.

- ▶ Use of the safety laser scanner requires a risk assessment. Check whether additional protective measures are required.
 - ▶ Comply with the applicable national regulations derived from the application (e.g., work safety regulations, safety rules, or other relevant safety guidelines).
 - ▶ Apart from the procedures described in this document, the components of the safety laser scanner must not be opened.
 - ▶ The safety laser scanner must not be tampered with or changed.
 - ▶ Improper repair of the protective device can lead to a loss of the protective function. The protective device must only be repaired by the manufacturer or by someone authorized by the manufacturer.
-

4.2 Operator of the machine

**DANGER**

Hazard due to lack of effectiveness of the protective device

Persons and parts of the body to be protected may not be recognized in case of non-observance.

- ▶ Changes to the electrical integration of the safety laser scanner in the machine control and changes to the mechanical mounting of the safety laser scanner necessitate a new risk assessment. The results of this risk assessment may require the entity operating the machine to meet the obligations of a manufacturer.
 - ▶ Changes to the device's configuration may impair the protective function. The effectiveness of the protective device must be checked after any change to the configuration. The person carrying out the change is also responsible for maintaining the protective function of the device.
 - ▶ Apart from the procedures described in this document, the components of the safety laser scanner must not be opened.
 - ▶ The safety laser scanner must not be tampered with or changed.
 - ▶ Improper repair of the protective device can lead to a loss of the protective function. The protective device must only be repaired by the manufacturer or by someone authorized by the manufacturer.
-

4.3 Assembly

Important information



DANGER

Hazard due to lack of effectiveness of the protective device

Persons and parts of the body to be protected may not be recognized in case of non-observance.

The optical beam path must not be disrupted, e.g. if the system is incorporated into paneling.

- ▶ Do not apply an additional front screen.
- ▶ If a viewing slit is required, make sure that it is adequately dimensioned, [see "Dimensional drawings", page 157](#).



NOTE

Certain optical and electromagnetic ambient conditions can affect the safety laser scanner. This may have a negative impact on the availability of the machine. That is to say, the safety laser scanner switches off the machine even though there are no people in the protective field.

For high availability:

- ▶ Avoid having strong electric fields in the vicinity of the safety laser scanner. These may be caused by nearby welding or induction cables, for example.
- ▶ Avoid condensation on the optics cover.

Prerequisites

- The safety laser scanner must be affixed so that people or parts of the body are reliably detected upon entry into the hazardous area.
- The safety laser scanner must be affixed so that no mirrors or other exceedingly reflective objects are in the protective field.
- The safety laser scanner must be affixed so that no small objects (e.g. cables) are in the protective field, even if the safety outputs do not switch to the OFF state as a result.
- The safety laser scanner must be affixed so that no obstacles disrupt the field of view of the safety laser scanner. Take additional protective measures if a risk arises due to unavoidable obstacles.
- If people can stay between the protective device and the hazardous point without being detected, check if additional protective measures (e.g. restart interlock) are required.
- Reaching under, over and around, crawling beneath and stepping over the safety laser scanner, as well as moving it, must be prevented.

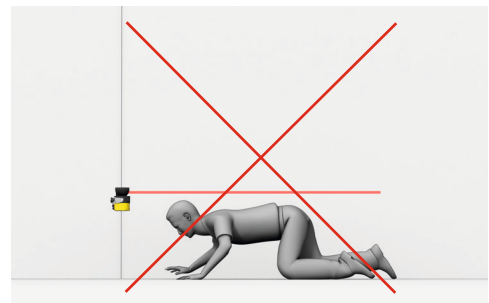
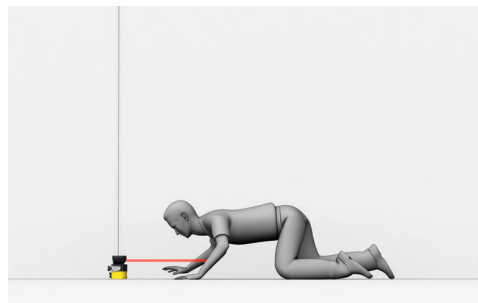

Figure 16: Prevent crawling beneath

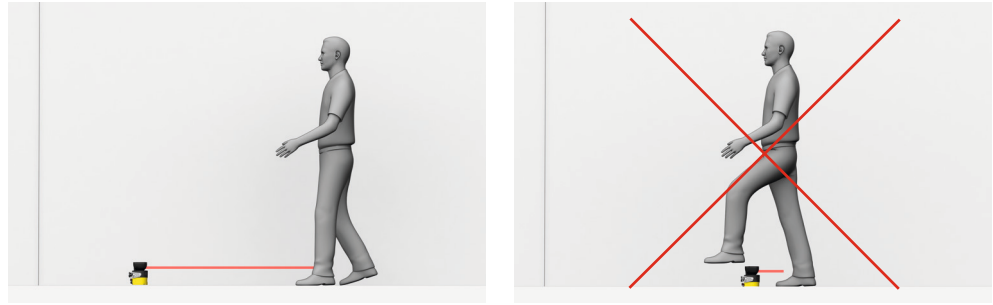

Figure 17: Prevent stepping over

Further topics

- ["Mounting", page 66](#)

4.3.1 Protection from influences

A safety laser scanner can be influenced by the beams from a different laser source in close proximity to it, e.g. by another laser scanner. This may impair the machine's availability. That is to say, the affected safety laser scanner switches the machine off, although no people are situated in the protective field.

A safety laser scanner may be dazzled by a strong external light source in the scan plane. This may have a negative impact on the availability of the machine. That is to say, the safety laser scanner switches off the machine even though there are no people in the protective field.

You can use the following measures to increase the availability:

- The safety laser scanner has a function for interference protection. The scan cycle time is adjusted in small increments. You can increase the availability by choosing different modes for interference protection in adjacent safety laser scanners, [see "Additional interference protection", page 89](#).
- Higher multiple sampling reduces the likelihood of a laser source influencing the safety laser scanner. You can increase the availability by setting multiple sampling to the highest value permitted in your application, while taking minimum distances into account, [see "Multiple sampling", page 87](#).
- You can further increase the availability by choosing a suitable mounting method, [see "Mounting methods for protection from interference from systems in close proximity", page 168](#).
- Avoid external light sources in the scan plane. Mount the safety laser scanner so that it cannot be dazzled by incoming sunlight. Do not position halogen lights, infrared light sources or stroboscopes directly on the scan plane.



NOTE

You must comply with the standard ISO 13855 when choosing the mounting method.

4.3.2 Preventing unprotected areas



DANGER

Hazard due to lack of effectiveness of the protective device

Persons and parts of the body to be protected may not be recognized in case of non-observance.

Mount the safety laser scanner so that people cannot enter unsecured areas. Take one or more of the measures described below as required:

- ▶ Attach deflector plates to prevent anyone standing behind.
- ▶ Mount the safety laser scanner in an undercut.
- ▶ Mount the safety laser scanner in the paneling of the machine or vehicle.
- ▶ Mount a frame to prevent access to the area.

Unsecured areas behind the safety laser scanner

Depending on the mounting situation, areas may result, which cannot be detected by the safety laser scanner.

The undetected areas become larger if the safety laser scanner is mounted using a mounting kit.

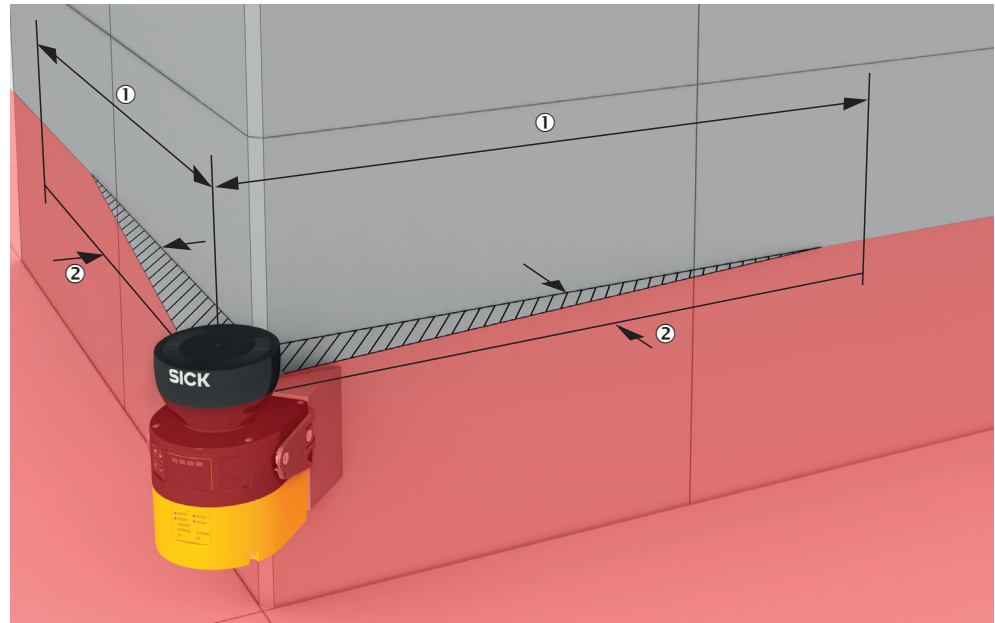

Figure 18: Unsecured areas

- ① Length of the unsecured area
- ② Width of the unsecured area

Area where detection capability is restricted

In close proximity (50 mm-wide area in front of the optics cover), the detection capability of the safety laser scanner may be restricted. If required, this area must be secured using an undercut or frame, for example.

Mounting with deflector plates

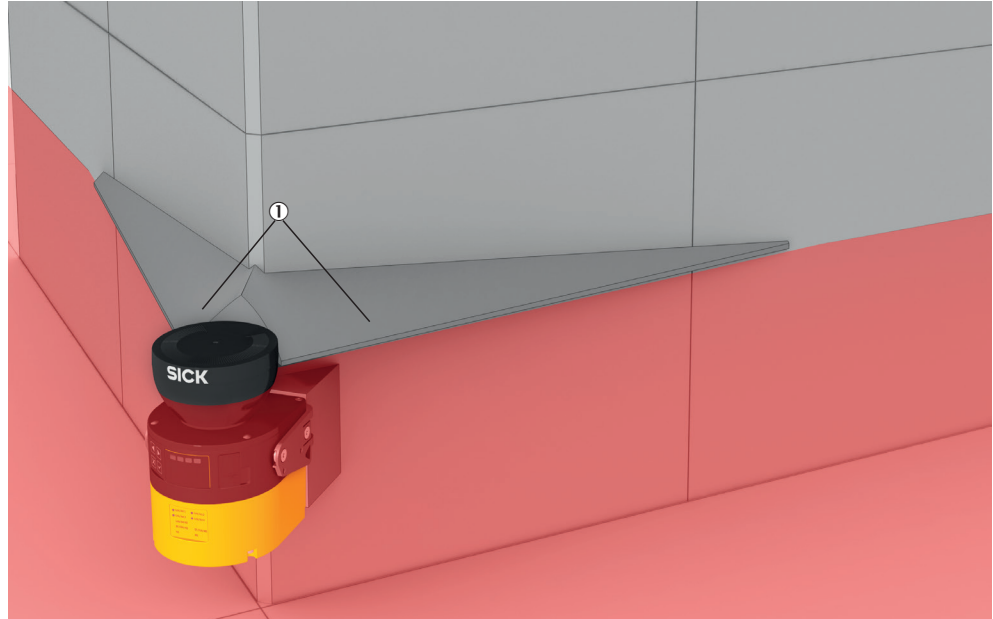

Figure 19: Mounting with deflector plates (example)

- ▶ Attach the deflector plates ① so that it is not possible to step into unsecured areas.
- ▶ Attach the deflector plates so that they lie outside the scan plane.

Mounting in an undercut

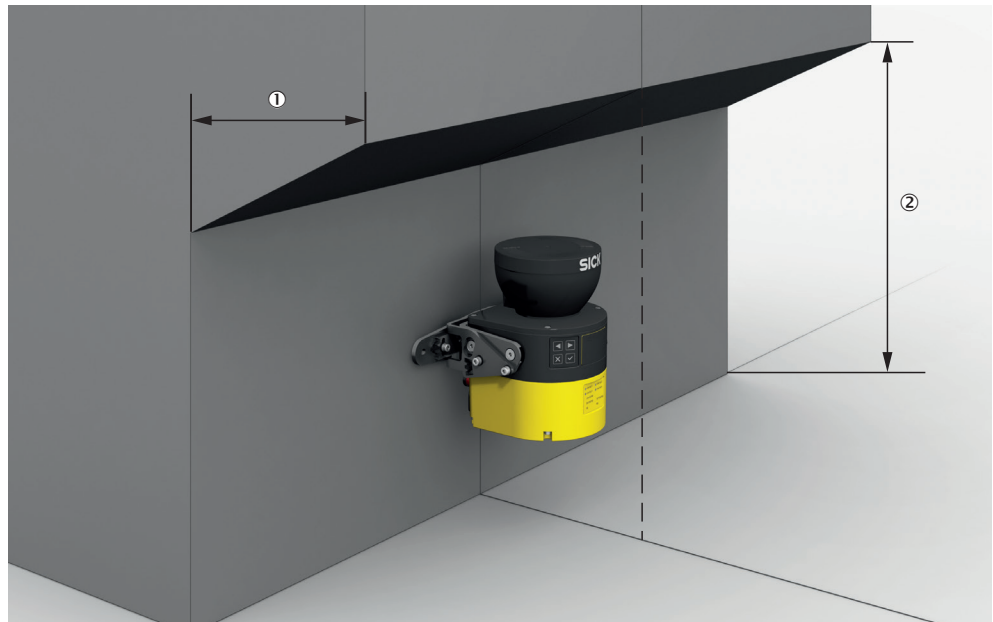

Figure 20: Mounting in an undercut (example)

- ▶ Mount the safety laser scanner in an undercut so that no-one can enter the unsecured areas.
- ▶ Make the undercut at least deep enough ①, that it covers the unsecured areas completely and no one can enter the unsecured areas.
- ▶ Prevent crawling beneath the undercut. Design the undercut to be so low ②, that no one can crawl into it.

Mounting in the machine or vehicle's paneling

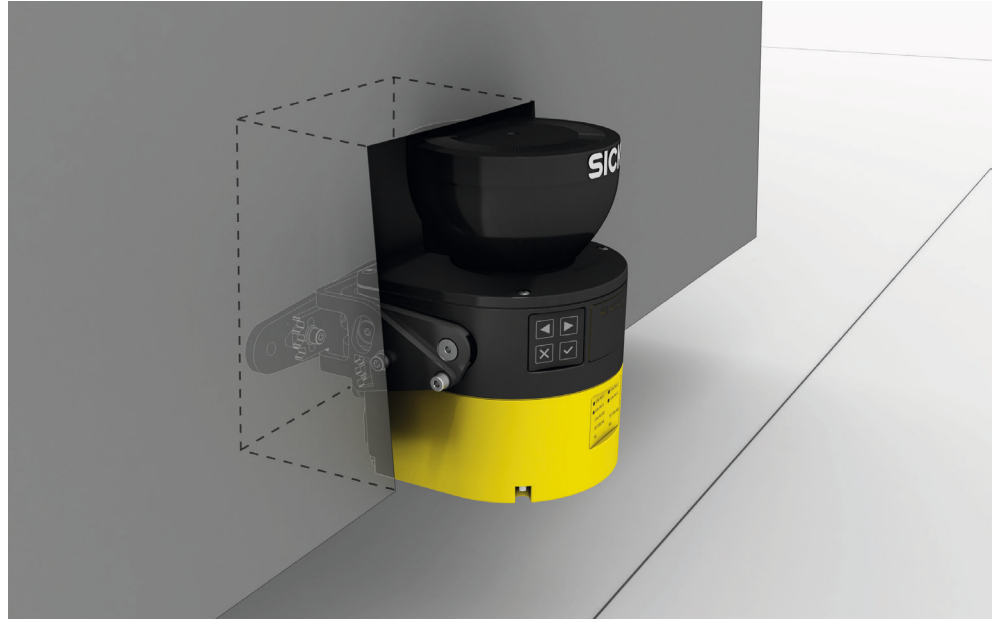

Figure 21: Mounting in vehicle paneling (example)

- ▶ If a viewing slit is required, make sure that its size is sufficient, see ["Dimensional drawings"](#), page 157.

4.3.3 Response time of the safety laser scanner

The safety laser scanner's response time must be taken into account, among other things, so that the safety laser scanner can be positioned in a suitable location and the protective fields can be sized correctly.

The response times are specified in the technical data, see ["Response times"](#), page 151.

The response time of the safety laser scanner resulting from current settings is shown in Safety Designer.

4.3.4 Reference contour monitoring

Vertical operation

National and international standards require or recommend that a reference contour is monitored if the angle between access direction and scan plane exceeds 30°. With the reference contour field, the safety laser scanner monitors the distance to a contour of the environment (e.g. a wall) in order to detect inadvertent adjustment or manipulation.

Configuring the reference contour field during vertical operation

- In many cases, it makes sense to use the floor and lateral vertical passage boundaries (e.g. door frames) as a reference contour.
- The resolution of the reference contour field specifies how large a gap in the contour or an object in the reference contour field must be for the reference contour field to detect the gap or object in any case. Smaller gaps or objects can also trigger detection in some cases.
- The length of the monitored contour must be greater than the set resolution of the reference contour field.
- The reference contour field has an adjustable tolerance band. If the safety laser scanner does not detect the reference contour within the tolerance band, all

safety outputs switch to the OFF state. In Safety Designer, you can define the tolerance band around the reference contour in both directions (near and far).

- For high availability, setting both the positive tolerance band (far) and the negative tolerance band (near) to the TZ value is recommended. (TZ = tolerance zone of the safety laser scanner, see "Data sheet", page 144.)
- The tolerance band must not be too wide. The reference contour field must detect a deviation from the reference contour before access to the hazardous point occurs next to the protective field. Deviations may occur due to changes in position or orientation.
- If the reference contour represents the edge of the protected opening, the sum of the negative and positive tolerance bands must not be greater than the resolution of the protective field.
- If the reference contour does not represent the edge of the protected opening, the sum of the negative and positive tolerance bands must not be greater than the projection.
- You can define a number of contours in the reference contour field and therefore monitor various areas in the environment.

Protective field and reference contour field for hazardous point protection

The protective field must be larger than the protected opening. The required overrun (o) is calculated using the following formula:

$$o \geq (2 \times TZ) - d$$

Where:

- o = overrun of the protective field over the opening
- TZ = tolerance zone of the safety laser scanner, see "Data sheet", page 144
- d = set resolution

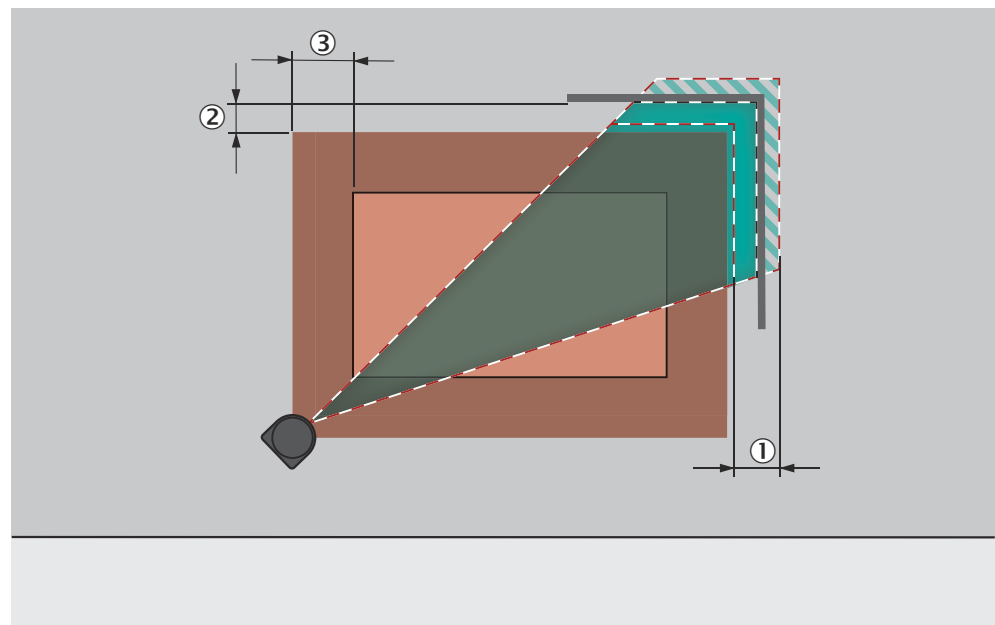

Figure 22: Overrun of the protective field in front of an opening

- ① Tolerance band of the reference contour field
- ② Distance of the protective field from the contour, to ensure availability
- ③ o = overrun of the protective field over the opening

Protective field and reference contour field for access protection

- If the reference contour represents the edge of the protected opening, its distance from the protective field must not exceed 100 mm. A distance equal to the TZ value is recommended for high availability and sufficient protection. (TZ = tolerance zone of the safety laser scanner, see "Data sheet", page 144.)
- If the reference contour does not represent the edge of the protected opening, the protective field must be larger than the protected opening. The required overrun (o) is calculated using the same formula as for hazardous point protection.

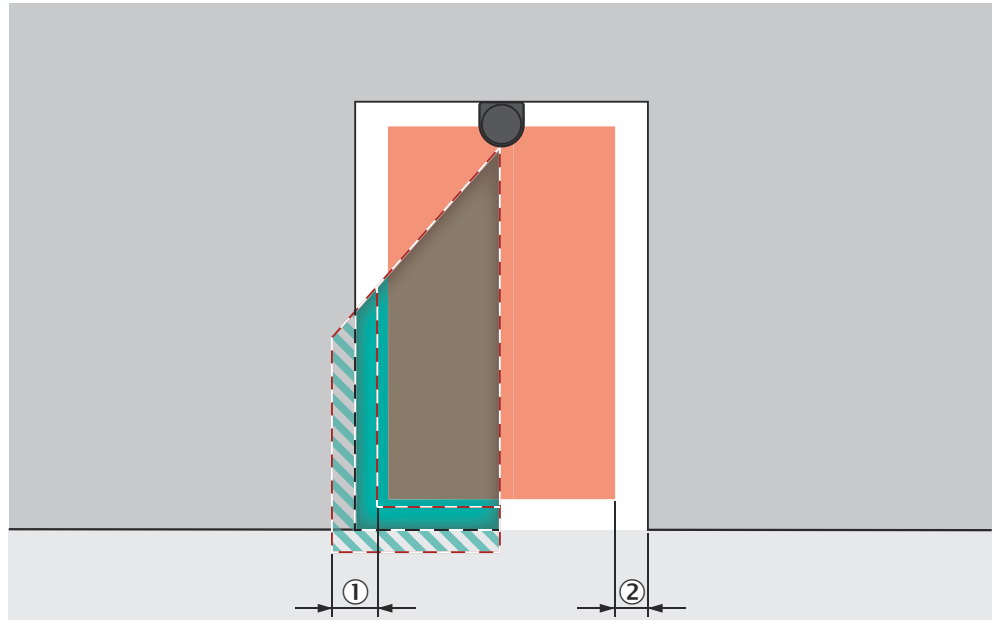

Figure 23: Tolerance band of the contour as reference field (protective field within the protected opening, edge of the protected opening = reference contour)

- ① Tolerance band of the reference contour field
- ② Distance of the protective field from the reference contour, to ensure availability

4.3.5 Monitoring case switching time

When switching between monitoring cases, it is possible that a person may already be in the newly activated protective field when switching takes place. Only switching in time (namely before the danger arises for the person at this location) ensures protection.



DANGER

Hazard due to lack of effectiveness of the protective device

- ▶ Switching of the monitoring case should be timed so that the safety laser scanner detects a person in the protective field with a sufficient minimum distance, before the dangerous state occurs.

**DANGER**

Hazard due to lack of effectiveness of the protective device

Persons or parts of the body to be protected may not be recognized or not recognized in time in case of non-observance.

In addition to the parameters considered below, the switching signal's propagation delay time up to the protective device also influences the switching duration. This includes the controls processing time, for example.

- ▶ Take account of the switching signal's propagation delay time up to the protective device.

In some cases, the process of switching between monitoring cases takes so long that the new monitoring case is not available inside the response time provided. This means that it may not be possible to detect a person in the protective field in time. In cases like this, you must start switching between monitoring cases earlier.

The following parameters influence the duration of the process:

- The set switch-on delay (see "Input delay", page 107).
- The processing time for the chosen input.

You calculate when to switch between monitoring cases as follows

1. First calculate how long it takes to switch between monitoring cases:

$$t_{CSR} = t_{ID} + t_i$$

where:

- t_{CSR} = time required for switching between monitoring cases in milliseconds (ms)
- t_{ID} = input delay for the control inputs in milliseconds (ms)
- t_i = processing time for the selected switching type in milliseconds (ms)
 - Local control input: $t_i = 12$ ms

2. Then calculate how much time is available in the response time for switching between monitoring cases:

$$t_{CSA} = (n - n_{CS}) \times t_S$$

where:

- t_{CSA} = time available for switching between monitoring cases in milliseconds (ms)
- n = set multiple sampling (default: $n = 2$)
- n_{CS} = multiple sampling after switching between monitoring cases (with setting **Fast** (default): $n_{CS} = 1$, with setting **Reliable**: $n_{CS} = n - 1$, with setting **User-defined**: $n_{CS} \leq n - 1$)
- t_S = scan cycle time (poss. incl. supplement due to interference protection) in milliseconds (ms)

3. Then check whether there is enough time available for switching between monitoring cases:

- If $t_{CSA} \geq t_{CSR}$: earlier start is not necessary.
- If $t_{CSA} < t_{CSR}$: you must start switching between monitoring cases earlier. The time advance t_{CSP} required is: $t_{CSP} = t_{CSR} - t_{CSA}$

**NOTE**

In some cases, it is not possible to define when to switch (for example because processing times of the machine vary) or the time advance means that the monitoring of an area finishes too early. Follow one of the following recommendations in these cases:

- ▶ Allow the two protective fields to partially overlap.

4.3.6 Hazardous area protection

The safety laser scanner is mounted with a horizontal scan plane in a stationary application. This is, for example, on a machine where the hazardous area is not completely surrounded by a physical guard. During hazardous area protection, the safety laser scanner detects a person's legs. The protective field is parallel to the person's direction of approach.

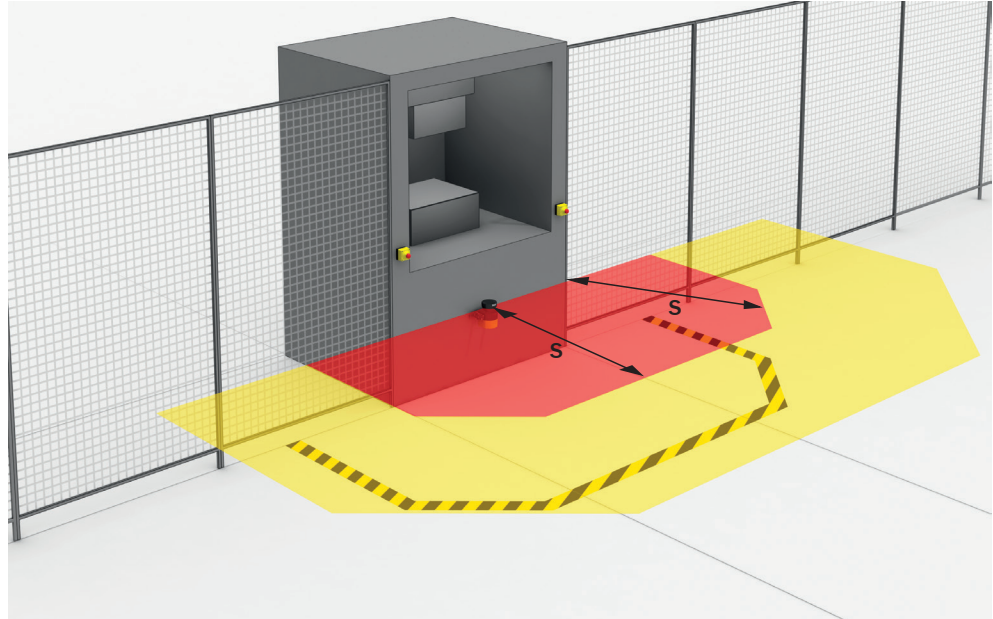

Figure 24: Stationary application with horizontal scan plane for hazardous area protection



NOTE

Mark the outline of the protective field boundaries on the floor after you have worked out the protective field size. By doing this, you allow machine operators to see the protective field boundaries and make it easier to thoroughly check the protective function at a later date.

4.3.6.1 Protective field

Overview

The protective field must be designed so that it detects a person at a minimum distance from the hazardous point. This distance is required to prevent a person or part of their body from reaching the hazardous area before the end of the machine's dangerous state.

In hazardous area protection, the minimum distance typically defines the protective field size required.

If you define a number of monitoring cases with different protective fields, you must calculate the protective field size separately for each protective field used.

In many cases, a resolution of 50 mm to 70 mm is suitable for hazardous area protection.

Important information



DANGER

Hazard due to lack of effectiveness of the protective device

In the case of non-compliance, it is possible that the dangerous state of the machine may not be stopped or not stopped in a timely manner.

1. Calculate the required minimum distance for your machine using the following formulas and examples.
 2. Take this calculation and the specifications in these instructions into account when mounting the safety laser scanner.
 3. Take this calculation and the specifications in these instructions into account when configuring the safety laser scanner.
-



DANGER

Hazard due to lack of effectiveness of the protective device

Persons and parts of the body to be protected may not be recognized in case of non-observance.

Body parts to be protected may not be detected under coarse resolution.

- ▶ Use a resolution of 70 mm or finer for hazardous area protection.
 - ▶ For hazardous area protection with a resolution of 70 mm: make sure that it is possible to detect a human leg.
 - ▶ For hazardous area protection with a resolution of 70 mm: mount the safety laser scanner at a height of at least 300 mm (height of the scan plane).
 - ▶ If it is not possible to mount the safety laser scanner at a height of at least 300 mm, use a finer resolution, [see "Calculating required resolution", page 38](#).
-



NOTE

If the protective field needs to be as small as possible, you may have to calculate the minimum distance multiple times with different scan cycle times (iterative calculation) because of various dependencies.²⁾

Always take the actual response time into account when calculating the minimum distance, [see "Response times", page 151](#).

1. First calculate the minimum distance on the basis of the response time for a small scan cycle time.
 2. If the calculated minimum distance is larger than the resulting protective field range ([see "Protective field range", page 153](#)), recalculate the minimum distance on the basis of the response time for a large scan cycle time.
-

4.3.6.2 Calculating minimum distance

Overview

The calculation of the minimum distance is based on international or national standards and statutory requirements applicable at the place of installation of the machine.

If the minimum distance is calculated according to ISO 13855, then it depends on the following points:

- Machine stopping time (time interval between triggering the sensor function and the end of the machine's dangerous state)
- Response time of the protective device, [see "Response times", page 151](#)
- Reach or approach speed of the person
- Resolution (detection capability) of the safety laser scanner

²⁾ The required minimum distance depends on the response time, among other things, and therefore on the scan cycle time. The protective field range likewise depends on the scan cycle time: the protective field range is shorter for a faster scan cycle time.

- Type of approach: parallel
- Parameters specified based on the application
- Supplements for general and, possibly, reflection-based measurement errors
- Supplement to protect against reaching over
- Height of the scan plane
- Switching time between monitoring cases

Important information



NOTE

Additional information is available in the ISO 13855 standard and in the Guide for Safe Machinery.



NOTE

SICK offers a stopping/run-down time measurement service in many countries.

Calculation example of the minimum distance S according to ISO 13855

The example shows the calculation of the minimum distance for parallel approach to the protective field. Depending on the application and the ambient conditions a different calculation may be required. (e.g., a protective field or at an arbitrary angle to the direction of approach or an indirect approach)

- Calculate S using the following formula:

$$S = 1,600 \text{ mm/s} \times T + TZ + Z_R + C_{RO}$$

where:

- S = minimum distance in millimeters (mm)
- T = stopping/run-down time for the entire system in seconds (s)
(Response time of the safety laser scanner + machine stopping time, incl. response time of the machine control system and signal propagation time)
- TZ = tolerance zone of the safety laser scanner, see "Data sheet", page 144
- Z_R = supplement for reflection-based measurement errors in millimeters (mm)
- C_{RO} = supplement to protect against reaching over, in millimeters (mm)

The reach/approach speed is already included in the formula.

Supplement Z_R for reflection-based measurement errors

All devices: If there is a retroreflector in the vicinity of the protective device (distance of the retroreflector from protective field ≤ 6 m), you must take the supplement $Z_R = 350$ mm into account.

Devices with max. protective field range of 9 m for stationary applications: Strongly reflective surfaces (e.g. shiny metal, tile) with a distance from the protective field ≤ 6 m can behave similarly to a retroreflector if the laser beam hits the surface vertically. If the protective field is larger than 50% of the protective field range in the direction of the laser beam which is hitting the surface vertically, you must take supplement $Z_R = 350$ mm into account in this direction. ³⁾ Supplement Z_R must be upheld at least at a width of $3 \times d$ ($d =$ set object resolution) around the laser beam which hits the surface vertically.

Supplement C_{RO} to protect against reaching over

Under certain circumstances, a person can reach the hazardous area by reaching over, before the protective device stops the dangerous state. Supplement C_{RO} prevents this.

³⁾ The protective field range depends on the set scan cycle time and resolution.

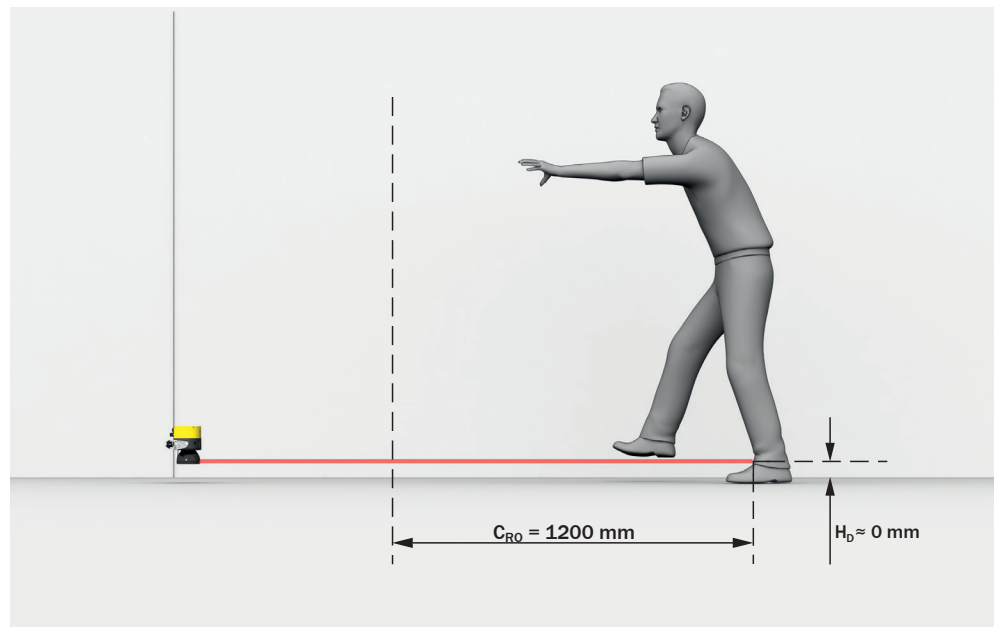

Figure 25: Protection against reaching over when mounted low (dimensions in mm)

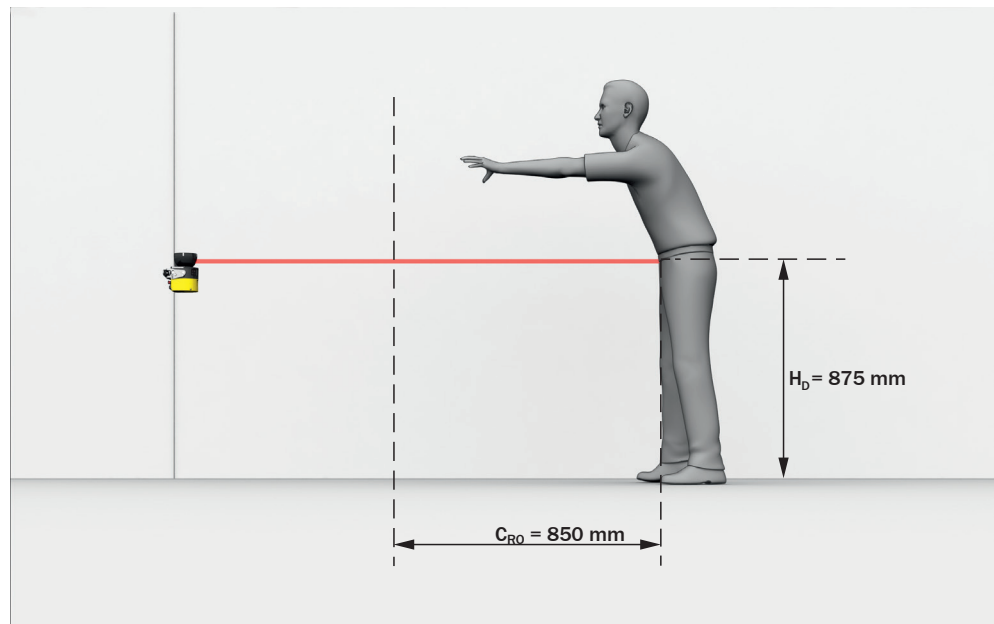

Figure 26: Protection against reaching over when mounted high (dimensions in mm)

The necessary supplement to the minimum distance depends on the height of the protective field's scan plane. The supplement is larger if the safety laser scanner is affixed low-down than if it is affixed high-up.

Calculating the supplement C_{RO}

- ▶ If you have sufficient free space in front of your machine, use value 1,200 mm as the supplement C_{RO} .
- ▶ If you want to keep the minimum distance as low as possible, use the following formula to calculate C_{RO} :

$$C_{RO} = 1,200 \text{ mm} - (0.4 \times H_D)$$

where:

- H_D = height of the protective field above the floor in millimeters (mm).

- ✓ If the result is $C_{RO} \geq 850$ mm, then use the calculated value as supplement C_{RO} .
- ✓ If the result is $C_{RO} < 850$ mm, then use $C_{RO} = 850$ mm (this value corresponds to an arm's length and is valid as a minimum supplement to protect against reaching over).

4.3.6.3 Height of the scan plane

Overview

If you choose a resolution of 70 mm for hazardous area protection, it is not possible to detect a human leg under certain circumstances. This is because a beam does not hit the leg. Rather, the beams pass by the sides of the ankle (see figure 27, page 37). If you mount the safety laser scanner at a height of at least 300 mm (height of the scan plane), the scan plane is at calf height and the leg is detected even at a resolution of 70 mm (see figure 28, page 38).

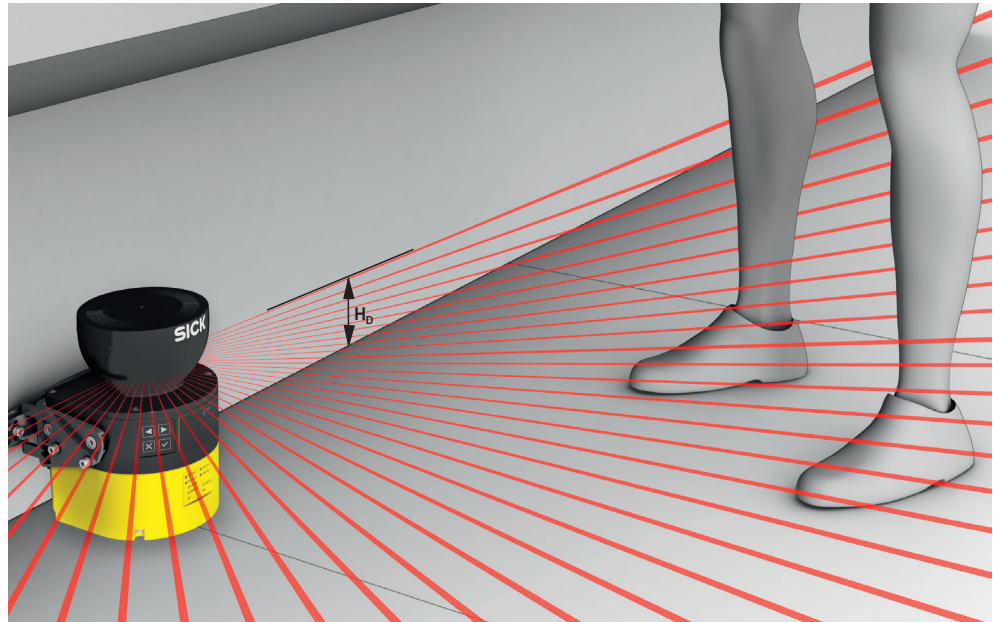

Figure 27: Scan plane at ankle height

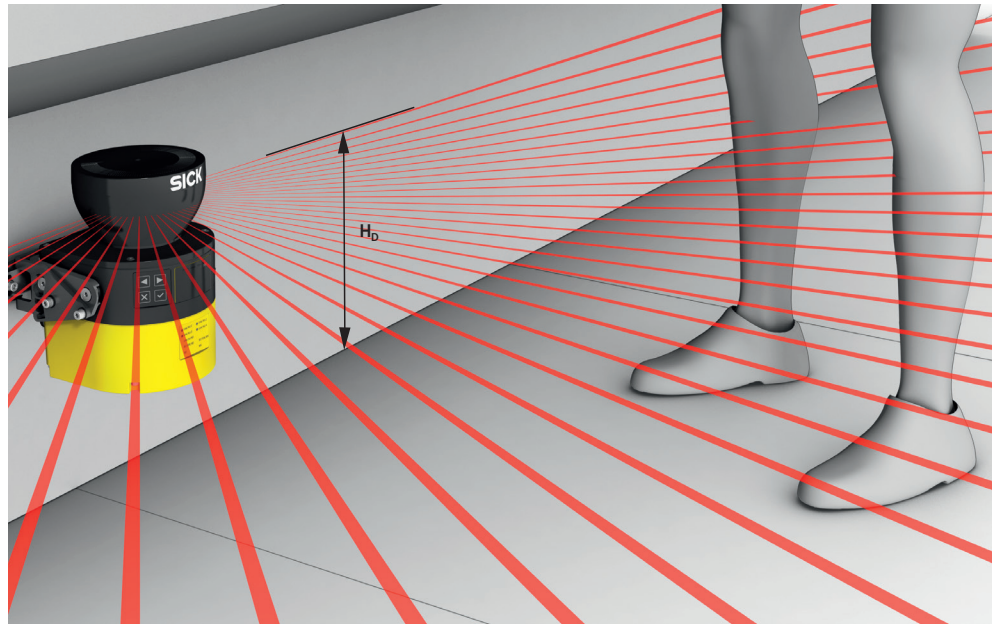

Figure 28: Scan plane at calf height

Important information



DANGER

Hazard due to lack of effectiveness of the protective device

It is possible to get around the protective device by crawling beneath.

- ▶ Prevent people from being able to crawl beneath the protective field by mounting the safety laser scanner appropriately.
- ▶ If you mount the protective device higher than 300 mm, you must use additional measures to prevent people crawling underneath.



DANGER

Hazard due to lack of effectiveness of the protective device

Persons and parts of the body to be protected may not be recognized in case of non-observance.

Body parts to be protected may not be detected under coarse resolution.

- ▶ Use a resolution of 70 mm or finer for hazardous area protection.
- ▶ For hazardous area protection with a resolution of 70 mm: make sure that it is possible to detect a human leg.
- ▶ For hazardous area protection with a resolution of 70 mm: mount the safety laser scanner at a height of at least 300 mm (height of the scan plane).
- ▶ If it is not possible to mount the safety laser scanner at a height of at least 300 mm, use a finer resolution, see "[Calculating required resolution](#)", page 38.

Calculating required resolution

If the height of the protective field (scan plane) is predefined and is less than 300 mm, you can calculate the required resolution using the following formula:

$$d_r = H_D / 15 + 50 \text{ mm}$$

where:

- d_r = coarsest permissible resolution of the safety laser scanner in millimeters (mm)
- H_D = height of the protective field above the floor in millimeters (mm)
- ▶ The safety laser scanner's resolution can be set to the predefined value d . If the result d_r does not match any of these values, choose a finer resolution ($d \leq d_r$).

4.3.6.4 Distance from walls

Overview

The availability may be impaired if the protective field stretches as far as a wall or a different object. So, plan to have a space between the protective field and the object. A distance of the TZ value is recommended to ensure availability. (TZ = tolerance zone of the safety laser scanner, see "Data sheet", page 144.)

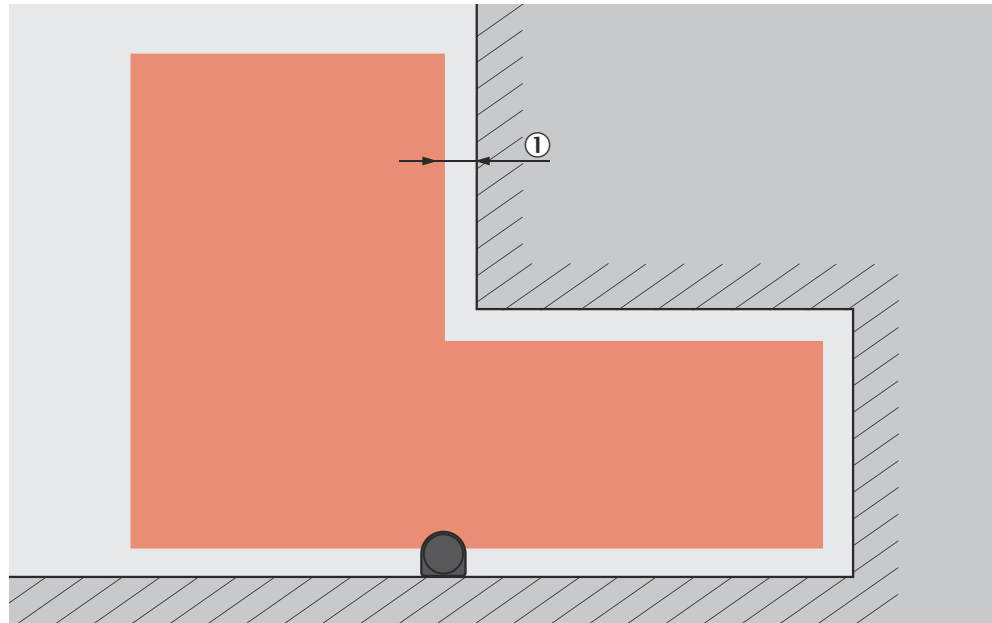

Figure 29: Distance of the protective field from the wall

- ① Recommended distance of the protective field from the wall.

Important information



DANGER

Hazard due to lack of effectiveness of the protective device

Persons and parts of the body to be protected may not be recognized in case of non-observance.

If the distance between the protective field and the wall is so large that a person can stand in it, this person might not be detected. If needed, take suitable measures to prevent this such as:

- ▶ Attaching deflector plates
- ▶ Attaching fence

4.3.7 Hazardous point protection

Overview

The safety laser scanner is mounted with a vertical scan plane in a stationary application. This is, for example, on a machine where the operator must stay close to the hazardous point. A fixed barrier with a height of at least 1,200 mm is located in front of the hazardous point. The operator can reach over the barrier and through the scan plane into the hazardous point. But the operator cannot climb over the barrier. If there is no such barrier available, access protection may be required.

During hazardous point protection, the safety laser scanner detects a person's hand or other part of their body. The protective field is orthogonal to the direction of approach of the body part. A resolution of 40 mm or finer is required to ensure detection of the hand during hazardous point protection.

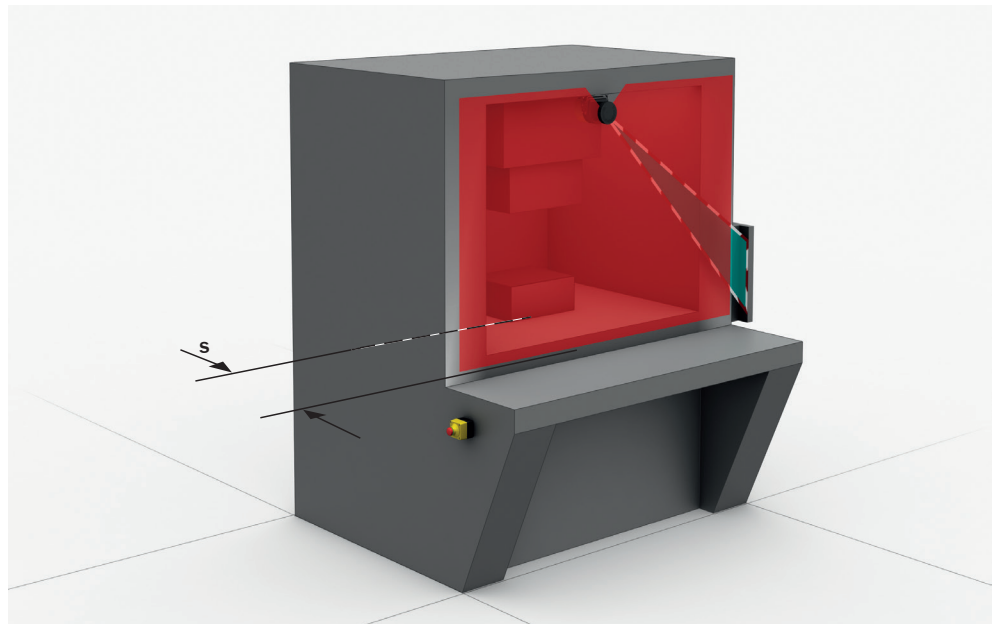

Figure 30: Stationary application in vertical operation for hazardous point protection

Important information



DANGER

Hazard due to lack of effectiveness of the protective device

Persons and parts of the body to be protected may not be recognized in case of non-observance.

The safety laser scanner is not suitable for finger detection, because the finest resolution is 30 mm.

- ▶ Never use the safety laser scanner for applications in which finger detection has to be realized.
- ▶ Use the contour of the environment as a reference to protect the protective device from inadvertent adjustment or tampering (see "[Reference contour monitoring](#)", page 29).

**DANGER**

Hazard due to lack of effectiveness of the protective device

If there is a retroreflector in the protective field level (distance of the retroreflector from protective field ≤ 6 m), it may not be possible to detect people and parts of the body that are to be protected, or it may not be possible to detect them on time.

- ▶ Avoid retroreflectors in the protective field level if possible.
- ▶ With retroreflectors at the protective field level: Increase overrun of the protective field over the opening to be protected by supplement $Z_R = 350$ mm.

**DANGER**

Hazard due to lack of effectiveness of the protective device

Devices with max. protective field range of 9 m: Strongly reflective surfaces (e.g. shiny metal, tile) with a distance from the protective field ≤ 6 m can behave similarly to a retroreflector if the laser beam hits the surface vertically. If the protective field is larger than 50% of the effective protective field range in the direction of the laser beam which is hitting the surface vertically, it is possible that persons and parts of the body that are to be protected will not be detected or not be detected on time.

- ▶ Avoid strongly reflective surfaces in the protective field level if possible.
- ▶ With strongly reflective surfaces in the protective field level: Increase overrun of the protective field over the opening to be protected by supplement $Z_R = 350$ mm.

Protective field

The protective field must be designed so that it detects access by a person at a minimum distance from the hazardous point. This distance is required to prevent a person or part of their body from reaching the hazardous area before the end of the machine's dangerous state.

In hazardous area protection, the minimum distance typically defines the position at which the safety laser scanner is mounted.

In many cases, a resolution of 30 mm or 40 mm is suitable for hazardous point protection.

**DANGER**

Hazard due to lack of effectiveness of the protective device

In the case of non-compliance, it is possible that the dangerous state of the machine may not be stopped or not stopped in a timely manner.

1. Calculate the required minimum distance for your machine using the following formulas and examples.
2. Take this calculation and the specifications in these instructions into account when mounting the safety laser scanner.
3. Take this calculation and the specifications in these instructions into account when configuring the safety laser scanner.

**DANGER**

Hazard due to lack of effectiveness of the protective device

Persons or parts of the body to be protected may not be recognized or not recognized in time in case of non-observance.

- ▶ Always mount the safety laser scanner so that it is impossible to reach around or behind.
- ▶ Provide suitable additional measures if necessary.

**NOTE**

The required minimum distance depends on the safety laser scanner's set resolution. Take account of the following notes when choosing the resolution:

- If you choose a fine resolution, the protective field range is smaller and the protective field is only suitable for smaller hazardous points. But the required minimum distance is smaller, you can mount the safety laser scanner closer to the hazardous point.
- If you choose a coarser resolution, the protective field range is larger and the protective field is also suitable for larger hazardous points. But the required minimum distance is larger, you must mount the safety laser scanner further away from the hazardous point.

Calculating minimum distance

The calculation of the minimum distance is based on international or national standards and statutory requirements applicable at the place of installation of the machine.

If the minimum distance is calculated according to ISO 13855, then it depends on the following points:

- Machine stopping time (time interval between triggering the sensor function and the end of the machine's dangerous state)
- Response time of the protective device, see "Response times", page 151
- Reach or approach speed of the person
- Resolution (detection capability) of the safety laser scanner
- Type of approach: orthogonal
- Parameters specified based on the application

**NOTE**

Additional information is available in the ISO 13855 standard and in the Guidelines Safe Machinery.

**NOTE**

SICK offers a stopping/run-down time measurement service in many countries.

Calculation example of the minimum distance S according to ISO 13855

The example shows the calculation of the minimum distance for an orthogonal approach to the protective field. A different calculation may be required depending on the application and the ambient conditions (for example, for a protective field parallel to or at any angle to the direction of approach or an indirect approach).

- ▶ First, calculate S using the following formula:

$$S = 2000 \text{ mm/s} \times T + 8 \times (d - 14 \text{ mm})$$
 where:
 - S = minimum distance in millimeters (mm)
 - T = stopping/run-down time for the entire system in seconds (s)
(Response time of the safety laser scanner + machine stopping time, incl. response time of the machine control system and signal propagation time)
 - d = resolution of the safety laser scanner in millimeters (mm)
 The reach/approach speed is already included in the formula.
- ✓ If the result S is ≤ 100 mm, use S = 100 mm.
- ✓ If the result $100 \text{ mm} < S \leq 500$ mm, use the calculated value as the minimum distance.
- ▶ If the result is $S > 500$ mm, you may be able to reduce the minimum distance using the following calculation:

$$S = 1600 \text{ mm/s} \times T + 8 \times (d - 14 \text{ mm})$$

- ✓ If the new value is $S > 500$ mm, use the newly calculated value as the minimum distance.
- ✓ If the new value S is ≤ 500 mm, then use 500 mm as the minimum distance.

4.3.8 Access protection

Overview

In a stationary application, for example on a machine where the point of access to the hazardous area can be physically defined, the safety laser scanner is mounted with a vertical scan plane. For access protection, the safety laser scanner detects an intrusion by a whole body. The protective field is orthogonal to the person's direction of approach.

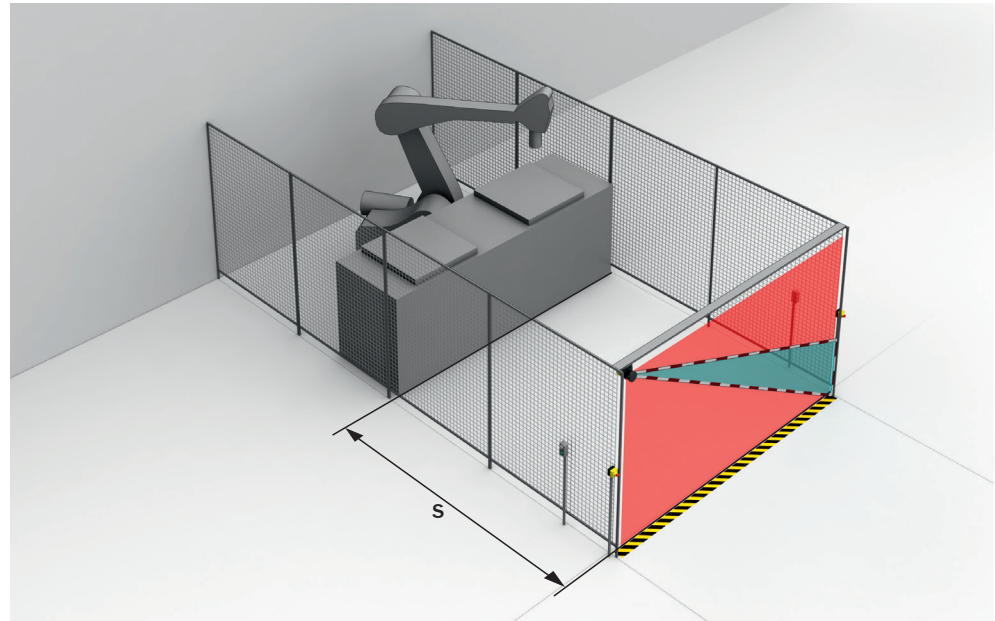

Figure 31: Stationary application in vertical operation for access protection

Important information



DANGER

Hazard due to lack of effectiveness of the protective device

Persons and parts of the body to be protected may not be recognized in case of non-observance.

- ▶ Use a resolution of 200 mm or finer. Otherwise, protection will not be ensured during access protection.
- ▶ Use double sampling during access protection. Under certain circumstances, a person could pass through the protective field without being detected when using higher multiple sampling.
- ▶ Use the contour of the environment as a reference to protect the protective device from inadvertent adjustment or tampering (see "[Reference contour monitoring](#)", page 29).



DANGER

Hazard due to lack of effectiveness of the protective device

If there is a retroreflector in the protective field level (distance of the retroreflector from protective field ≤ 6 m), it may not be possible to detect people and parts of the body that are to be protected, or it may not be possible to detect them on time.

- ▶ Avoid retroreflectors in the protective field level if possible.
 - ▶ With retroreflectors at the protective field level: Increase overrun of the protective field over the opening to be protected by supplement $Z_R = 350$ mm.
-



DANGER

Hazard due to lack of effectiveness of the protective device

Devices with max. protective field range of 9 m: Strongly reflective surfaces (e.g. shiny metal, tile) with a distance from the protective field ≤ 6 m can behave similarly to a retroreflector if the laser beam hits the surface vertically. If the protective field is larger than 50% of the effective protective field range in the direction of the laser beam which is hitting the surface vertically, it is possible that persons and parts of the body that are to be protected will not be detected or not be detected on time.

- ▶ Avoid strongly reflective surfaces in the protective field level if possible.
 - ▶ With strongly reflective surfaces in the protective field level: Increase overrun of the protective field over the opening to be protected by supplement $Z_R = 350$ mm.
-

4.3.8.1 Protective field

Overview

The protective field must be designed so that it detects a person at a minimum distance from the hazardous point. This distance is required to prevent a person or part of their body from reaching the hazardous area before the end of the machine's dangerous state.

In access protection, the minimum distance typically defines the position at which the safety laser scanner is mounted.

The protective field must cover a minimum area so that the safety laser scanner reliably detects a moving person:

- The lower edge of the protective field must not be more than 300 mm above the floor/ground according to ISO 13855.
- Resolution < 150 mm: The top edge of the protective field must be at least 900 mm above the floor/ground according to ISO 13855.
- Resolution 150 mm: The top edge of the protective field must be at least 1,100 mm above the floor/ground.
- Resolution 200 mm: The top edge of the protective field must be at least 1,400 mm above the floor/ground.
- Devices with a max. protective field range of 9 m: The top edge of the protective field must be at least 1,400 mm above the floor/ground.

Important information**DANGER**

Hazard due to lack of effectiveness of the protective device

In the case of non-compliance, it is possible that the dangerous state of the machine may not be stopped or not stopped in a timely manner.

1. Calculate the required minimum distance for your machine using the following formulas and examples.
2. Take this calculation and the specifications in these instructions into account when mounting the safety laser scanner.
3. Take this calculation and the specifications in these instructions into account when configuring the safety laser scanner.

4.3.8.2 Calculating minimum distance**Overview**

The calculation of the minimum distance is based on international or national standards and statutory requirements applicable at the place of installation of the machine.

If the minimum distance is calculated according to ISO 13855, then it depends on the following points:

- Machine stopping time (time interval between triggering the sensor function and the end of the machine's dangerous state)
- Response time of the protective device, [see "Response times", page 151](#)
- Reach or approach speed of the person
- Resolution (detection capability) of the safety laser scanner
- Type of approach: orthogonal
- Parameters specified based on the application
- Supplement to prevent reaching through

Important information**NOTE**

Additional information is available in the ISO 13855 standard and in the Guide for Safe Machinery.

**NOTE**

SICK offers a stopping/run-down time measurement service in many countries.

Calculation example of the minimum distance S according to ISO 13855

The example shows the calculation of the minimum distance for an orthogonal approach to the protective field. A different calculation may be required depending on the application and the ambient conditions (for example, for a protective field parallel to or at any angle to the direction of approach or an indirect approach).

- ▶ Calculate S using the following formula:

$$S = 1600 \text{ mm/s} \times T + 850 \text{ mm}$$
 where:
 - S = minimum distance in millimeters (mm)
 - T=stopping/run-down time for the entire system in seconds (s)
 (Response time of the safety laser scanner + machine stopping time, incl. response time of the machine control system and signal propagation time)
 The approach speed is already included in the formula.

4.3.9 Mobile hazardous area protection

The safety laser scanner is mounted with a horizontal scan plane in a mobile application, like on an automated guided vehicle. In mobile hazardous area protection, the safety laser scanner protects the hazardous area created by the vehicle's movement. The safety laser scanner detects a person's legs. The protective field is parallel to the direction of approach.

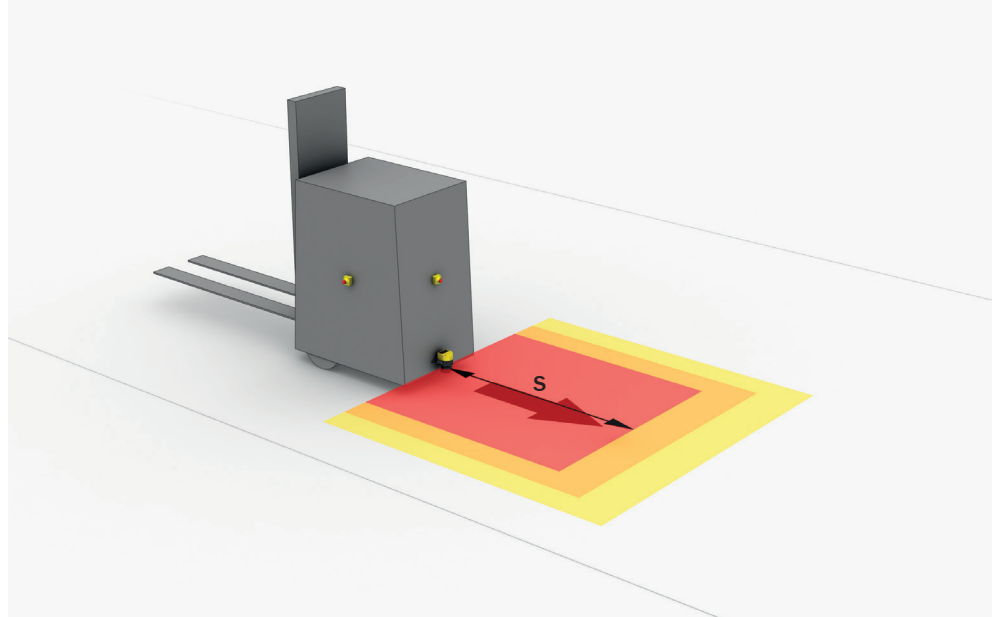

Figure 32: Mobile application in horizontal operation for hazardous area protection



DANGER

Hazard due to lack of effectiveness of the protective device

In the case of non-compliance, it is possible that the dangerous state of the machine may not be stopped or not stopped in a timely manner.

1. Calculate the minimum dimensions required for the protective field taking into account the supplements described in the following text along with the specific requirements imposed by your application.
2. Take this calculation and the specifications in these instructions into account when mounting the safety laser scanner.
3. Take this calculation and the specifications in these instructions into account when configuring the safety laser scanner.



NOTE

- In a mobile application, a resolution of 70 mm (leg detection) is sufficient for detecting people. By contrast with stationary hazardous point protection, this is also true for a low mounting height, as the safety laser scanner moves together with the vehicle.
- In the following calculation examples, only the vehicle speed is taken into account, not the speed of a walking person. This is based on the assumption that the person recognizes the danger and stands still.

4.3.9.1 Protective field length

The protective field must be designed so that it detects a person at a minimum distance from the hazardous point. This distance is required to ensure that the vehicle comes to a stop before it reaches a person or an object.

In mobile hazardous area protection, the minimum distance typically defines the protective field length required. When calculating the protective field length, the impact of turning must be considered separately.

If you define a number of monitoring cases with different protective fields, you must calculate the protective field size separately for each protective field used.

Supplement Z_R for reflection-based measurement errors

All devices: If there is a retroreflector in the vicinity of the protective device (distance of the retroreflector from protective field ≤ 6 m), you must take the supplement $Z_R = 350$ mm into account.

Supplement Z_F for lack of ground clearance

This supplement is necessary, because, generally, a person is detected above the foot and so the braking process cannot take account of the length of the foot in front of the point of detection. A person's foot could be injured if a vehicle has no ground clearance.

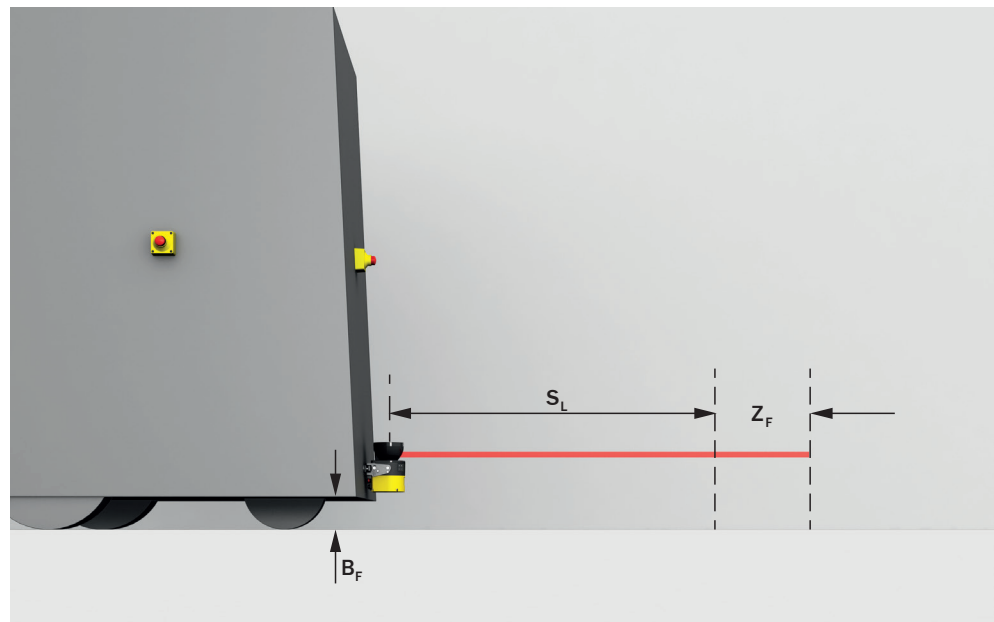

Figure 33: flat-rate supplement Z_F for lack of ground clearance

- B_F ground clearance
- S_L protective field length without a supplement for lack of ground clearance
- Z_F supplement for lack of ground clearance

The lump supplement for ground clearance under 120 mm is 150 mm. This supplement may be reduced further in individual cases. Read the supplement actually required for your vehicle's ground clearance from the following graph.

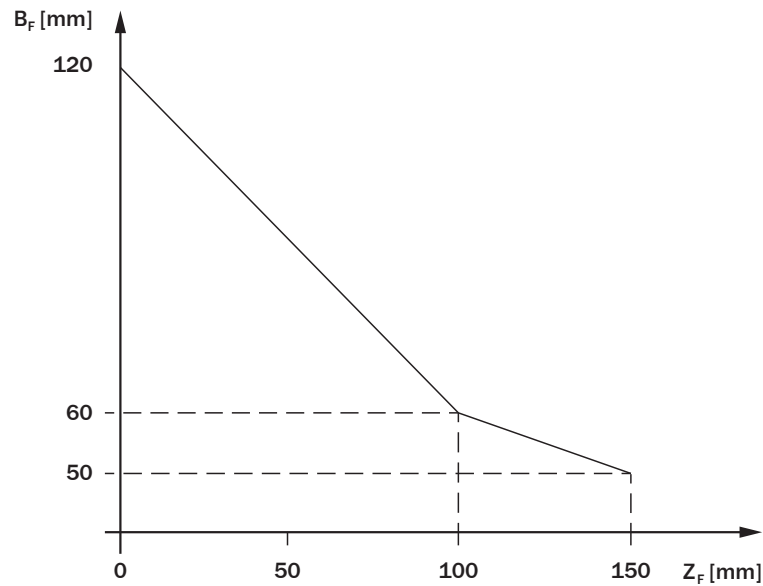

Figure 34: Minimum supplement for lack of ground clearance

B_F ground clearance in mm
 Z_F supplement for lack of ground clearance in mm

Calculation example for the protective field length S_L

$$S_L = S_A + TZ + Z_R + Z_F + Z_B$$

where:

- S_L = protective field length in millimeters (mm)
- S_A = stopping distance in millimeters (mm)
- TZ = tolerance zone of the safety laser scanner, see "Data sheet", page 144
- Z_R = supplement for reflection-based measurement errors in millimeters (mm)
- Z_F = supplement for lack of ground clearance of the vehicle in millimeters (mm)
- Z_B = supplement for the decreasing braking force of the vehicle, from the vehicle documentation, in millimeters (mm)

Stopping distance S_A

The stopping distance comprises the vehicle's braking distance and the distance covered during the safety laser scanner's response time and the vehicle control's response time (including signal propagation time).



NOTE

A vehicle's braking distance does not increase linearly with increasing speed, but rather in a squared relationship.

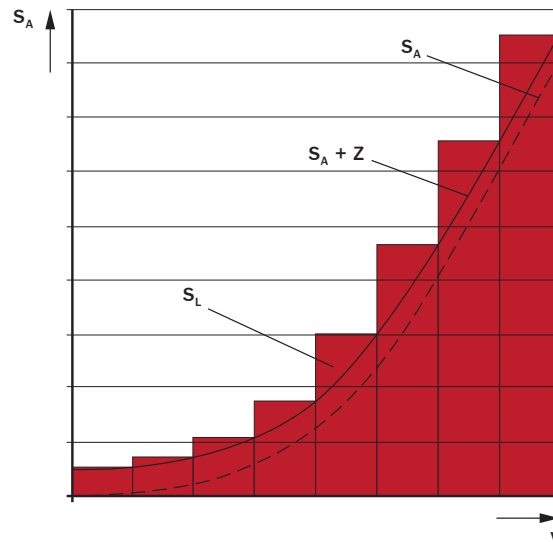

Figure 35: Stopping distance as a function of the vehicle's speed

- v speed
 S_A stopping distance
 Z supplements
 S_L protective field length for the relevant range of speeds

$$S_A = S_{Br} + S_{AnF} + S_{AnS}$$

where:

- S_A = stopping distance in millimeters (mm)
- S_{Br} = braking distance, from the vehicle documentation, in millimeters (mm)
- S_{AnF} = distance covered during the vehicle control's response time (including signal propagation time), from the vehicle documentation, in millimeters (mm)
- S_{AnS} = distance covered during the safety laser scanner's response time in millimeters (mm)

The distance S_{AnS} depends on the safety laser scanner's response time and the vehicle's speed. The distance S_{AnS} is calculated using the following formula:

$$S_{AnS} = t_R \times V_{max}$$

where:

- t_R = safety laser scanner's response time in seconds (s) (see "Response times", page 151)
- V_{max} = maximum speed of the vehicle, from the vehicle documentation, in millimeters per second (mm/s) (If you define a number of monitoring cases with different protective fields: V_{max} = maximum speed of the vehicle in the current monitoring case)

4.3.9.2 Protective field width

The protective field must be wide enough to cover the width of the loaded vehicle with supplements for measurement error and the lack of ground clearance. When calculating the protective field width, the impact of turning must be considered separately.

Supplement Z_R for reflection-based measurement errors

All devices: If there is a retroreflector in the vicinity of the protective device (distance of the retroreflector from protective field ≤ 6 m), you must take the supplement $Z_R = 350$ mm into account.

Supplement Z_F for lack of ground clearance

This supplement is necessary, because, generally, a person is detected above the foot and so the braking process cannot take account of the length of the foot in front of the point of detection. A person's foot could be injured if a vehicle has no ground clearance, see "[Supplement \$Z_F\$ for lack of ground clearance](#)", page 47.

Calculation example for the protective field width S_B

$$S_B = F_B + 2 \times (TZ + Z_R + Z_F)$$

where:

- S_B = protective field width in millimeters (mm)
- F_B = vehicle width in millimeters (mm)
- TZ = tolerance zone of the safety laser scanner, see "[Data sheet](#)", page 144
- Z_R = supplement for reflection-based measurement errors in millimeters (mm)
- Z_F = supplement for lack of ground clearance of the vehicle in millimeters (mm)



NOTE

In many cases, the safety laser scanner is mounted in the center of the vehicle. If this is not the case, you must define the protective field asymmetrically. Make sure that the supplements are located on the right and left of the vehicle.

4.3.9.3 Height of the scan plane



DANGER

Hazard due to lack of effectiveness of the protective device

Persons and parts of the body to be protected may not be recognized in case of non-observance.

- ▶ Mount the safety laser scanner so that the maximum scan plane height is 200 mm.
-

People who are lying down are reliably detected if the scan plane is at a height of no more than 200 mm.

In many cases, a mounting height of 150 mm above the floor (height of the scan plane) is suitable.

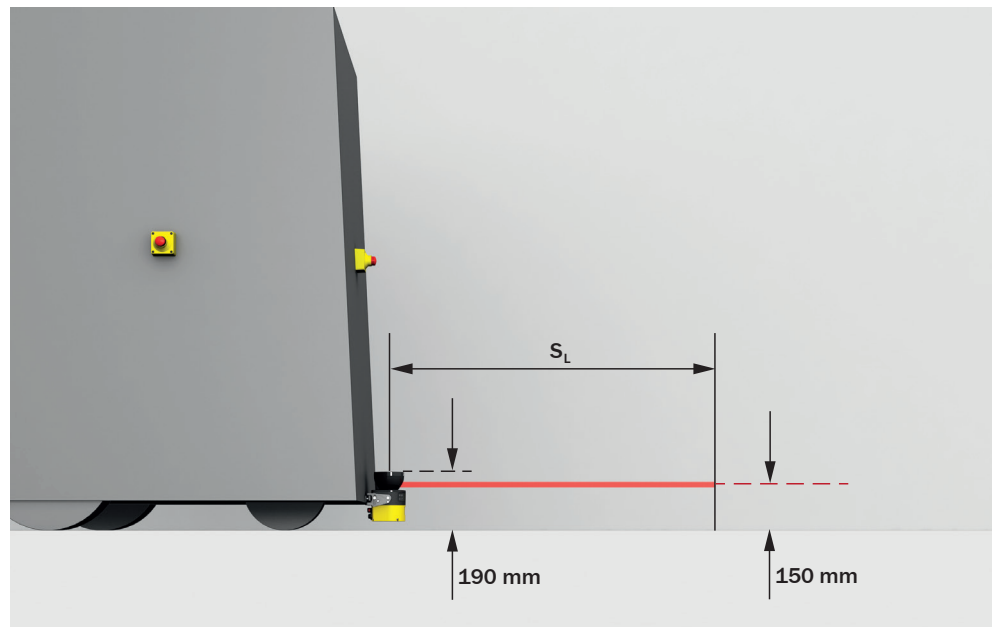

Figure 36: Recommended fitting height

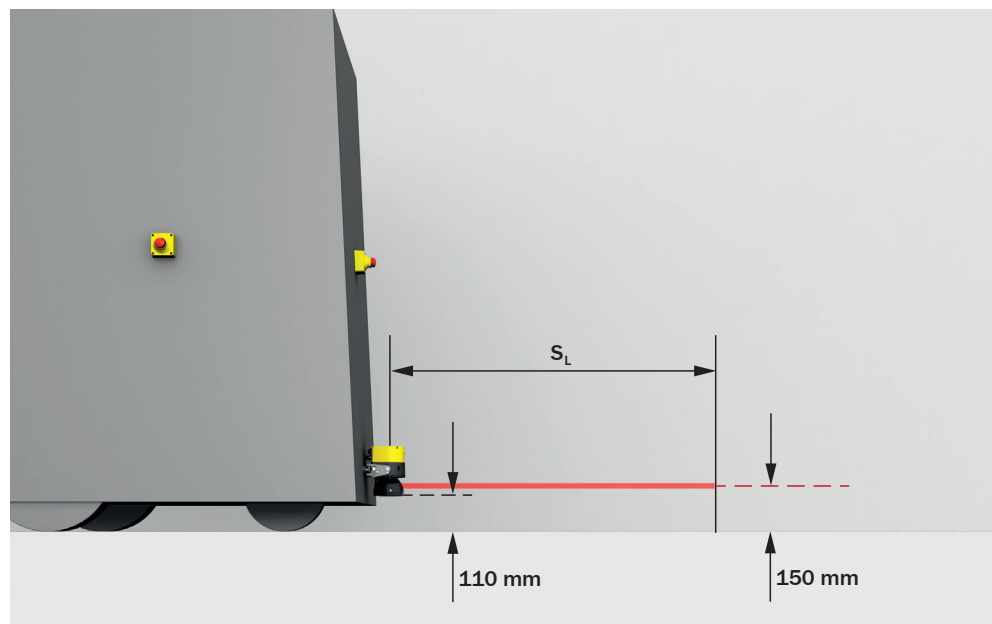

Figure 37: Recommended fitting height for inverted mounting

4.4 Integration in the electrical control system

This chapter contains important information about integration in the electrical control. Information about the individual steps for electrical installation of the device: [see "Electrical installation", page 69](#).

Information about pin assignment: [see "Pin assignment", page 71](#).

Requirements for use

The output signals of the protective device must be analyzed by downstream controllers in such a way that the dangerous state of the machine is ended safely. Depending on the safety concept, the signal is analyzed by safety relays or a safety controller, for example.



DANGER

Hazard due to lack of effectiveness of the protective device

In the case of non-compliance, it is possible that the dangerous state of the machine may not be stopped or not stopped in a timely manner.

- ▶ Make sure that the following control and electrical requirements are met so the safety laser scanner can fulfill its protective function.
-
- It must be possible to electrically influence the control of the machine.
 - Use the same earthing method for all devices that are electrically connected to the safety laser scanner.
 - All earthing points must be connected with the same ground potential.
 - Voltage must be supplied in accordance with SELV/PELV (IEC 60204-1) for all devices that are electrically connected to the safety laser scanner.
 - All devices connected to a local input or output of the safety laser scanner must be in the same SELV/PELV circuit as the safety laser scanner.
 - The control that is connected and all devices responsible for safety must comply with the required performance level and the required category (for example according to ISO 13849-1).
 - When using a safety controller, different signal levels of both OSSDs in an OSSD pair must be detected depending on applicable national regulations or required reliability of the safety function. The maximum discrepancy time tolerated by the control must be selected according to the application.
 - A restart interlock must be implemented depending on applicable national regulations or required reliability of the safety function. Each OSSD pair in the safety laser scanner is equipped with a configurable internal restart interlock. For safety laser scanners which do not have OSSDs, if a restart interlock is required, it must be provided in the external controller.



DANGER

Hazard due to lack of effectiveness of the protective device

In the case of non-compliance, it is possible that the dangerous state of the machine may not be stopped or not stopped in a timely manner.

Downstream contactors must be positively guided and monitored depending on applicable national regulations or required reliability of the safety function.

- ▶ Make sure that downstream contactors are monitored (external device monitoring, EDM).
-
- Each OSSD pair in the safety laser scanner is equipped with a configurable internal EDM.

The safety laser scanner complies with the regulations for electromagnetic compatibility (EMC) for the industrial sector (Radio Safety Class A).

4.4.1 Electromagnetic compatibility

Overview

Safety components switch all safety outputs to the OFF state in the event of errors in order to rule out potentially dangerous situations. For example, faulty data transmission must lead to a shutdown for safety-related devices, even if it can be tolerated for non-safety-related devices.

To avoid electromagnetic interference as much as possible, a consistent earthing method is required for the entire system. In particular, the functional earth must be connected using suitable conductors. Cables susceptible to interference and sources of interference should be routed separately.

Electromagnetic interference depends on the environment in which the product is used. The product is tested and certified according to common standards. It is therefore reliable when used in industrial environments.

Shielded cables

For shielded cables, the shielding should be applied on both sides and over a large area. Deviations are only permitted in exceptional and justified cases. Especially when using motors or other inductive consumers, one-sided support of the shielding is not sufficient because it does not act against inductive interferers.

Functional earth

The functional earth must be connected. The connection must be made in accordance with the earthing method of the system.

Options for connecting the functional earth:

- Pin or thread on M12 plug connector
- M5 threaded holes on the rear or side of the housing

The functional earth must be connected with low inductance, i.e. with a sufficient wire cross-section and the shortest possible length of cable.

4.4.2 Voltage supply



DANGER

Hazard due to lack of effectiveness of the protective device

In the case of non-compliance, it is possible that the dangerous state of the machine may not be stopped or not stopped in a timely manner.

- ▶ Make sure that the following control and electrical requirements are met so the safety laser scanner can fulfill its protective function.
 - The power supply unit must be able to jumper a brief power failure of 20 ms as specified in IEC 60204-1.
 - The safety laser scanner requires a supply voltage of 24 V. For details about tolerances and further connected loads, [see "Data sheet", page 144.](#)
 - The power supply unit must provide safe isolation according to IEC 61140 (SELV/PELV as per IEC 60204-1).⁴⁾
 - Make sure that the safety laser scanner is provided with an appropriate electrical fuse protection. Electrical data for calculating what fuse is required, [see "Data sheet", page 144.](#)
 - Use the same earthing method for all devices that are electrically connected to the safety laser scanner.

4) The voltage supply according to SELV has proven to be more reliable in demanding environments.

- Voltage must be supplied in accordance with SELV/PELV (IEC 60204-1) for all devices that are electrically connected to the safety laser scanner.
- All devices connected to a local input or output of the safety laser scanner must be in the same SELV/PELV circuit as the safety laser scanner.

4.4.3 USB connection

The safety laser scanner has a USB connection for configuration and diagnostics. The USB connection complies with the USB 2.0 mini-B standard (female connector). The USB connection may only be used temporarily and only for configuration and diagnostics. More information: [see "Configuration", page 72](#) and [see "Troubleshooting", page 133](#).

4.4.4 OSSDs

Safety laser scanners with local outputs can be directly integrated into the machine controller.



DANGER

Hazard due to lack of effectiveness of the protective device

In the case of non-compliance, it is possible that the dangerous state of the machine may not be stopped or not stopped in a timely manner.

- Make sure that the following control and electrical requirements are met so the safety laser scanner can fulfill its protective function.

- A restart interlock must be implemented depending on applicable national regulations or required reliability of the safety function. Each OSSD pair in the safety laser scanner is equipped with an internal restart interlock.
- When using a safety controller, different signal levels of both OSSDs in an OSSD pair must be detected depending on applicable national regulations or required reliability of the safety function. The maximum discrepancy time tolerated by the control must be selected according to the application.
- The output signals from an OSSD pair must not be connected to each other.
- In the machine controller, both signals from an OSSD pair must be processed separately.

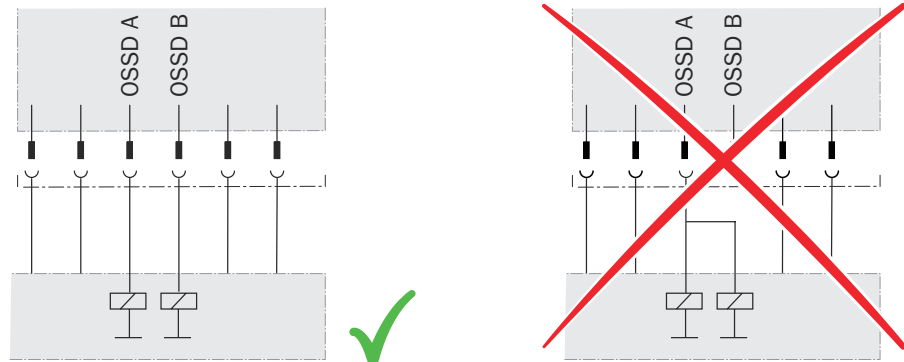

Figure 38: Dual-channel and separate connection of the OSSDs of an OSSD pair

- The machine must switch to the safe state if, at any time, at least one OSSD in an OSSD pair switches to the OFF state.

- Prevent the formation of a potential difference between the load and the protective device. If you connect loads to the OSSDs (safety outputs) that then also switch if controlled with negative voltage (e.g., electro-mechanical contactor without reverse polarity protection diode), you must connect the 0 V connections of these loads and those of the corresponding protective device individually and directly to the same 0 V terminal strip. In the event of an error, this is the only way to ensure that there can be no potential difference between the 0 V connections of the loads and those of the corresponding protective device.

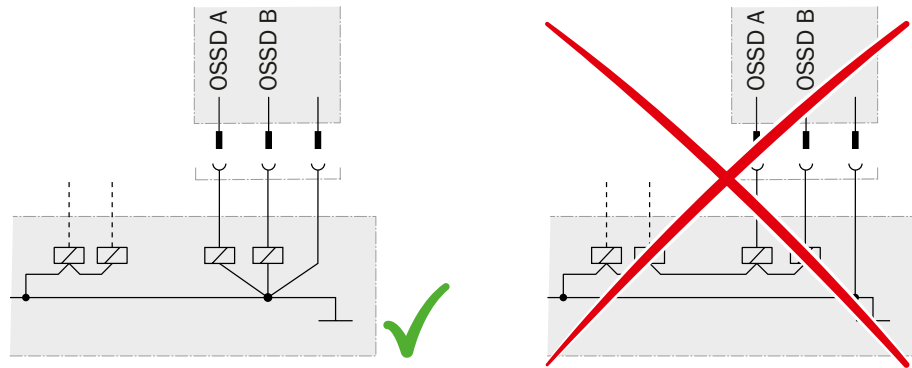

Figure 39: No potential difference between load and protective device



DANGER

Hazard due to lack of effectiveness of the protective device

In the case of non-compliance, it is possible that the dangerous state of the machine may not be stopped or not stopped in a timely manner.

Downstream contactors must be positively guided and monitored depending on applicable national regulations or required reliability of the safety function.

- Make sure that downstream contactors are monitored (external device monitoring, EDM).

- Each OSSD pair in the safety laser scanner is equipped with an internal EDM.

Requirements for the electrical control of the machine

The OSSDs are short-circuit protected to 24 V DC and 0 V. When the protective field is clear, the OSSDs signal the ON state with the HIGH signal level (non-isolated). If there are objects in the protective field or there is a device error, the OSSDs signal the OFF state with the LOW signal level.

4.4.5 Control inputs

Overview

The safety laser scanner is equipped with control inputs:

- The control inputs accept signals for switching between different monitoring cases.
- Static control inputs are used for information about machine status.

When switching between monitoring cases, bear in mind that a person may already be in the protective field when switching takes place. So, you must make sure that the monitoring case is switched at the right time. Only switching in time (namely before the danger arises for the person at this location) ensures protection, see "[Monitoring case switching time](#)", page 31.

Important information



DANGER

Hazard due to lack of effectiveness of the protective device

The dangerous state may not be stopped in the event of non-compliance.

The same safety level is required for the safety-related parts of the control which switch the active protective field as for the safety function. In many cases, this is PL d as per ISO 13849-1 or SIL2 as per IEC 62061.

- Use the same earthing method for all devices that are electrically connected to the safety laser scanner.
- Voltage must be supplied in accordance with SELV/PELV (IEC 60204-1) for all devices that are electrically connected to the safety laser scanner.
- All devices connected to a local input or output of the safety laser scanner must be in the same SELV/PELV circuit as the safety laser scanner.

Prerequisites

- Position-dependent switching is carried out by 2 independently wired signal sources, such as 2 independent position switches.
- Manual switching that depends on the operating mode is carried out using a suitable manual control switch.

Further topics

- ["Data sheet", page 144](#)
- ["Electrical installation", page 69](#)
- ["Inputs and outputs, local", page 102](#)

4.4.5.1 Static control inputs

Overview

The static control inputs support the following evaluation methods:

- Complementary analysis

You can define the switching criteria for the monitoring cases (see ["Monitoring cases", page 106](#)).

Complementary analysis

A static control input consists of 2 channels. To switch correctly, one channel must be switched inversely to the other. The following table shows which status the static control input's channels must have to define logical input condition 1 and 0 at the relevant control input.

Table 3: Status of the channels of the control inputs with complementary evaluation

A1	A2	Logical input status (input A)
1	0	0
0	1	1
1	1	Error
0	0	Error

In antivalent evaluation, the 2 channels of each static control input must always be inverted, even if the status of a control input in a monitoring case is random. If it is not inverted, all safety outputs switch to the OFF state and the device displays an error.

Complementary information

- When the input signal is changed, the previous monitoring case remains active for the duration of the set switch-on delay. If no valid input signal is present after the switch-on delay has elapsed, the behavior depends on the sequence monitoring:
 - If monitoring of the switching sequence (sequence monitoring) is not activated, the OSSDs switch to the OFF state after the switch-on delay has elapsed. If a valid input signal is present within another second, the safety laser scanner activates the new monitoring case. If no valid input signal is present within this time, the OSSDs remain in the OFF state and the safety laser scanner displays an error and must be restarted.
 - If monitoring of the switching sequence (sequence monitoring) is activated, the OSSDs switch to the OFF state after the switch-on delay has elapsed and the safety laser scanner displays an error and must be restarted.
- A short-circuit or cross-circuit on one or more channels of the static control inputs can cause the wrong monitoring case to be activated.
 - Some safety controllers detect the short-circuit or cross-circuit and switch off the outputs concerned or all their outputs.
 - Due to the short-circuit or cross-circuit, one or more input channels of the safety laser scanner can still deliver the HIGH signal level. This may result in a valid input signal so that a monitoring case is activated.
 - For this reason, laying the cables for the input signals in a protected manner is recommended. Otherwise, setting the switch-on delay to 0 s and activating sequence monitoring is recommended. Carrying out regular thorough checks at short intervals is also recommended.

Further topics

- ["Settings for monitoring case tables", page 106](#)

4.4.6 Universal inputs, universal outputs, universal I/Os

The safety laser scanner is equipped with universal I/Os.

Universal I/O can be configured as universal input or as universal output.

Depending on the device, a universal input can be used for resetting, external device monitoring (EDM), sleep mode, or restarting the protective device, for example. If sleep mode is activated by a universal input, the sleep mode must not be used for safety applications. Certain universal inputs can also be used in pairs as a static control input.

The function of a universal output is configurable. Which functions are available depends on the device. Possible signals are, for example: reset required, contamination warning.

A universal output must not be used for safety functions.

- ▶ Use the same earthing method for all devices that are electrically connected to the safety laser scanner.
- ▶ Voltage must be supplied in accordance with SELV/PELV (IEC 60204-1) for all devices that are electrically connected to the safety laser scanner.
- ▶ All devices connected to a local input or output of the safety laser scanner must be in the same SELV/PELV circuit as the safety laser scanner.

Information about electrical properties: [see "Technical data", page 143](#)

Information on pin assignment: [see "Electrical installation", page 69](#)

4.4.7 Restart interlock

Depending on the regulations which apply at the place of installation, a restart interlock may be required.

The restart interlock prevents the machine from automatically starting up, for example after a protective device has responded while the machine is operating or after changing the machine's operating mode.

First, the operator must press a reset pushbutton to return the protective device to monitoring status. Then, in a second step, the operator can restart the machine.

Depending on applicable national regulations, a restart interlock must be available if it is possible to stand behind the protective field.

Reset

The reset brings the protective device back to the monitoring state after it has sent a stop command. The reset also quits the start-up or restart interlock of a protective device, so that the machine can be restarted in a second step.

The reset must only be possible, when all safety functions and protective devices are functional.

The reset of the protective device must not introduce any movement or dangerous situations itself. The machine is only permitted to start after the reset once a separate start command has been sent.

- Manual resets are performed using a separate, manually operated device, such as a reset pushbutton.
- Automatic resets by the protective device are only permitted in special cases, if one of the following conditions is met:
 - It must not be possible for people to be in the hazardous area without triggering the protective device.
 - It must be ensured that no people are in the hazardous area during or after the reset.

Internal restart interlock

Each safety output of the safety laser scanner is equipped with a configurable internal restart interlock.

A reset pushbutton can be connected for each OSSD pair.

When the internal restart interlock is used, the following sequence is the result for the machine operator:

- 1 A safety output of the safety laser scanner switches to the OFF state, if there is an interruption in the protective field.
- 2 The safety output remains in the OFF state when there is no longer an object in the protective field.
- 3 The safety output only switches back to the ON state when the operator presses the reset pushbutton, which is outside the hazardous area. If there is an object in the protective field when the reset pushbutton is pressed, the safety output stays in the OFF state.
- 4 After the reset, the operator can restart the machine in a second step.

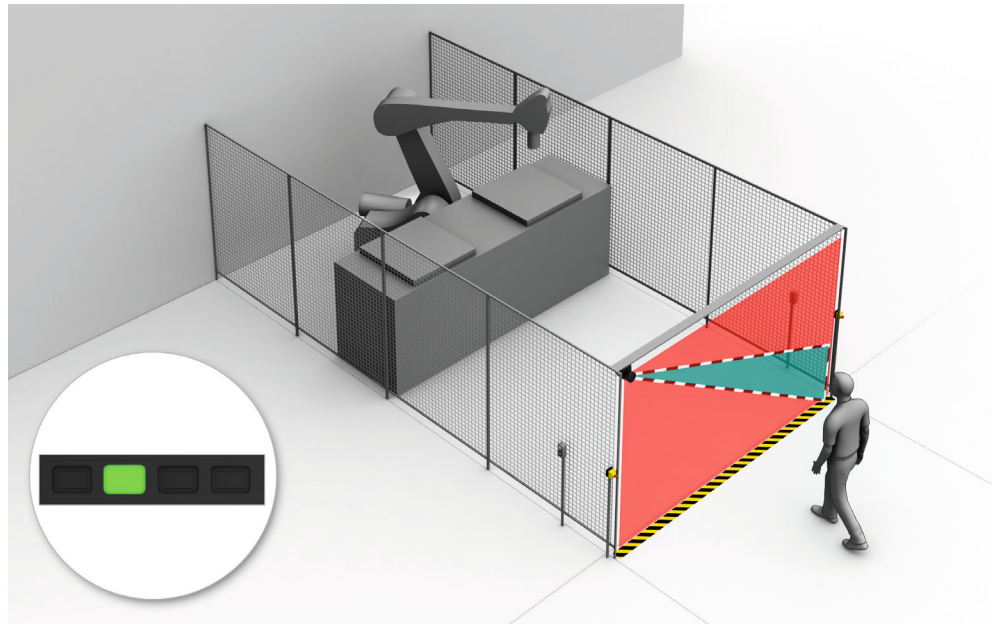

Figure 40: How the restart interlock works (1): no one in protective field, machine operates

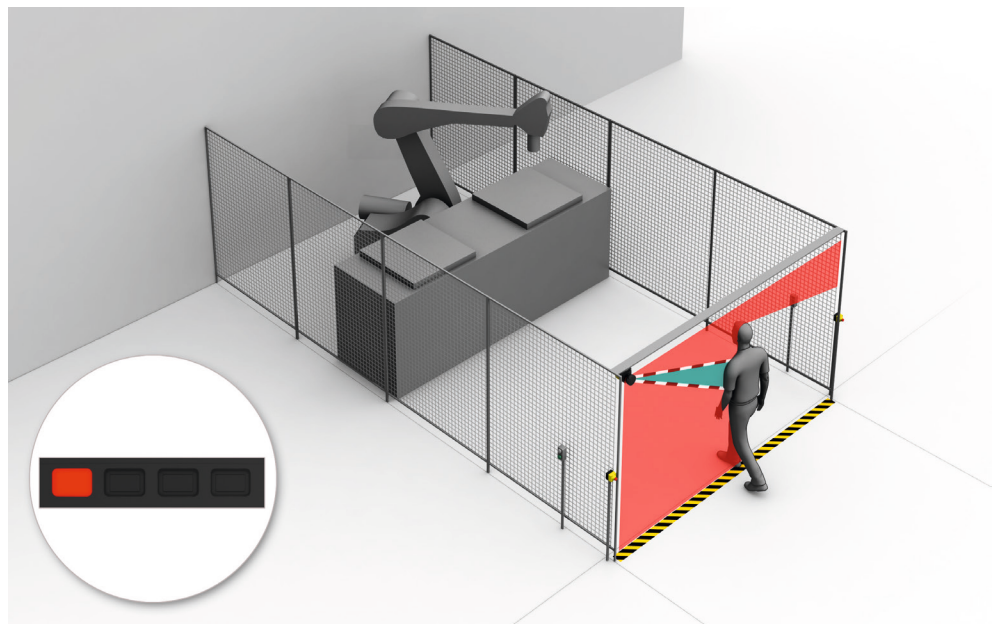

Figure 41: How the restart interlock works (2): person detected in protective field, safety output in OFF state

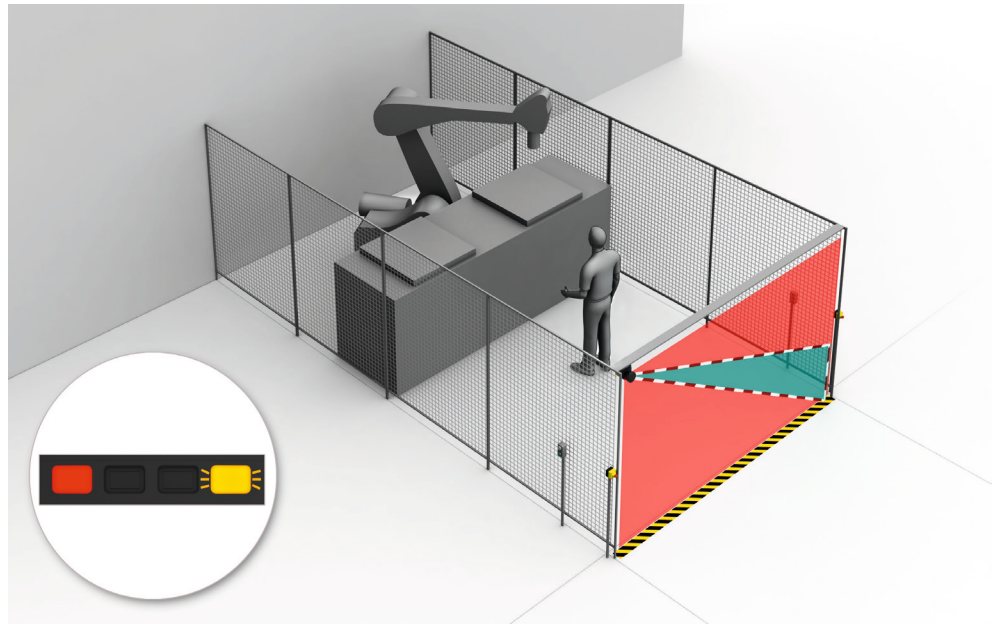

Figure 42: How the restart interlock works (3): person in hazardous area, no detection in protective field, safety output still in OFF state

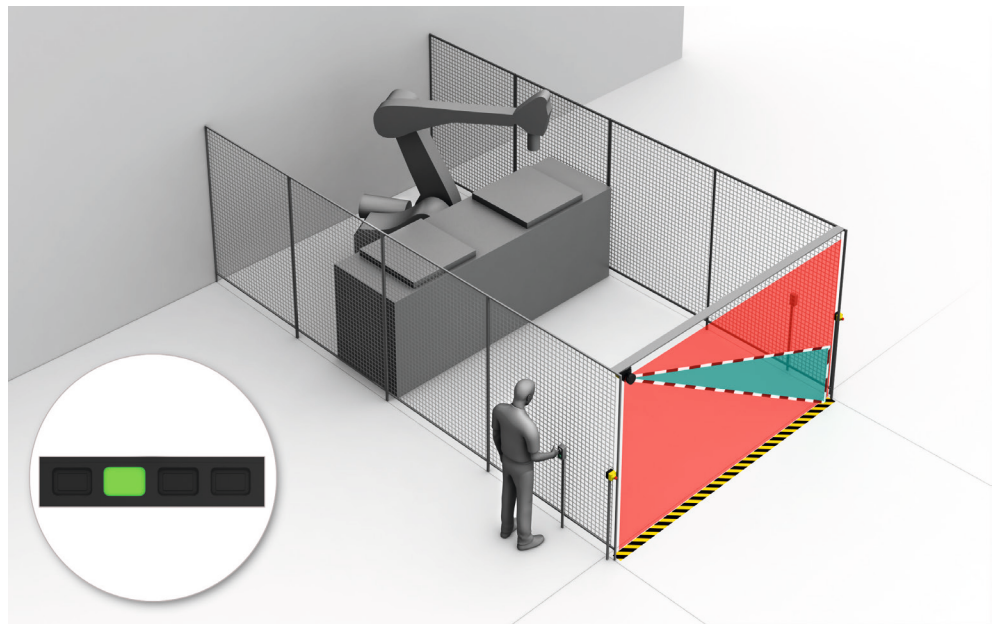

Figure 43: How the restart interlock works (4): the reset pushbutton must be pressed before restarting the machine.



DANGER

Hazard due to unexpected starting of the machine

- ▶ Affix the control switch for resetting the restart interlock outside the hazardous area.
- ▶ Make sure that the control switch cannot be activated by a person who is in the hazardous area.
- ▶ Also make sure that the person activating the control switch has a complete view of the hazardous area.

4.4.8 External device monitoring (EDM)

Overview

The external switching elements (external device monitoring, EDM) must be inspected in line with the regulations which apply at the place of installation or the required reliability of the safety function.

External device monitoring (EDM) monitors the status of downstream contactors.

Prerequisites

- Positively guided contactors are used for shutting down the machine.

Functionality

If you configure external device monitoring, then the safety laser scanner checks the contactors before each time an OSSD pair is switched on. External device monitoring is then able to detect if one of the contactor contacts is welded, for instance. In this case, the OSSDs remain in the OFF state.

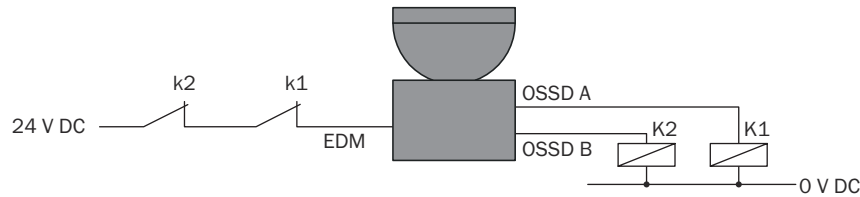

Figure 44: Electrical diagram of external device monitoring (EDM)

When the contactors (K1, K2) reach their rest position after the protective device has tripped, the two N/C contacts (k1, k2) close in a positively guided manner. 24 V is then present at the input of external device monitoring. If 24 V is not present before the OSSD pair is switched on, then one of the contactors is faulty and external device monitoring is preventing the OSSD pair from switching to the ON state.

In addition, external device monitoring checks the contactors after the OSSD pair is switched on. If both N/C contacts (k1, k2) remain closed after the OSSD pair is switched on, the OSSD pair switches back to the OFF state.

Complementary information

Each OSSD pair in the safety laser scanner is equipped with a configurable internal EDM.

4.4.9 Connection diagrams

You can find the connection diagrams at www.sick.com. To do so, enter the product part number in the search field (part number: see the entry in the “P/N” or “Ident. no.” field on the type label).

4.5 Testing plan

The protective device must be tested by appropriately qualified safety personnel when commissioning, after modifications and at regular intervals.

The manufacturer and user must define the type and frequency of the thorough checks of the machine on the basis of the application conditions and the risk assessment. Determination of the thorough checks must be documented in a traceable manner.

The following tests must be planned:

- Before commissioning the machine and after making changes, you must check whether the safety functions are fulfilling their planned purpose and whether persons are being adequately protected.
- The regular tests of the safety laser scanner must fulfill certain minimum requirements.

A test object is required for some thorough checks. An optically opaque cylinder with a black surface can be used as a suitable test object. The diameter must match the configured resolution.

4.5.1 Planning the thorough check during commissioning and in certain situations

Minimum requirements

The protective device and its application must be thoroughly checked in the following situations:

- Before commissioning
- After changes to the configuration or the safety function
- After changes to the mounting, the alignment or the electrical connection
- After exceptional events, such as after manipulation has been detected, after modification of the machine, or after replacing components

The thorough check ensures the following:

- Compliance with all relevant regulations and effectiveness of the protective device for all of the machine's operating modes. This includes the following points:
 - compliance with standards
 - correct use of the protective device
 - suitable configuration and safety function
 - correct alignment
- The documentation matches the state of the machine, incl. the protective device
- The verified configuration report corresponds to the desired project planning (see ["Verifying configuration", page 112](#))

The thorough checks must be carried out by qualified safety personnel or specially qualified and authorized personnel and must be documented in a traceable manner.

In many cases, other data must be documented, see ["Reports", page 113](#).

Recommended thorough checks

In many cases, it makes sense to carry out the following thorough checks during commissioning and in certain situations:

- Thorough check of the relevant points on the checklist, see ["Checklist for initial commissioning and commissioning", page 167](#)
- ["Thorough visual check of the machine and the protective device", page 65](#)
- ["Thorough check of the principal function of the protective device", page 63](#)
- ["Thorough check of the area to be protected", page 64](#)
- ["Test of the contour detection field", page 65](#)
- Make sure that the operating personnel has been instructed in the protective device's function before starting work on the machine. The instruction is the responsibility of the machine operator and must be carried out by qualified personnel.

4.5.2 Planning the regular thorough check

Overview

The purpose of regular tests is to detect defects due to changes or external influences (e.g. damage or manipulation) and to ensure that the protective measure provides the necessary protection.

Important information



DANGER

Hazard due to lack of effectiveness of the protective device

Persons and parts of the body to be protected may not be recognized in case of non-observance.

- ▶ Carry out tests at least once a year.
- ▶ Assign qualified safety personnel to carry out the tests or persons specifically authorized for this purpose.
- ▶ Document tests in a traceable manner.

Minimum requirements

The following thorough checks must be carried out at least once a year:

- ["Thorough check of the principal function of the protective device"](#), page 63
- Testing of the detection capability (resolution) in the context of the ["Thorough check of the area to be protected"](#), page 64

Recommendations for further thorough checks

In many cases, depending on the application conditions, the risk assessment of the machine determines that further thorough checks are required or that some thorough checks must take place more frequently.

In many cases, it makes sense to carry out the following thorough checks together with the regular thorough check:

- ["Thorough visual check of the machine and the protective device"](#), page 65
- ["Test of the contour detection field"](#), page 65
- Test of the relevant points on the checklist, see ["Checklist for initial commissioning and commissioning"](#), page 167

In many cases, it makes sense to carry out the following thorough checks daily:

- ["Thorough visual check of the machine and the protective device"](#), page 65
- ["Thorough check of the principal function of the protective device"](#), page 63

Complementary information

If a thorough check reveals an error, the machine should be shut down immediately. In this case, the mounting and electrical installation of the safety laser scanner must be checked by appropriately qualified safety personnel.

4.5.3 Notes on the tests

Thorough check of the principal function of the protective device

SICK recommends the following procedure:

- ▶ Watch the display and the status LEDs above the safety laser scanner's display. If, when the machine is switched on, at least one LED above the safety laser scanner's display does not light up permanently, you must assume that there is an error.
- ▶ Test the function of the protective device by triggering the protective function once and observing the safety output's reaction using the reaction of the machine, for example.
 - All applications: during the thorough check, observe whether the safety laser scanner displays the interruption of the protective field using the LEDs and/or the display.
 - Stationary application (hazardous area protection, access protection, hazardous point protection):

- Interrupt the protective field using the supplied test object and observe whether the machine stops.
- Mobile application (mobile hazardous area protection):
 - Place the supplied test object in the path of the vehicle and observe whether the vehicle stops.
- OR
- Activate a protective field, which is interrupted by at least one test object and check the expected reaction (for example by an automatic thorough check in the safety controller).

If the thorough check reveals an error, the machine should be shut down immediately. In this case, the mounting and electrical installation of the safety laser scanner must be checked by appropriately qualified safety personnel.

Thorough check of the area to be protected

The area to be protected and the detection capability are examined during this thorough check.

The thorough check covers the following points:

- Changes in the detection capability (thorough check of all configured fields)
- Modifications, tampering and damage to the protective device or the machine, which lead to changes in the area to be protected or the position of the protective field

SICK recommends the following procedure:

Hazardous area protection

- ▶ Position the supplied test object at a number of points at the edges of the area to be protected. The safety laser scanner must detect the test object at each position and indicate the detection. How it is indicated depends on the configuration. The number and position of sites where the thorough check is carried out must be chosen so that undetected access to the hazardous area is impossible.
- ▶ If a number of protective fields are used (in different monitoring cases for example), check the edges of all protective fields.

Access protection and hazardous point protection

- ▶ Move the supplied test object along the edges of the area to be protected. The safety laser scanner must detect the test object at each position and indicate the detection. How it is indicated depends on the configuration. The protective field must be dimensioned such that reaching around or going around it is impossible.
- ▶ If a number of protective fields are used (in different monitoring cases for example), check the edges of all protective fields.
- ▶ If the reference contour monitoring feature is used, check the areas with the reference contour:
 - Move the test object along the inner edge of the tolerance band of the reference contour. The safety laser scanner must detect the test object at each position and indicate the detection.
 - If a number of reference contours are used, check all reference contours.

Mobile hazardous area protection

- ▶ Place the supplied test object in the path of the vehicle and check whether the vehicle comes to a stop in time.
- ▶ If a number of protective fields are used (in different monitoring cases for example), check whether the vehicle comes to a stop in time in all of the protective fields.

- ▶ If necessary, change the position of the test object so that a thorough check is carried out for each monitoring case to determine whether the protective field is active over the whole of the required width.
- ▶ Check the height of the scan plane. The scan plane must be at a height of at least 200 mm so that people lying down can be reliably detected. For this purpose, position the supplied test object at a number of points at the edges of the area largest protective field. The safety laser scanner must detect the test object at each position and indicate the detection. How it is indicated depends on the configuration.

If the thorough check reveals an error, the machine should be shut down immediately. In this case, the mounting and electrical installation of the safety laser scanner must be checked by appropriately qualified safety personnel.

Test of the contour detection field

If you use contour detection fields, you must test whether each contour detection field fulfills the intended function.

Notes on planning the test

- Which contour should be detected at which position? What is the desired result?
- What is the desired result if the contour is not at the position?
- What is the desired result if only one part of the contour is at the position?
- Is it possible for there to be another object at the intended position instead of the expected object, so that the device still recognizes the contour? What is the desired result?

If the thorough check reveals an error, the machine should be shut down immediately. In this case, the mounting and electrical installation of the device must be checked by appropriately qualified safety personnel.

Thorough visual check of the machine and the protective device

SICK recommends the following procedure:

- ▶ Check whether the machine or the protective device has been modified or manipulated so that the effectiveness of the protective device may be impaired.
- ▶ Check the following points in particular.
 - Has the machine been retrofitted?
 - Have machine parts been removed?
 - Have modifications been made to the machine's surroundings?
 - Are there any defective cables or open cable ends?
 - Have the protective device or its parts been dismantled?
 - Is the protective device damaged?
 - Is the protective device severely contaminated?
 - Is the optics cover contaminated, scratched or destructed?
 - Has the protective device's alignment been changed?
 - Are there any objects (e.g. cables, reflective surfaces) in the protective field?

If one of the points applies, the machine should be shut down immediately. In this case, the machine and the protective device must be checked by appropriately qualified safety personnel.

5 Mounting

5.1 Safety

For information about the requirements for properly mounting the safety laser scanner, see ["Assembly", page 25](#).



DANGER

Death or severe injury due to electrical voltage and/or an unexpected startup of the machine

- ▶ Make sure that the machine is (and remains) disconnected from the voltage supply during mounting and electrical installation.
 - ▶ Make sure that the dangerous state of the machine is and remains switched off.
-



DANGER

Hazard due to lack of effectiveness of the protective device

If unsuitable brackets are used or if subjected to excessive vibrations, the device may become detached or damaged.

Persons or parts of the body to be protected may not be recognized or not recognized in time in case of non-observance.

- ▶ Only use SICK-approved brackets for mounting.
 - ▶ Take appropriate measures for vibration damping if vibration and shock specifications exceed the values and test conditions specified in the data sheet, see ["Data sheet", page 144](#).
-



DANGER

Improper work on the product

A modified product may not offer the expected protection if it is integrated incorrectly.

- ▶ Apart from the procedures described in this document, do not repair, open, manipulate or otherwise modify the product.
-



NOTICE

The optics cover of the safety laser scanner is an optical component.

- ▶ Do not contaminate or scratch the optics cover during unpacking and mounting.
 - ▶ Prevent fingerprints on the optics cover.
-



NOTE

Mount the device in the following order.

5.2 Unpacking

Procedure

- ▶ Check the components for completeness and the integrity of all parts.
- ▶ In the event of complaints, contact the responsible SICK subsidiary.

Further topics

- ["Ordering information", page 158](#)

5.3 Mounting procedure

The following options for mounting the safety laser scanner are available:

- mounting directly without a mounting kit
- mounting using mounting kit 1
- mounting using mounting kits 1 and 2

The mounting kits 1 and 2 are built upon one another. This means that for mounting using mounting kit 2, you also need mounting kit 1.

Each mounting kit consists of a bracket, and the screws needed to mount the safety laser scanner on the bracket.



DANGER

Hazard due to lack of effectiveness of the protective device

Persons or parts of the body to be protected may not be recognized or not recognized in time in case of non-observance.

- ▶ You must take account of the minimum distances calculated for your machine, [see "Assembly", page 25](#).
- ▶ Mount the safety laser scanner so that crawling beneath, climbing over and standing behind the protective fields is impossible.

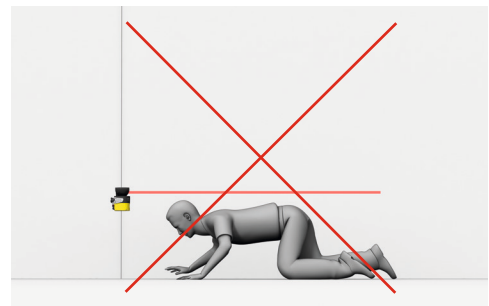
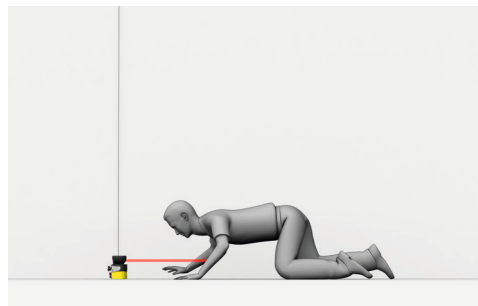

Figure 45: Prevent crawling beneath

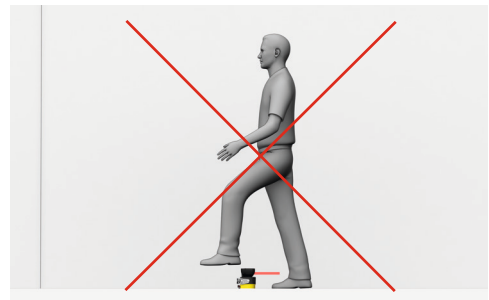
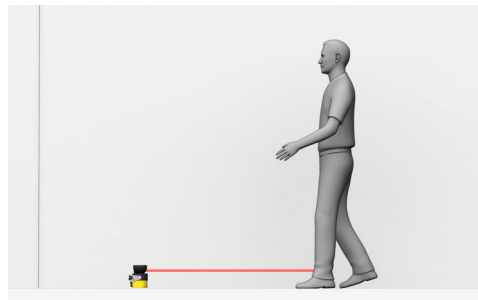

Figure 46: Prevent stepping over



NOTE

- ▶ Read this section completely before mounting the safety laser scanner.

Mounting instructions

- ▶ The optics cover of the safety laser scanner is an optical component. Make sure that the optics cover does not become dirty or scratched during unpacking and mounting. Prevent fingerprints on the optics cover.
- ▶ Mount the safety laser scanner so that it is protected from moisture, dirt and damage.

- ▶ Make sure that the safety laser scanner's field of view is not restricted.
- ▶ Make sure that there are not mirrors or other very reflective objects in the protective field.
- ▶ Make sure that no small objects (e.g. cables) are in the protective field, even if the safety outputs do not switch to the OFF state as a result.
- ▶ Mount the safety laser scanner so that the status indicators are clearly visible.
- ▶ Mount the safety laser scanner so that you can plug in and pull out the system plug.
- ▶ Take appropriate measures for vibration damping if vibration and shock specifications exceed the values and test conditions specified in the data sheet, see ["Data sheet", page 144](#).
- ▶ For machines that vibrate heavily, use thread-locking compounds to prevent the possibility of fixing screws coming loose unintentionally.
- ▶ Make sure that the safety laser scanner is aligned correctly, even during mounting: if the safety laser scanner is intended to monitor an area of 270° on a corner, the safety laser scanner may be mounted rotated by a maximum of 2.5° about the vertical axis.
- ▶ Location of the scan plane: see ["Dimensional drawings", page 157](#).
- ▶ Take account of the tightening torque for the fixing screws:
 - M5 at rear/at side = 4.5 Nm ... 5.0 Nm
 - M4 at rear/at side = 2.2 Nm ... 2.5 Nm
 Higher tightening torques may damage the thread. Lower tightening torques do not offer sufficient protection against slipping of the safety laser scanner due to vibrations, for example.

5.3.1 Direct mounting

The safety laser scanner has 4 M5 threaded holes on the back. If you are able to drill through the mounting surface from the rear, you can mount the safety laser scanner directly using these threaded holes.

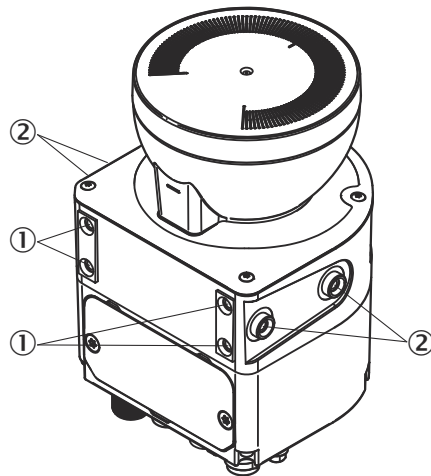

Figure 47: Mounting the safety laser scanner directly

- ① Rear M5 threaded hole
- ② Side M5 threaded hole

- ▶ Use either the rear or the side M5 threaded holes for direct mounting, see [figure 47, page 68](#).
- ▶ Use all four rear or all 4 side M5 threaded holes for direct mounting, so that the values given in the data sheet for vibration and shock resistance are achieved.
- ▶ Maximum depth of thread engagement: 7.5 mm (see ["Dimensional drawings", page 157](#)).
- ▶ Tightening torque: 4.5 Nm to 5.0 Nm.

6 Electrical installation

6.1 Safety

For information on the requirements that must be met for safe integration of the safety laser scanner into the controller and electronics of the machine: see "[Integration in the electrical control system](#)", page 51.

Mounting should be completed before electrical installation.

**DANGER**

Death or severe injury due to electrical voltage and/or an unexpected startup of the machine

- ▶ Make sure that the machine is (and remains) disconnected from the voltage supply during mounting and electrical installation.
- ▶ Make sure that the dangerous state of the machine is and remains switched off.

**DANGER**

Hazard due to lack of effectiveness of the protective device

In the case of non-compliance, it is possible that the dangerous state of the machine may not be stopped or not stopped in a timely manner.

- ▶ Make sure that the following control and electrical requirements are met so the safety laser scanner can fulfill its protective function.
-
- ▶ Use suitable power supply.
 - ▶ Use the same earthing method for all devices that are electrically connected to the safety laser scanner.
 - ▶ Check that all earthing points are connected with the same ground potential.
 - ▶ Voltage must be supplied in accordance with SELV/PELV (IEC 60204-1) for all devices that are electrically connected to the safety laser scanner.
 - ▶ All devices connected to a local input or output of the safety laser scanner must be in the same SELV/PELV circuit as the safety laser scanner.
 - ▶ Connect functional earth correctly.

**DANGER**

Hazard due to lack of effectiveness of the protective device

The dangerous state may not be stopped in the event of non-compliance.

- ▶ Always connect the two OSSDs in an OSSD pair separately from one another. The two OSSDs must not be connected to each other.
 - ▶ Connect the OSSDs such that the machine controller processes both signals separately.
-

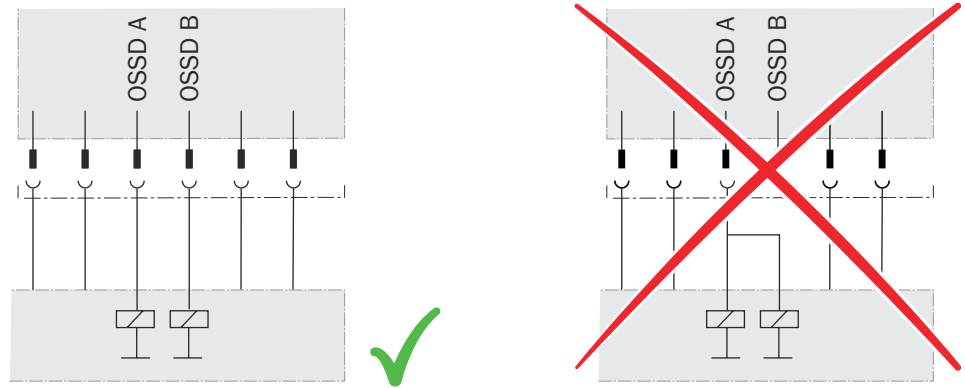

Figure 48: Connection of the OSSDs of an OSSD pair



DANGER

Hazard due to lack of effectiveness of the protective device

The dangerous state may not be stopped in the event of non-compliance.

- ▶ Prevent the formation of a potential difference between the load and the protective device.
- ▶ If you connect loads to the OSSDs (safety outputs) that then also switch if controlled with negative voltage (e.g., electro-mechanical contactor without reverse polarity protection diode), you must connect the 0 V connections of these loads and those of the corresponding protective device individually and directly to the same 0 V terminal strip. In the event of an error, this is the only way to ensure that there can be no potential difference between the 0 V connections of the loads and those of the corresponding protective device.

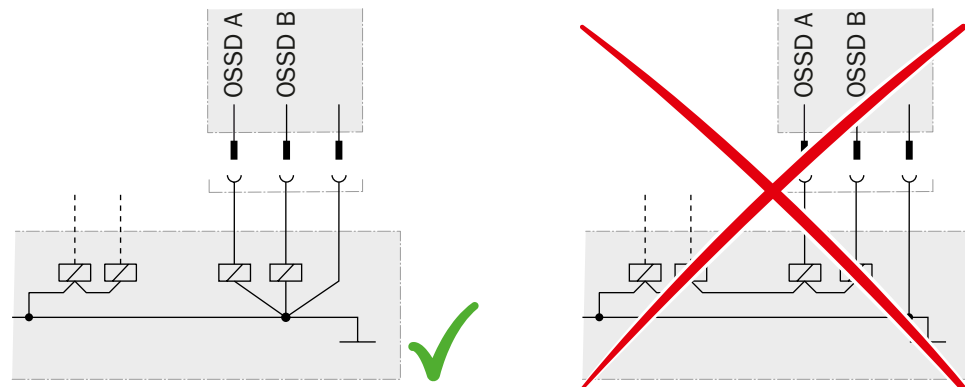

Figure 49: No potential difference between load and protective device

6.2 Connection overview



NOTE

The USB connection may only be used temporarily and only for configuration and diagnostics.

6.2.1 microScan3 Core

Table 4: System plug and connections: microScan3 Core

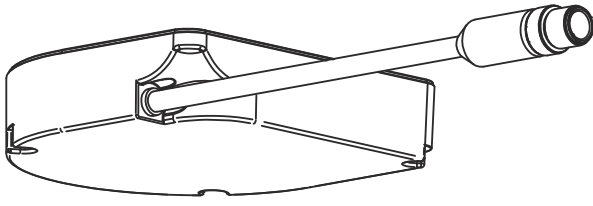
Safety laser scanner	Suitable system plug	Plug connector
microScan3 Core I/O	 <p>MICSX-ABIZZZZ1 (part number: 2073156)</p>	<ul style="list-style-type: none"> Connecting cable with M12 plug connector, see page 71

6.3 Pin assignment

You will find the pin assignment for the individual plug connectors in the following.

6.3.1 Connecting cable with M12 plug connector

Voltage is supplied and local inputs and outputs are connected via the connecting cable with an 8-pin, A-coded M12 male connector.

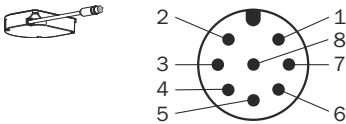

Figure 50: Pin assignment of the connecting cable (male connector, M12, 8-pin, A-coded)

Table 5: Pin assignment of the connecting cable with M12 plug connector

Pin	Marking	Function
1	+24 V DC	Supply voltage (+24 V DC)
2	OSSD 1.A	OSSD pair 1, OSSD A
3	0 V DC	Supply voltage (0 V DC)
4	OSSD 1.B	OSSD pair 1, OSSD B
5	Uni-I/O 01	Universal I/O 1, configurable: <ul style="list-style-type: none"> Universal input: resetting, EDM (external device monitoring), sleep mode, restarting the device Universal output: contamination, error, reset required, monitoring result (warning field)
6	Uni-I/O 02	Universal I/O 2, configurable: <ul style="list-style-type: none"> Control input A1 (together with pin 7) Universal input: resetting, EDM (external device monitoring), sleep mode, restarting the device Universal output: contamination, error, reset required, monitoring result (warning field)
7	Uni-I/O 03	Universal I/O 3, configurable: <ul style="list-style-type: none"> Control input A2 (together with pin 6) Universal input: resetting, EDM (external device monitoring), sleep mode, restarting the device Universal output: contamination, error, reset required, monitoring result (warning field)
8	FE	Functional earth/shield

7 Configuration

7.1 Delivery state

The device is not configured in the delivery state.

7.2 Safety Designer configuration software

The safety laser scanner is configured using the Safety Designer.

For information on the Safety Designer, see the operating instructions for the Safety Designer item no. 8018178.

7.2.1 Installing Safety Designer

Prerequisites

- Your Windows user account has rights for installing software.

Procedure

1. Call up the download web page and enter **Safety Designer** in the search field on www.sick.com.
2. Take note of the system requirements on the download page.
3. Download the installation file from the download page. Extract it and run it.
4. Follow the notes from the setup assistant.

Complementary information

The SQL CE database is required to open legacy projects with the **.sdp** ending. When installing Safety Designer, you can select whether SQL CE should be installed for compatibility of legacy projects.



NOTICE

The SQL CE database is not a trustworthy source. The installation of untrustworthy sources may pose a safety risk.

- ▶ Only install SQL CE if you have to convert legacy projects.
-

7.2.2 Projects

Using Safety Designer, you can configure one or more devices in a project. You can save the configuration data in a project file on the computer.

Creating a project

- ▶ Click on **Create new project**.
- ✓ This creates and opens an empty project.

Configuring a device online (device connected to computer)

The following interfaces are suitable for configuration:

- USB ⁵⁾

If a device is connected to the computer, Safety Designer can establish a connection to the device.

You will then configure the device online. In this case, you can transfer the configuration to the devices directly and use diagnostic functions.

⁵⁾ The USB connection may only be used temporarily and only for configuration and diagnostics.

- ▶ Click on **Connect**.
- ✓ Safety Designer searches for connected devices, with which it can establish a connection.

Configuring a device offline (device not connected to computer)

If the device is not connected to the computer, select it from the device catalog.

You will then configure the device offline. Diagnostics functions are not available.

You can connect the computer to the device later, assign a device to the device tile, and transfer the configuration to the device.

7.2.2.1 Saving verified configuration

When you save a project, information is saved for each device as to whether the configuration is verified. When you open a project file, each device tile and the **Overview** dialog box of the device window show whether the configuration is verified.

You can transfer a verified configuration to the same or an identical device again.

7.2.3 User interface

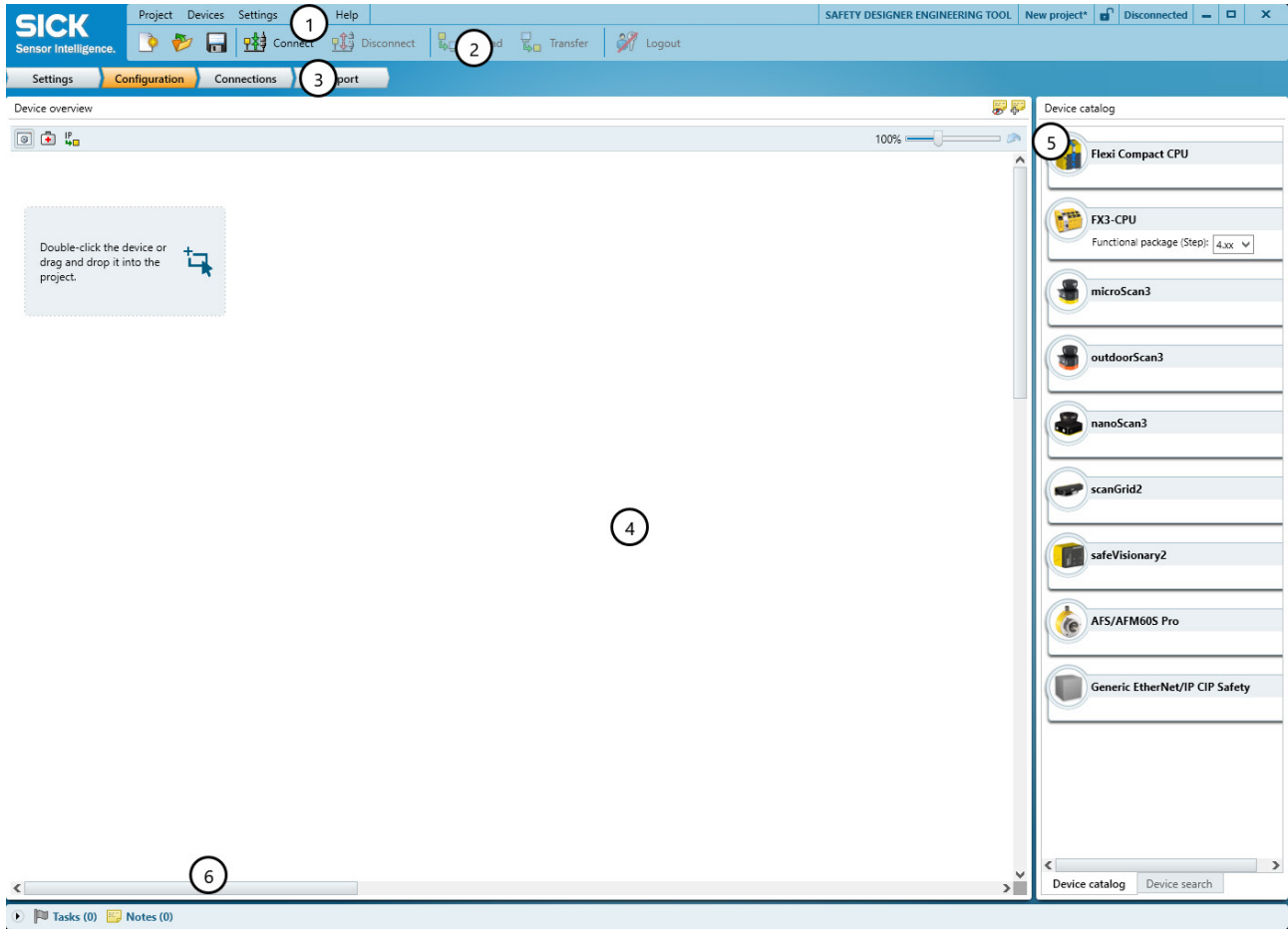

Figure 51: Software controls

- ① Menu bar
- ② Toolbar
- ③ Main navigation
- ④ Working range
- ⑤ Device catalog
- ⑥ Task list and notes

7.2.4 User groups

Overview

The devices contain a hierarchy of user groups that regulate access to the devices.

For certain actions (e.g., transferring a configuration to the device), you are requested to log onto the device with the respective user group.

Depending on the device, 3 or 4 user groups are available.

Important information



NOTICE

When you log into a device, the configuration software stores the password so that you do not need to re-enter it for other configuration steps.



If you do not change any other settings in the login dialog, the password is deleted as soon as you exit the configuration software, or log out in the main window or Device window.

If you enable the **Temporarily store password for login on additional devices.** function, the password will be retained even if you log out in the device window only.

If you leave the computer unattended, you must log off to prevent unwanted access to the device.



Device with 3 user groups



Table 6: User groups

User group	Password	Authorization
 Operator	Does not need a password (anyone can log in as a machine operator).	<ul style="list-style-type: none"> • May read configuration from the device (if not blocked).
 Maintenance personnel	Does not have a factory-set password. The password is created by the authorized client (namely, it is not possible initially to log in as a maintenance technician).	<ul style="list-style-type: none"> • May read configuration from the device. • May transfer verified configuration to the device.
 Authorized client	The password SICKSAFE is created at the factory. Change this password to protect the device against unauthorized access.	<ul style="list-style-type: none"> • May read configuration from the device. • May transfer verified and unverified configuration to the device. • May verify configuration. • Can set a password for maintenance technicians.

Device with 4 user groups

Table 7: User groups

User group	Password	Authorization
 Operator	No password required. Anyone can log on as a machine operator.	<ul style="list-style-type: none"> • May read configuration from the device.
 Maintenance personnel	Deactivated ex-works, i.e. it is not initially possible to log on as a maintenance technician. The user group can be activated by the user group administrator and provided with a password.	<ul style="list-style-type: none"> • May read configuration from the device. • May transmit verified configuration to the device. • Change own password allowed.

User group	Password	Authorization
 Authorized client	Deactivated ex-works, i.e. it is not initially possible to log on as an authorized customer. The user group can be activated by the user group administrator and provided with a password.	<ul style="list-style-type: none"> • May read configuration from the device. • May transmit verified and unverified configuration to the device. • May verify configuration. • Resetting the safety function and communication settings to factory defaults is allowed. • Change own password allowed. • Changing the password of the Maintenance personnel user group is allowed.
 Administrator	The password SICKSAFE is created at the factory. <ul style="list-style-type: none"> ▶ Change this password to protect the device against unauthorized access. 	<ul style="list-style-type: none"> • May read configuration from the device. • May transmit verified and unverified configuration to the device. • May verify configuration. • Resetting whole device to factory settings allowed. • Activating and deactivating device functions is allowed. • Activating and deactivating the Maintenance personnel and Authorized client user groups is allowed. • Change own password allowed. • Changing the passwords of the Maintenance personnel and Authorized client user groups is allowed.

Complementary information

The maintenance engineer is permitted to reset the safety function to factory settings.

The configuration of the device is saved in the system plug. Therefore, the passwords are retained when the device is replaced if the system plug is still used.

Further topics

- ["Version numbers and functional scope", page 143](#)

7.2.5 Settings

Information on the functionality and basic operation of the software and on the settings in the main window can be found in the operating instructions of the Safety Designer (part number 8018178).

7.2.6 Configuration

You collect the devices of a project in the **Configuration** area. The available devices can be found in the Device Catalog. The devices are displayed as Device tiles in the working range.

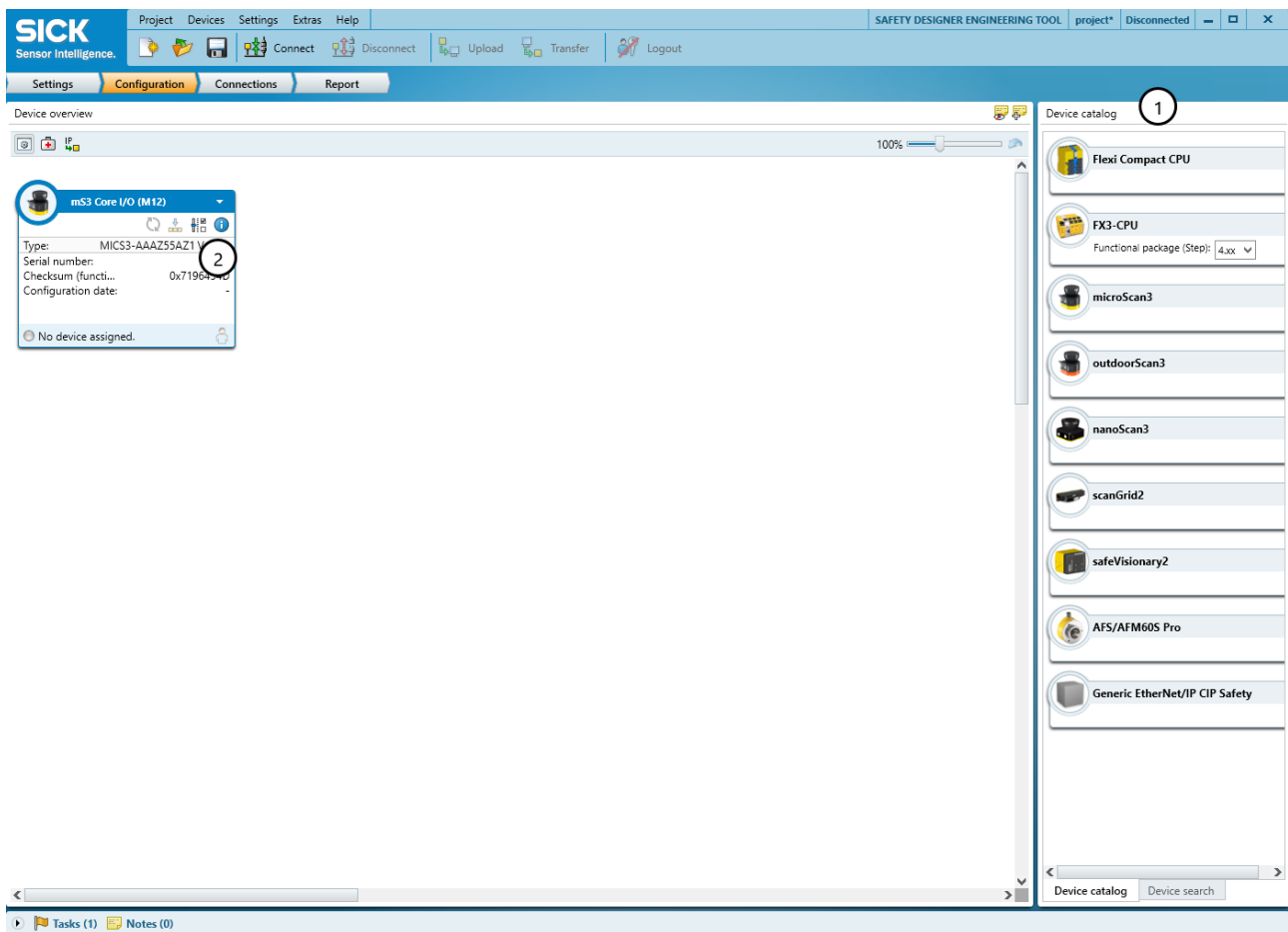

Figure 52: Configuration

- ① Device Catalog
- ② Device tile

7.2.6.1 Device Catalog

Overview

The device catalog contains all available devices:

- The **Device catalog** tab contains the devices installed in Safety Designer.
- The **Device search** tab contains the devices found during a device search.

Procedure

The devices from the device catalog can be added to a project in the workspace:

- ▶ Drag a device into the working area using drag and drop.
Or:
- ▶ Double-click on a device in the device catalog.
- ✓ The device is shown as a tile in the working area.

Complementary information

When a device is configured offline for the first time, the device selection wizard opens for devices with multiple variants (device types). This is where you select the exact type of device to be configured.

7.2.6.2 Open the device window – configure devices

Overview

To configure the device, perform diagnostics or create reports, open a device window.

Procedure

You have the following options:

- ▶ Double-click on the Device tile.
Or:
- ▶ Open the tile menu and choose **Configure**.
- ✓ The device window opens.

Complementary information

When a device is configured offline for the first time, the device selection wizard opens for devices with multiple variants (device types). This is where you select the exact type of device to be configured.

7.2.7 Networking

Information on the functionality and basic operation of the software and on the settings in the main window can be found in the operating instructions of the Safety Designer (part number 8018178).

7.3 Overview

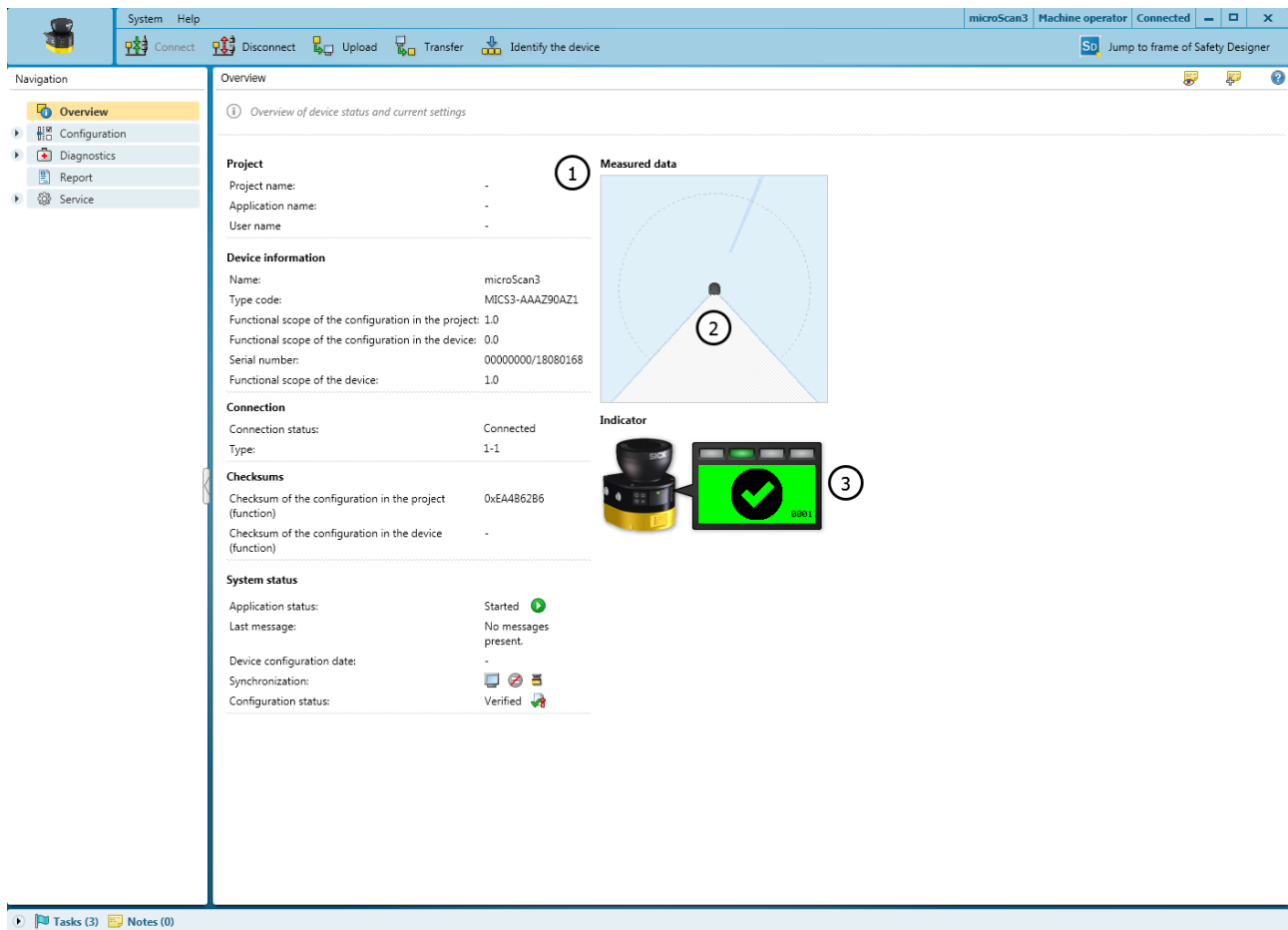

Figure 53: Overview

- ① Device information
- ② Current measurement data
- ③ Display with device status

The **Overview** dialog box contains information about the safety laser scanner.

Project

- Project name: the same name should be chosen for all devices in the project
- Application name: this name can be the same for a number of devices in the project. It highlights that these devices realize an application together, by responding to one another for example.

Device information

- Name, identifies the specific device
- Type code of the safety laser scanner
- Functional scope of the configuration in the project
- Functional scope of the configuration in the device
- Serial number of the safety laser scanner
- Functionality of the device
- Part number
- Revision

Connection

- Connection status
- Type of connection

Checksums

A checksum is used as a unique identification for a configuration. Using the checksum, it is possible to work out whether a setup was changed or whether two devices have the same configuration.

The checksum of the configuration in the project may not match the checksum in the device, for example if a field geometry has been modified, but not yet transmitted to the device.

System status

- Application status
- Current notification of the safety laser scanner
- Configuration date for the configuration in the device
- Synchronization: shows whether the configuration in Safety Designer and the configuration in the device are identical
- Verification status of the configuration in the project
- Verification status of the configuration in the device

Measurement data

Shows the measurement data when a device is connected.

Display

Shows the status of the display and LEDs when a device is connected.

Establishing connection

1. Check whether the safety laser scanner is connected correctly.
 2. Click on **Connect** in the toolbar.
- ✓ Safety Designer establishes the connection to the safety laser scanner.

7.3.1 Functional scope

Older versions of the Safety Designer potentially do not support the full functionality of the latest devices. Vice versa, older devices might not support the full functionality of the latest Safety Designer.

To identify the different levels of the functionality, we use a 3-digit version number. The version number is marked with the letter V on the device.

A configuration in the Safety Designer or in a system connector must match the device for which it is to be used. If the configuration fits, it can be transferred from the Safety Designer to the device and the system connector with the configuration can be used for the device.

The configuration matches the device if the following points apply:

- The 1st digit of the two version numbers must be identical.
- The 2nd digit of the version numbers on the device must be at least as large as that of the configuration in Safety Designer or in the system plug.
- The 3rd digit is not relevant for compatibility.

The functional scope of the device can be read at the following locations:

- Label on the device
- Display, entry in **Device info** menu at **Hardware**
- Safety Designer, **Overview** dialog (only with connected device)
- Safety Designer, report



Figure 54: Functional scope

- ① Functional scope of the device

If you configure a device offline, you must define the functional scope of the configuration when adding the device in the device selection wizard in the Safety Designer.

If you add a device to the project via the device search, the functionality of the device will be carried over. If the device has already been configured, the functional scope of the configuration is adopted in the device.

Further topics

- ["Version numbers and functional scope", page 143](#)

7.4 Reading configuration

Overview

At the left, you see the values configured in the project for the device. If the device is connected, you see the values saved in the device at the right.

If the values in the project and the values in the device differ, you can read the values out from the device and adopt them in the project.

Procedure

1. Click on **Read from device**.
- ✓ The values are read from the device and adopted in the project.

Complementary information

Configuration:

- **Name**
If a number of devices are used in an application or in a project, a unique device name helps to tell the individual devices apart.
- **Checksums**
A checksum is used as a unique identification for a configuration. Using the checksum, it is possible to work out whether a setup was changed or whether two devices have the same configuration.
The checksum of the configuration in the project may not match the checksum in the device, for example if a field geometry has been modified, but not yet transmitted to the device.

7.5 Identification

Overview

The screenshot shows the 'Identification' dialog box in the Safety Designer software. The dialog has a title bar with 'microScan3 Machine operator Isolated' and a 'Jump to frame of Safety Designer' button. The main area is titled 'Identification' and contains a 'Project' section with input fields for 'Device name' (containing 'microScan3'), 'Project name', 'Application name', 'User name', and 'Description'. An 'Application image' field with a camera icon is also present. A circled '1' highlights the 'Device name' field. At the bottom, there are 'Tasks (1)' and 'Notes (0)' tabs.

Figure 55: Identification

① Parameters for the project and the device

In the **Identification** dialog box, you can optionally enter names and information to uniquely identify the application, project, and devices.

Device name

If a number of safety laser scanners are used in an application or in a project, a unique device name helps to tell the individual devices apart.

- ▶ Give each device a unique device name.

Project name

The project name is used to identify an entire project. The same project name should be chosen for all devices in the project.

- ▶ Enter a project name.

Application name

The application name can be the same for a number of devices in the project. It highlights that these devices realize an application together, by responding to one another for example.

- ▶ Enter an application name.

User name

The optional user name helps later users to find a contact for the application.

- ▶ Enter a user name.

Application image

An image helps to identify the application more quickly. The application image is saved in the project file on the PC and transmitted to the device. The Safety Designer supports the following file formats: BMP, GIF, JPG, PNG, TIF.

1. Click on the pencil icon.
 2. Select an image file for the application.
- ✓ The image is incorporated as a thumbnail.

Description

A description makes it easier to understand an application's context more quickly.

- ▶ Enter a description with a maximum of 1000 characters.

7.6 Application

Overview

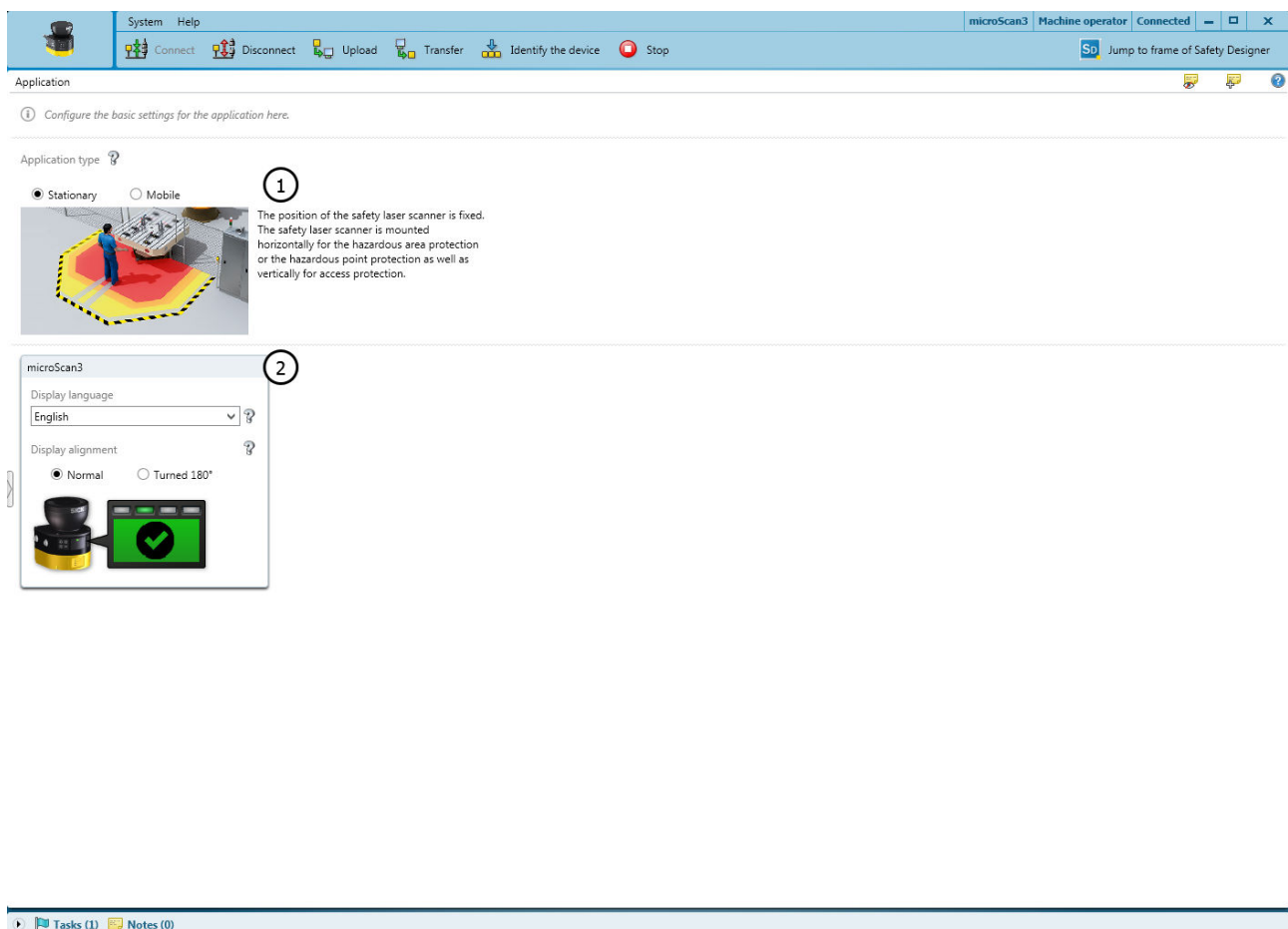

Figure 56: Application

- ① Basic settings for the application
- ② Settings for the display

Application type

The type of application depends on the application of the safety laser scanner:

- ▶ Select application type.
- ✓ **Mobile**
Mobile hazardous area protection is suitable for AGVs (automated guided vehicles), cranes, and forklifts to protect people when vehicles are moving or docking. The safety laser scanner monitors the area in the direction of travel and stops the vehicle as soon as an object is located in the protective field.
- ✓ **Stationary**
The position of the safety laser scanner is fixed. The safety laser scanner is mounted horizontally (for hazardous area protection) or vertically (for hazardous point protection and access protection).

Display language

The display of the safety laser scanner outputs notifications and states. Multiple languages are available for the display.

- ▶ Select a language that the operator understands.
- ✓ The safety laser scanner outputs the notifications in the set language.

Display alignment

If you mount the safety laser scanner with the optics cover downward, you can rotate the orientation of the display through 180°. The preview shows the selected orientation of the display.

- ▶ Choose the **Normal** or **Upside down** option to specify the display orientation.
- ✓ The preview shows the display's orientation.

7.7 Monitoring plane

Overview

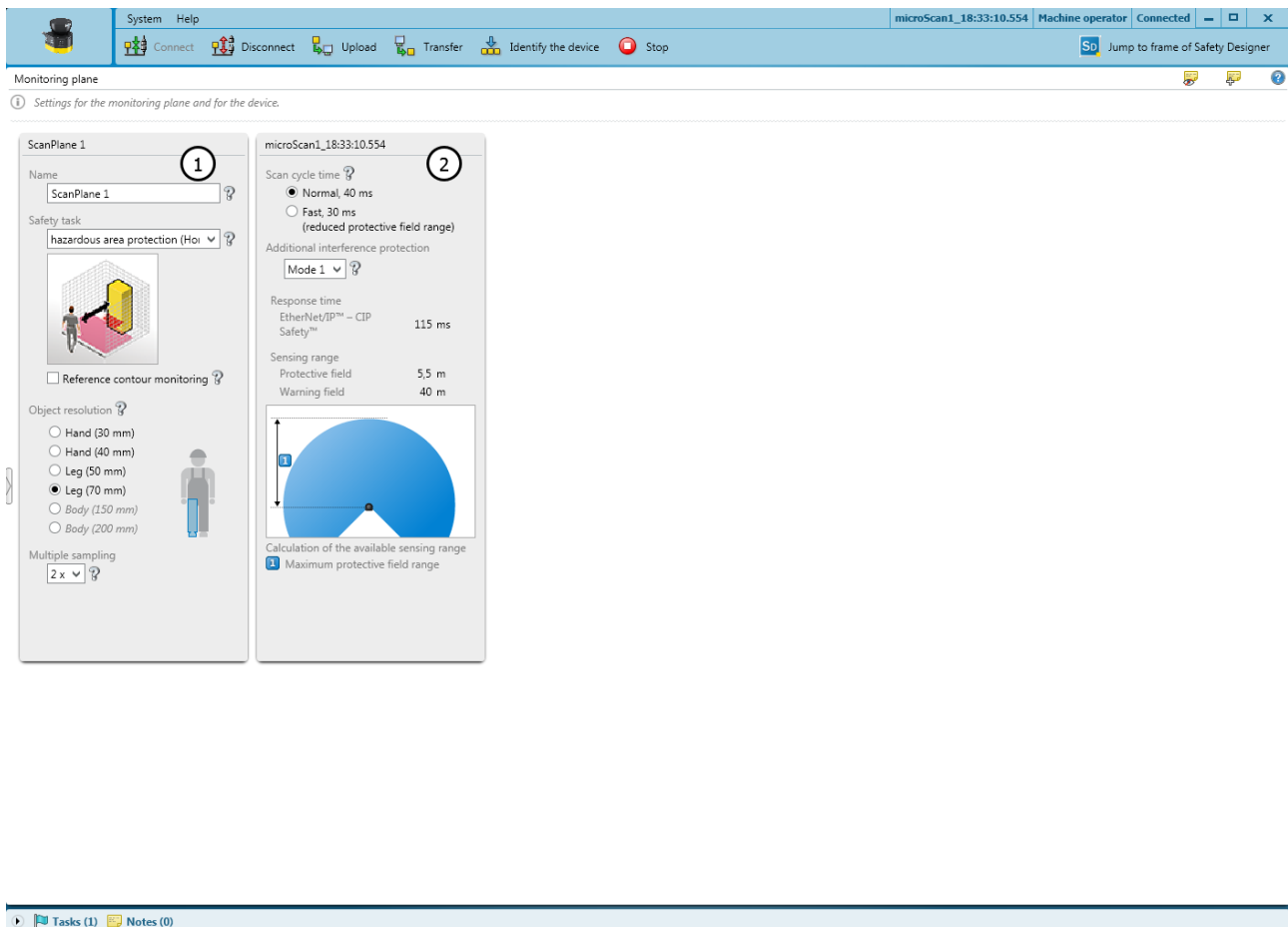

Figure 57: Monitoring plane

- ① Parameters for the monitoring plane
- ② Parameters for the safety laser scanner

The scan plane of a safety laser scanner forms its monitoring plane.

This dialog is used to define the following parameters:

- Parameters for the monitoring plane
- Parameters for the safety laser scanner

7.7.1 Parameters for the monitoring plane

Overview

Configure a name, the protection task, object resolution, and multiple sampling setting for the monitoring plane.

At first, the object resolution and multiple sampling configured for the monitoring plane apply for all fields. If necessary, make changes to each individually at a later date. If you do this, Safety Designer will indicate this in the settings for the monitoring plane.

Name

You can use the name to identify monitoring planes when creating fields and monitoring cases and also in reports.

- ▶ Enter a descriptive name for the monitoring plane (e.g., “Hazardous area on the right hand side”).
- ✓ The name is used to identify the monitoring planes.

Safety task

People approach the monitoring plane parallel or orthogonally, depending on the orientation of the protective field in your application (see ["Project planning", page 24](#)).

- **Hazardous area protection (Horizontal)**
Typically, for a horizontal approach, the requirement is to detect the leg. The typical object resolution is leg (70 mm).
- **Access protection (Vertical)**
Typically, for access protection, the requirement is to detect a person. The typical object resolution is body (200 mm).
- **Hazardous point protection (Vertical)**
Typically, for hazardous point protection, the requirement is to detect a hand. The typical object resolution is hand (40 mm).

Reference contour monitoring



NOTE

If the monitoring plane has a vertical alignment, a contour (such as the floor, a part of the machine bed, or an access threshold) must typically be defined and monitored as a reference contour. A reference contour field is used for this, see ["Reference contour field", page 90](#).

- ▶ Activate the **Reference contour monitoring** option.
- ✓ The **Reference contour field** item is shown in the navigation. Here you can configure the reference contour field required for your application.

Object resolution

The object resolution defines the size that an object must be to allow it to be reliably detected. The following object resolutions are available:

- 30 mm = hand detection
 - 40 mm = hand detection
 - 50 mm = leg detection/arm detection
 - 60 mm = leg detection/arm detection (depends on variant)
 - 70 mm = leg detection/arm detection
 - 150 mm = body detection
 - 200 mm = body detection
- ▶ Choose the object resolution.
 - ✓ Objects the same size as or larger than the chosen object resolution are reliably detected.



NOTE

The configurable object resolution has an influence on the protective field range available. The finer the object resolution configured for the safety laser scanner, the shorter the available protective field range.

The protective field range is shown to you, see ["Parameters for the safety laser scanner", page 88](#).

Multiple sampling



DANGER

Hazard due to lack of effectiveness of the protective device

Persons or parts of the body to be protected may not be recognized or not recognized in time in case of non-observance.

A higher multiple sampling increases the response time.

- ▶ Make a note of the new response time of the safety laser scanner in Safety Designer.
- ▶ Adjust the minimum distance from the hazardous point to the new response time.

Multiple sampling indicates how often an object has to be scanned before the safety laser scanner responds. A higher multiple sampling reduces the possibility that insects, weld sparks or other particles cause the machine to be shut down. You will increase the machine's availability.

A multiple sampling of 2 is the minimum setting.

- ▶ Increase the multiple sampling up to 16.
- ✓ An object must be this many times.

Table 8: Recommended multiple sampling

Application	Recommended multiple sampling
Stationary application: such as horizontal hazardous area protection or vertical hazardous point protection under clean ambient conditions	2x
Stationary application: such as vertical access protection Only 2-time multiple sampling may be used for vertical access protection.	2x
Mobile application	4x
Stationary application: such as horizontal hazardous area protection under dusty ambient conditions	8x

Multiple sampling after monitoring case switching



DANGER

Hazard due to lack of effectiveness of the protective device

If combined with very short switchover times, higher multiple sampling after switching between monitoring cases can result in a person or part of their body not being detected.

- ▶ Make sure that every monitoring case is active for at least the amount of time required for detection by the safety laser scanner (setting for multiple sampling after monitoring case switching multiplied by the configured scan cycle time including the supplement due to interference protection).

When switching between monitoring cases, it is possible that a person may already be in the newly activated protective field when switching takes place. In order to ensure that the person is detected quickly and the dangerous state is brought to an end swiftly, you can adjust the settings for multiple sampling immediately after switching between monitoring cases – regardless of any other multiple sampling in place.

- **Fast (1 scan)** (default setting): Multiple sampling after monitoring case switching $n_{CS} = 1$. An object needs to be scanned once before the safety laser scanner responds. Fastest response and safest behavior of the safety laser scanner.
- **Robust (multiple sampling - 1)**: Multiple sampling after monitoring case switching $n_{CS} = n - 1$. Multiple sampling after switching between monitoring cases is one scan fewer than any other multiple sampling in place. This reduces the possibility that insects, weld sparks, or other particles cause the machine to be switched off. This increases machine availability. The standard response time applies from the outset in the new field.
- **User-defined (please consult manual)**: You can adjust the settings for multiple sampling after monitoring case switching in line with your requirements on response time and reliability. Regardless of the exact settings here, multiple sampling after switching between monitoring cases is always at least one scan fewer than any other multiple sampling in place: $n_{CS} \leq n - 1$

Multiple sampling after object detection

The set multiple sampling also applies by default if a field becomes free again after an object detection. That means, when the field is free again, the free field is scanned the same number of times until the safety outputs switch back to the ON state.

If you activate the **Activate different multiple sampling rate after object detection** option, you can specify deviating values for the monitoring level or for individual fields. This may cause the outputs to switch back to the ON state faster or slower after a field has become free again.

The following case is only relevant if multiple sampling or different multiple sampling rate after object detection is set to a value $n < 6$: Regardless of whether a different multiple sampling rate after object detection is set, the multiple sampling after object detection will in some circumstances be increased to a value up to $n = 6$. This case arises if an object detection lasts for a longer period, i.e. if it takes a long time until the field is clear again.

7.7.2 Parameters for the safety laser scanner

Overview

This is where you configure the parameters for the safety laser scanner.

Scan cycle time

You can configure the scan cycle time. The scan cycle time of the safety laser scanner affects the response time and the protective field range.

Devices with a max. protective field range of 4.0 m and devices with max. protective field range of 5.5 m:

- 40 ms: Full protective field range, increased availability in dusty conditions, for example
- 30 ms: Smaller protective field range with shorter response time

Devices with a max. protective field range of 9.0 m:

- 50 ms: Full protective field range, increased availability in dusty conditions, for example
- 40 ms: Smaller protective field range with shorter response time

- ▶ Select scan cycle time.
- ✓ The resulting response time and the range of the fields are shown.

Additional interference protection

If you mount several safety laser scanners in close proximity to each other, this can lead to mutual interference. You will prevent mutual interference in neighboring safety laser scanners if you choose different settings for interference protection.

Modes 1 to 4 are available. Interference protection influences the scan cycle time and therefore the response time.

- Mode 1 = + 0 ms per scan cycle
 - Mode 2 = + 1 ms per scan cycle
 - Mode 3 = + 2 ms per scan cycle
 - Mode 4 = + 3 ms per scan cycle
- ▶ Configure a different mode for each safety laser scanner that is mounted in close proximity.
- ✓ The resulting response time is shown.

Complementary information



NOTE

The response time of the safety laser scanner depends on the scan cycle time, interference protection, and multiple sampling, see ["Response times", page 151](#). In addition to the response time of the safety laser scanner, further signal transmission and processing also influence the time until the end of the dangerous state.

A graphic shows how the configuration affects the available ranges.

7.8 Reference contour field

Overview

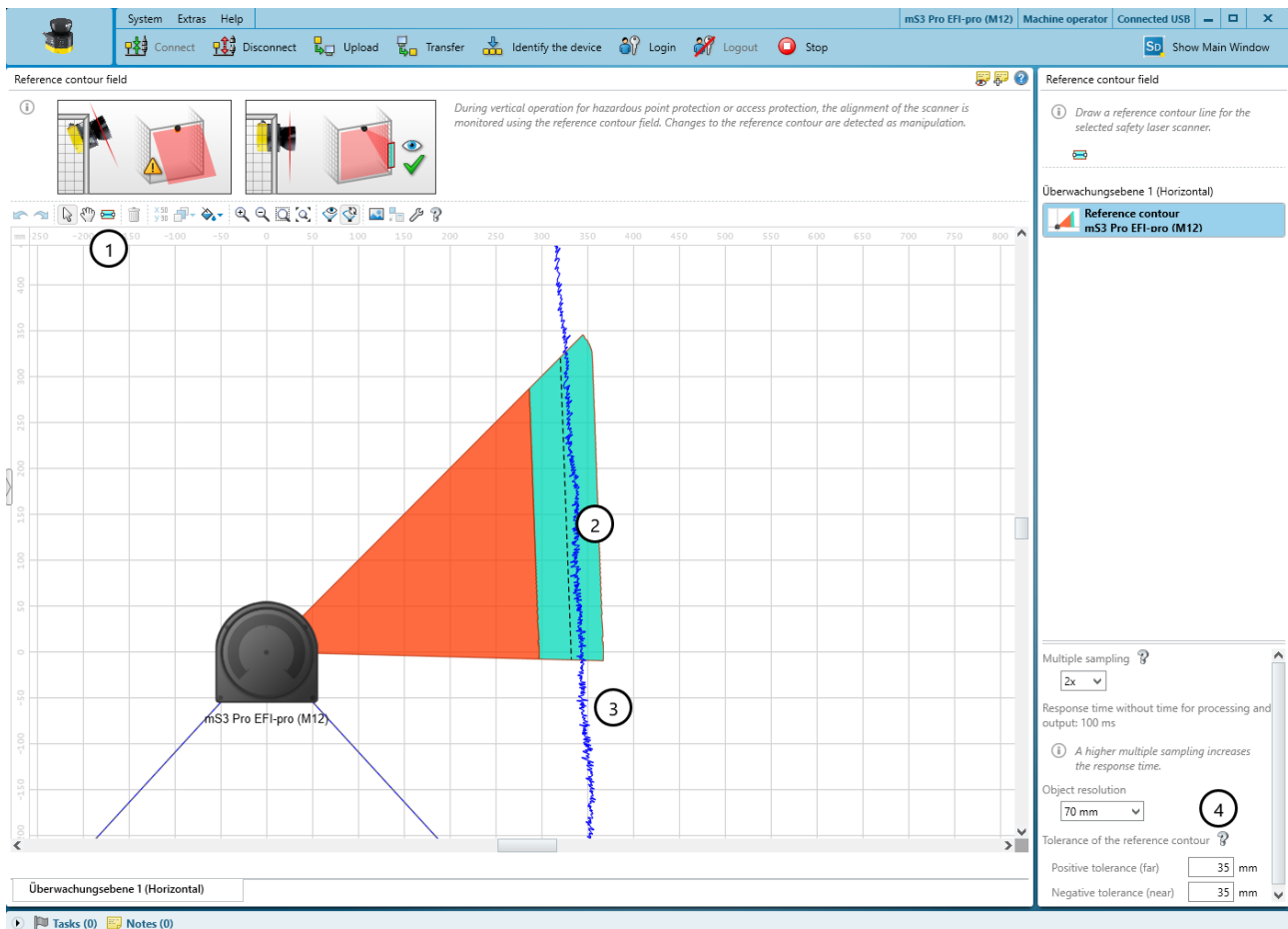

Figure 58: Reference contour field

- ① Tool for drawing reference contour fields
- ② Drawn contour with tolerance band
- ③ Visible spatial contour
- ④ Configure the field

If you have activated the **Reference contour monitoring** option for a monitoring plane, the **Reference contour field** dialog box is displayed. Draw the reference contour field based on the values determined during project planning (see "[Reference contour monitoring](#)", page 29).

The contour as reference field monitors a contour of the environment. The safety laser scanner switches all safety outputs to the OFF state if a contour does not match the set parameters, because, for example, the mounting of the safety laser scanner has been changed.

Drawing a reference contour field

1. Select the tool for drawing reference contour fields.
2. Draw a line along the spatial contour as a reference.
 - ▶ First, use the mouse to click the desired contour.
 - ▶ Click to add the corners of the contour.
 - ▶ Finally, double-click the contour.
- ✓ The reference contour field is displayed.

Multiple sampling and Object resolution



DANGER

Hazard due to lack of effectiveness of the protective device

Persons or parts of the body to be protected may not be recognized or not recognized in time in case of non-observance.

A higher multiple sampling increases the response time.

- ▶ Make a note of the new response time of the safety laser scanner in Safety Designer.
- ▶ Adjust the minimum distance from the hazardous point to the new response time.

Safety Designer initially uses multiple sampling and the object resolution of the monitoring plane for the fields.

If necessary, define multiple sampling and the object resolution for each field individually.

1. Select multiple sampling.
 - ✓ Multiple sampling indicates how often an object has to be scanned before the safety laser scanner responds.
2. Select object resolution.
 - ✓ The object resolution defines the size that an object must be to allow it to be reliably detected.

Tolerance band

A contour has a positive and a negative tolerance band. The cut-off path goes to the OFF state if the safety laser scanner does not detect the contour inside the tolerance band.

- ▶ Enter **Positive tolerance (far)**.
 - ✓ The tolerance away from the safety laser scanner is defined.
- ▶ Enter **Negative tolerance (near)**.
 - ✓ The tolerance toward the safety laser scanner is defined.

7.9 Fields

Using the field editor, you can configure the field sets of the safety laser scanner. The number of configurable fields depends on the safety laser scanner variant.

The edge length or the diameter of each field must be at least as large as the selected object resolution.

7.9.1 Using the field editor

Overview

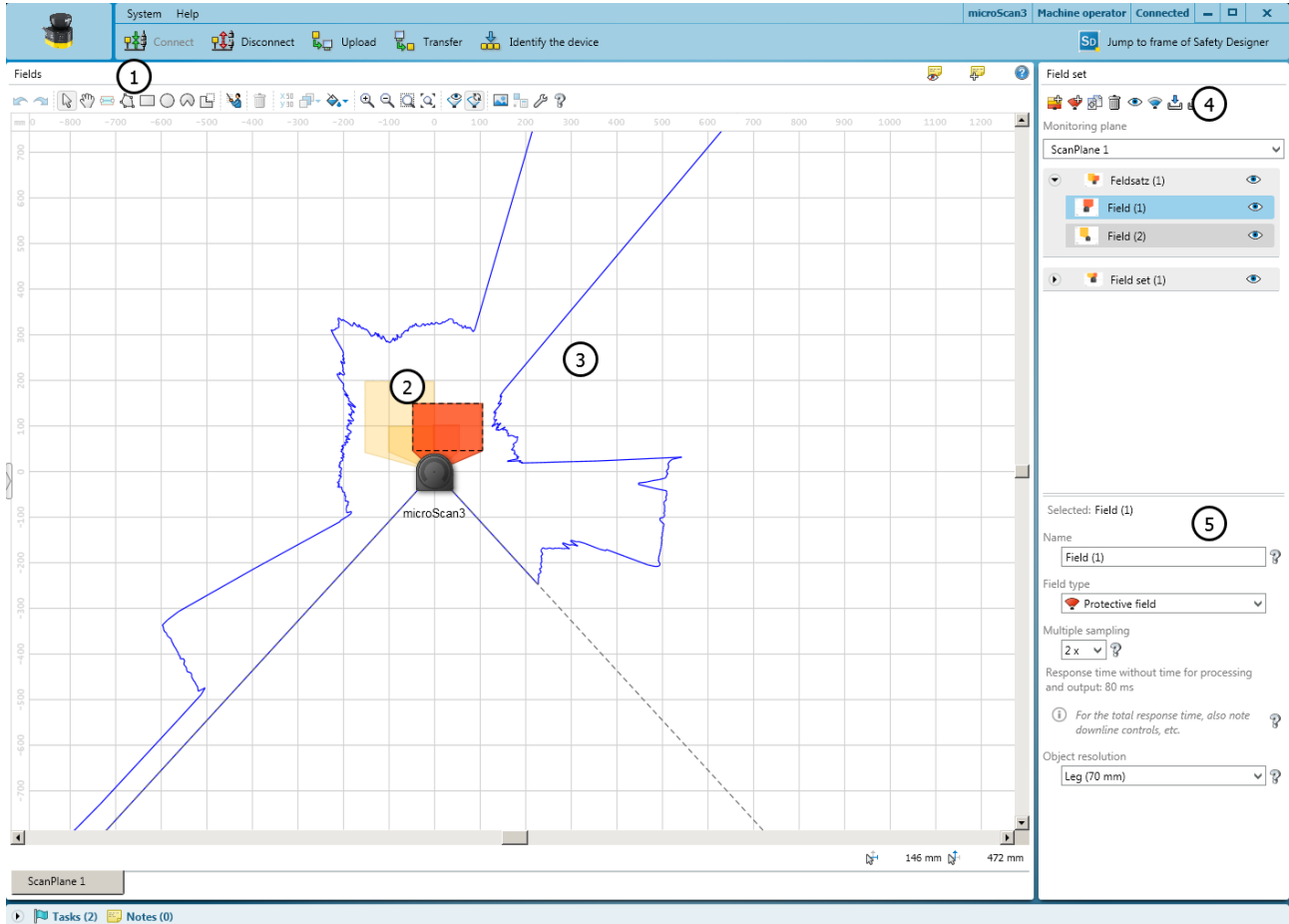

Figure 59: Field editor





- ① Toolbar
- ② Protective field (red) and warning field (yellow) created
- ③ Visible spatial contour
- ④ Create, duplicate, delete field set and fields
- ⑤ Define field type, name field, configure field



















In the **Fields** area, you draw the fields in a field set using the tools in the toolbar. In the **Field set** area, you create the field sets and fields. In the area below, you can define the field type, enter the name and, configure multiple sampling and the object resolution, if necessary.

Toolbar

Using the tools in the field editor, you can draw the fields in a field set or masked areas inside the fields.

Table 9: Buttons on the toolbar



	Arrow tool, for marking objects
	Hand tool, for moving the work space
	Draw reference contour field or contour detection field
	Draw field using points

-  Draw rectangle
-  Draw circle
-  Draw circle segment
-  Mask areas (see "Drawing in points that cannot be monitored", page 99). Use the drawing functions for fields to draw the masked areas. The buttons are crosshatched.
- 
-  Enable propose field
-  Edit a field using coordinates (see "Editing fields using coordinates", page 98)
-  Push the object into the foreground or background
-  Select field design
-  Calculate field
-  Zoom in
-  Zoom out
-  Zoom to area
-  Zoom to work space
-  Show snapshot of the spatial contour. Clicking again clears the spatial contour shown.
-  Show live spatial contour
-  Paste background image (see "Background image", page 96)
-  Open field editor settings

Field display

Safety Designer displays the field types in different colors.

Table 10: Colors of the field types

Protective field	Warning field	Reference contour field and contour detection field
		
Red	Yellow	Turquoise

Create fields and field sets











NOTE

You can only create the number of fields and field sets allowed in the performance package of the safety laser scanner. If the maximum number of fields and field sets has already been used, it is not possible to create any more fields or field sets.

You can change the sequence of the fields in the **Field set** area using drag and drop. The fields of a field set are displayed in the monitoring case table in the same sequence in which you create them here.

If you choose, e.g., protective field, warning field, the protective field acts on cut-off path 1 and the warning field acts on cut-off path 2.

Table 11: Buttons for field sets

	Add field set
	Add field to field set
	Duplicate field set
	Delete field or field set
	Hide or show field sets and fields
	Manage field set templates (see "Creating field set templates", page 95)
	Import field sets and fields
	Export field sets and fields

Add field set:

1. Select **Add field set**.
- ✓ A field set containing one field is created.
2. Enter a unique name for the field set under **Name**.
3. Add further fields to the field set, if necessary.

Add field:

1. Select the field set to which you would like to add a field.
2. Click on **Add field to field set**.
- ✓ Another field is added to the selected field set.

Duplicate field set:

1. Select the field set which you would like to duplicate.
2. Click on **Duplicate field set**.
- ✓ The field set is duplicated and pasted in as a copy.

Manage field set templates:

1. Click on **Manage field set templates**.
- ✓ The available templates are shown.
2. Edit the field set template or create a new field set template (see "Creating field set templates", page 95).

Name and Field type

Assign a unique name and select a field type for each field. Change the multiple sampling or the object resolution of a field, if required.

1. Select the field to be edited.
2. Enter the name of the field.
3. Select the field type see "Field types", page 17.

Multiple sampling and Object resolution



DANGER

Hazard due to lack of effectiveness of the protective device

Persons or parts of the body to be protected may not be recognized or not recognized in time in case of non-observance.

A higher multiple sampling increases the response time.

- ▶ Make a note of the new response time of the safety laser scanner in Safety Designer.
- ▶ Adjust the minimum distance from the hazardous point to the new response time.

Safety Designer initially uses multiple sampling and the object resolution of the monitoring plane for the fields.

If necessary, define multiple sampling and the object resolution for each field individually.

1. Select multiple sampling.
 - ✓ Multiple sampling indicates how often an object has to be scanned before the safety laser scanner responds.
2. Select object resolution.
 - ✓ The object resolution defines the size that an object must be to allow it to be reliably detected.

Tolerance band

A contour has a positive and a negative tolerance band. The cut-off path goes to the OFF state if the safety laser scanner does not detect the contour inside the tolerance band.

- ▶ Enter **Positive tolerance (far)**.
 - ✓ The tolerance away from the safety laser scanner is defined.
- ▶ Enter **Negative tolerance (near)**.
 - ✓ The tolerance toward the safety laser scanner is defined.

Name

Assign a unique name for each field set.

1. Select the field set to be edited.
2. Enter the name of the field set.

7.9.2 Creating field set templates

If you require the same combination of fields a number of times, you can create a field set template.

 You can edit field set templates using the **Manage field set templates** tool.

Example: you define a field set template with protective field, warning field1 and warning field2.

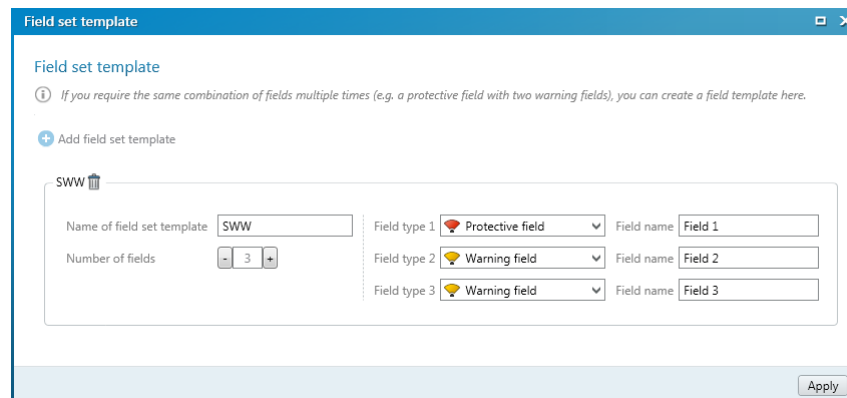

Figure 60: Field set template

Procedure

1. Click on **Add field set template**.
2. Enter the name for the template.
3. Define the number of fields.
 - ✓ A selection field is shown for each field.

4. Select the Field types for the fields.
5. Enter the Field names.
6. Click on **Apply**.
- ✓ The field set template is saved.

7.9.3 Importing and exporting field sets and fields

Overview

If you need identical field sets or fields across different projects, you can export entire field sets or individual fields out of one project and import them into another project.

Importing field sets and fields

1. Click on **Import fields and field sets**.
2. Select exported file with field set information.
- ✓ A preview of the field sets and fields saved in the file will be shown.
3. Select the required field sets and fields.
4. Start the import.
- ✓ The field sets and fields will be imported.

Exporting field sets and fields

1. Click on **Export fields and field sets**.
2. Select the relevant folder and enter a file name for storing the field set information.
3. Select the required field sets and fields.
4. Start the export.
- ✓ The field sets and fields will be exported.

7.9.4 Background image

You can select a background image for the field editor. For example, the plan view of the machine to be protected can be used as a sample.

The background image is saved in the project file on the PC. It is not transferred to the device.



You can use the **Edit background image** tool to choose a background image.

The Safety Designer supports the following file formats: BMP, JPG, PNG.

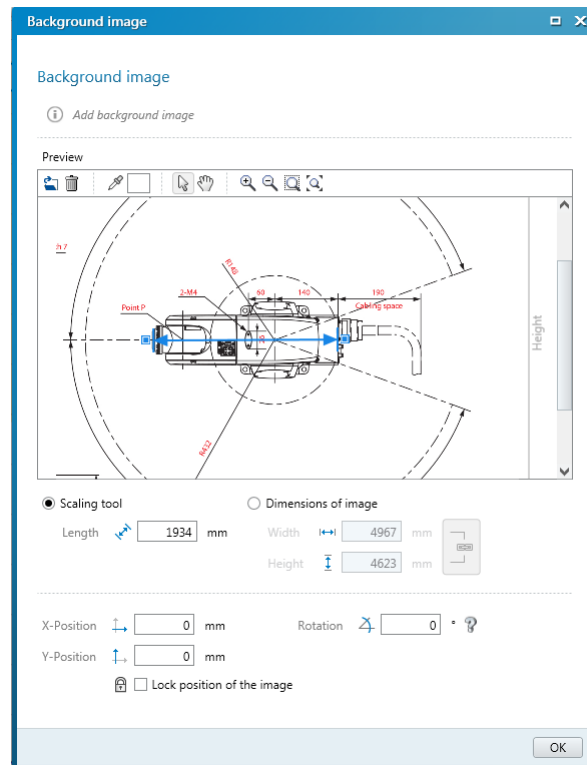

Figure 61: Background image

1. Click on **Edit background image** in the toolbar.
- ✓ The **Background image** dialog box opens.
2. Click on **Browse ...**
3. Select the file for the background image.
- ✓ Safety Designer displays the background image.
4. If necessary, use the pipette icon to select a color of the image to make this color transparent.
5. Adjust the size of the image with the scaling tool or by directly entering the dimensions. Use the scaling tool to move the tips of the blue arrow to two known points and then enter the distance between the points in the **Length** field.
6. Enter **X-Position**, **Y-Position** and **Rotation** in the coordinate system of the field editor. You can then freely move or rotate the background image in the field editor.
7. If necessary, click on the **Lock position of the image** option.
- ✓ It is no longer possible to change the background image in the field editor.

7.9.5 Settings for the field editor

Overview

Table 12: Settings for the field editor

	Edit field editor settings
---	-----------------------------------

Field calculation

You specify whether the fields are calculated manually or automatically after drawing.

If you select the **Manual** option, first draw the areas to be monitored. Then click on **Calculate field sets** so that the Safety Designer calculates the field that the safety laser scanner actually monitors.

If you select the **Automatic** option, the drawn areas are immediately converted into fields.

Use global geometry

You specify whether global geometries are used.

Display reference contour field

You determine whether the reference contour field is displayed.

Drawing surface

You can use a Cartesian or a polar coordinates system and select the colors for the grid, the labels, and the drawing area.

7.9.6 Editing fields using coordinates

You can use coordinates to edit fields. Depending on the form on which a field is based, the appropriate input fields are displayed. The example shows a dialog box for a rectangle.

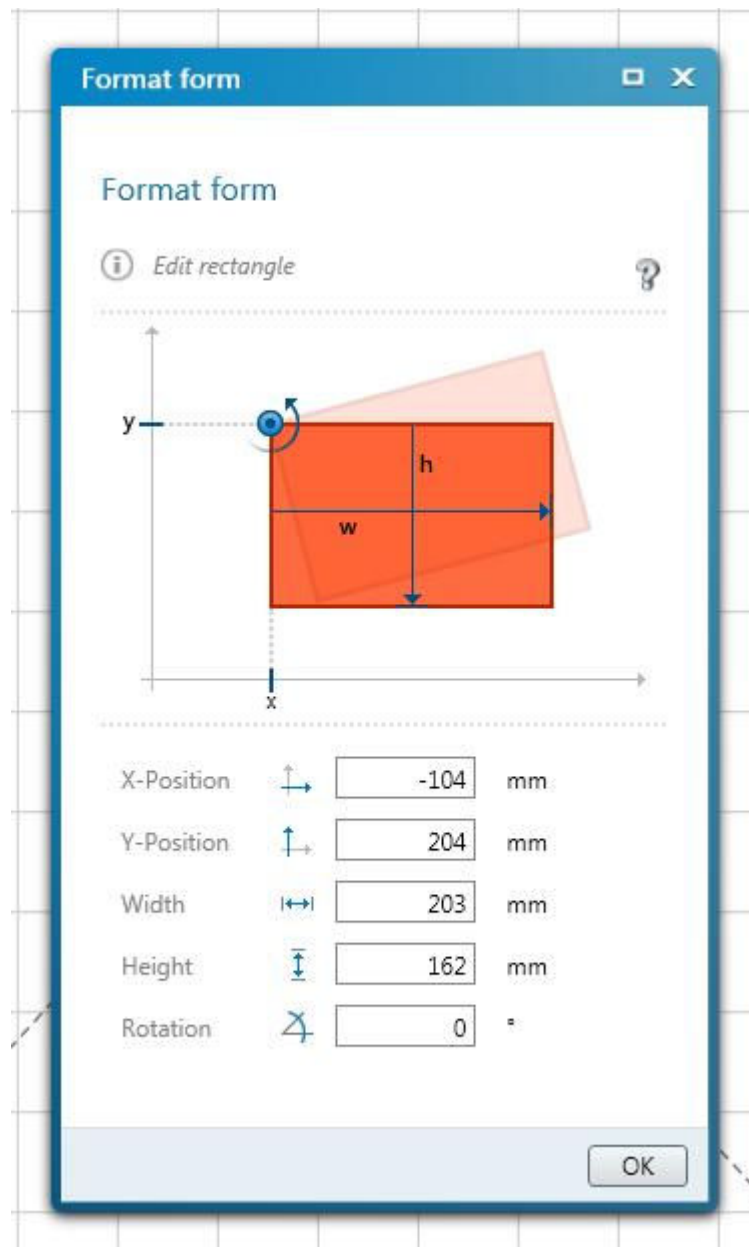

Figure 62: Editing fields using coordinates

The reference points for the X and Y values are as follows:

- Rectangle: top left corner
- Circle: center point
- Circle sector: center point
- Polygon: each point individually
- Contour line: each point individually

7.9.7 Drawing in points that cannot be monitored

Overview

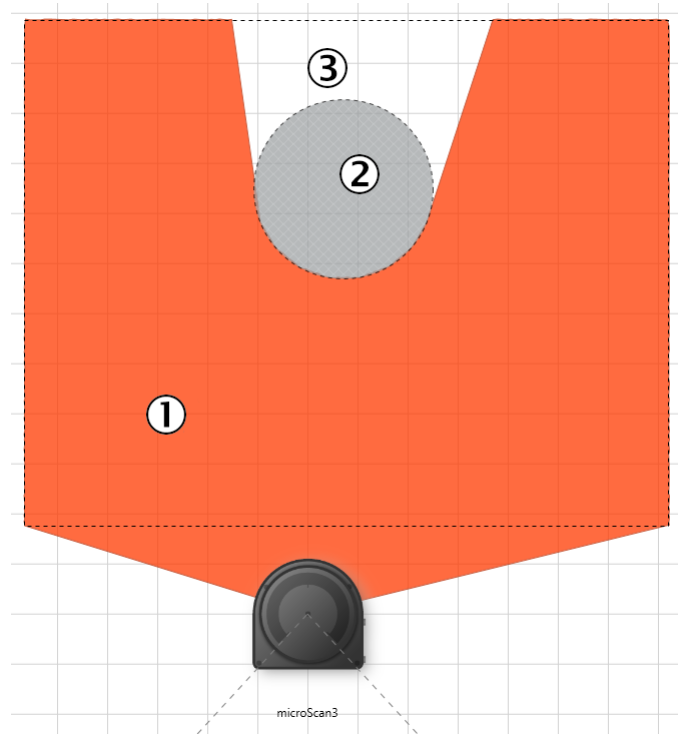



Figure 63: Area that cannot be monitored

- ① Protective field
- ② Marked column
- ③ Area that cannot be monitored

The area to be monitored is scanned radially ①. For this reason, shadows ③ are formed by objects in the room ② (support columns, separator grids, etc.). The safety laser scanner cannot monitor these areas.

You draw objects that limit the field of view of the safety laser scanner as masked areas.

Table 13: Mask areas

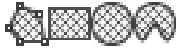
	Mask areas
	Hatched drawing tools

Procedure

1. Click on the **Mask areas** tool.
- ✓ The tools you can use to draw fields are shown crosshatched.
2. Choose a drawing tool.
3. Draw the masked area.

- ✓ The masked area is shown in gray.
- ✓ The field editor shows the shadowing of the masked area.

7.9.8 Defining global geometry

Overview

You draw field geometries and non-monitored areas as global geometry. The global geometry affects all protective fields and warning fields.

Table 14: Defining global field geometry

	Edit field editor settings
---	----------------------------

Procedure

1. Click on the **Edit field editor settings** tool.
2. Activate the **Use global geometry** checkbox.
3. In the **Field set** area, select > **Global Geometry**.
4. Draw a global field geometry.
5. If applicable, draw non-monitored areas with the **Mask areas** tool.

7.9.9 Enable propose field

Overview

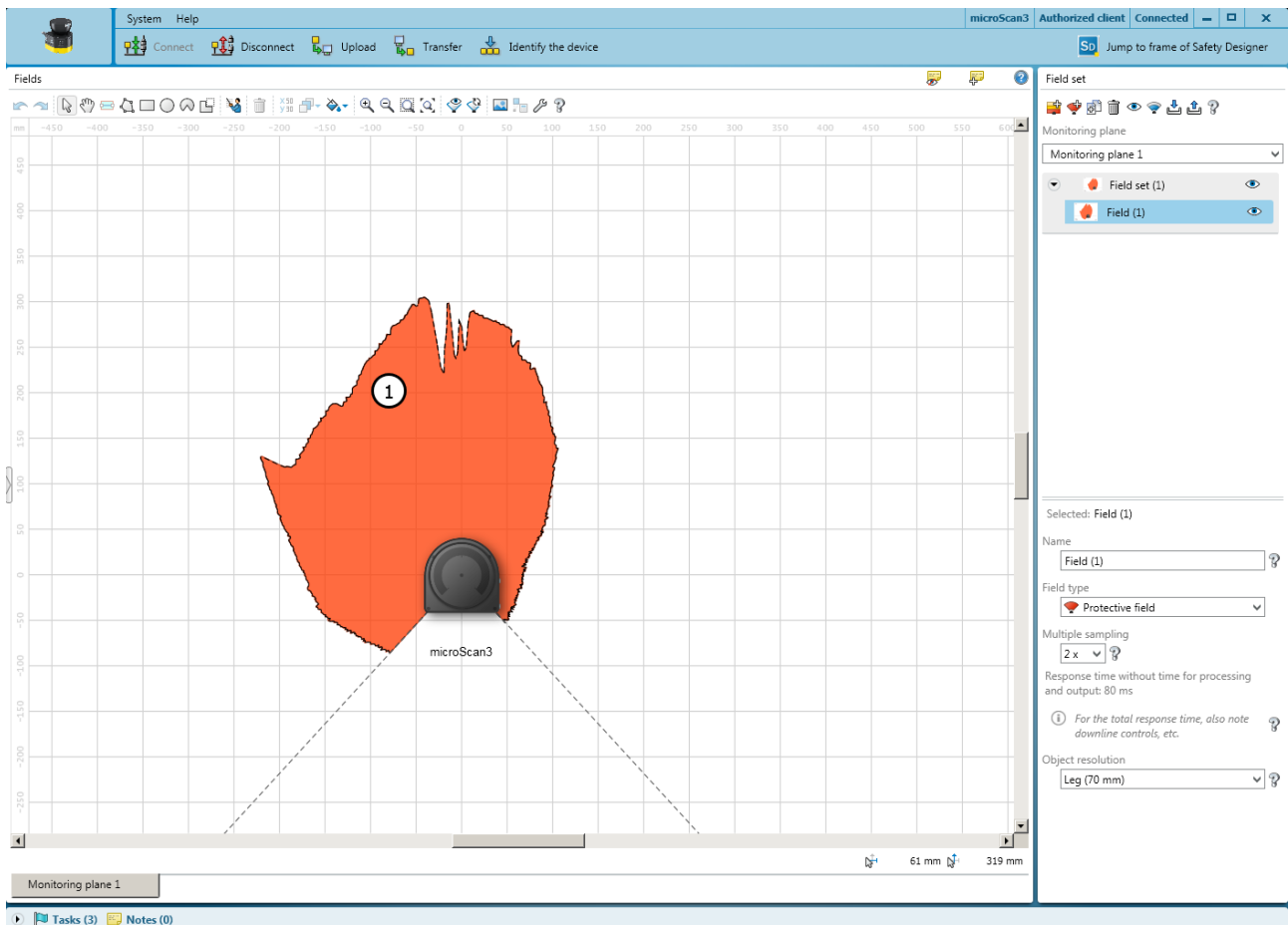

Figure 64: Enable propose field

- ① Proposal for a protective field

You can have a protective field or warning field suggested by Safety Designer.

For this purpose, the safety laser scanner scans the visible surrounding contour several times. Based on the data obtained, the Safety Designer suggests the contour and size of the field.



You can use the **Suggest field** tool to create a field.

Important information



NOTE

If you propose a protective field, the proposal does not replace calculation of the minimum distance. You must calculate the minimum distance and check whether the size of the proposed protective field is sufficient. You must also take into account the measurement tolerances of the safety laser scanner.

Existing field geometries

- **Delete existing shapes:** The field is redrawn according to the surrounding contour.
- **Refine existing shapes:** The existing field is adapted to the surrounding contour.

Measurement method

- **Use every single distance value:** Each scan of the surrounding contour is used individually to draw the field.
- **Use median of distance values:** The median of the last 25 scans is used to draw the field.

Type of teach-in

- **Only allow reduction:** The shortest measured distance is used at each angle. If you walk along the borders of the imaginary field and, e.g., hold a board or cardboard into the laser beam, this restricts the surrounding contour.
- **Allow expansion:** The surrounding contour is used as it is measured.

Automatic reduction

You can specify that the proposed field is drawn smaller than the measured surrounding contour so that the field will be at a distance from walls. The default value corresponds to the TZ value (tolerance zone of the safety laser scanner).

Smoothing by point reduction

The proposed contour may initially be uneven and consist of very many points. With the **Smoothing by point reduction** option, you can reduce the number of points and simplify the lines.

7.10 Inputs and outputs, local

Overview

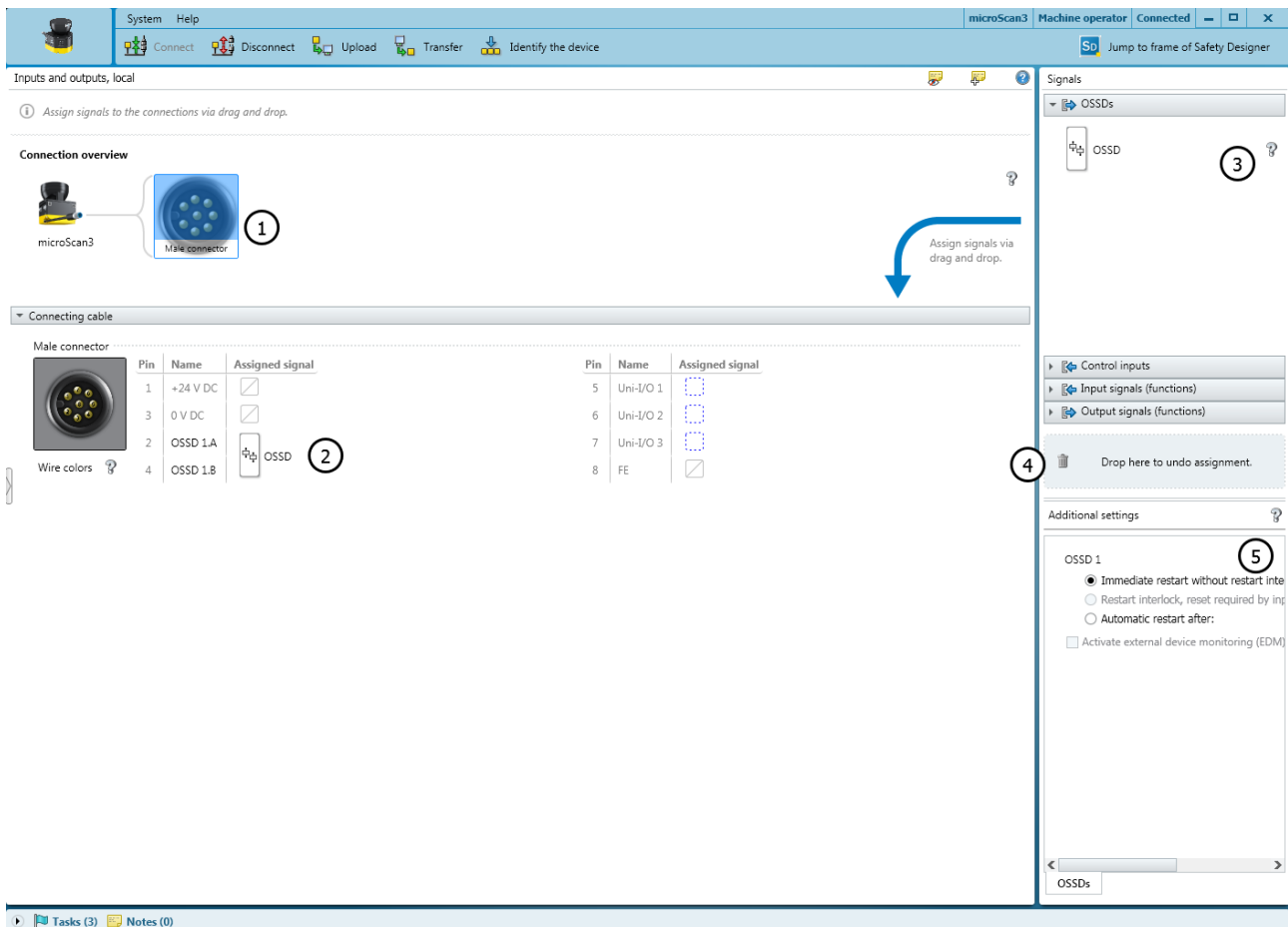

Figure 65: Inputs and outputs, local

- ① Overview: Plug connectors of the safety laser scanner
- ② Pin assignment
- ③ Available signals
- ④ Remove signal from connection
- ⑤ Further settings for some signals

Assign the required signals to the safety laser scanner connection in the **Inputs and outputs, local** dialog box.

Connection overview

Safety Designer shows the plug connector of the safety laser scanner.

Pin assignment

Safety Designer displays the plug connector with its individual pins.

Assigning signals to the pins

Safety Designer shows the available signals on the right under **Signals**.

- ▶ Click on the desired signal type (e.g., on **Inputs**).
- ✓ The menu shows the possible inputs.
- ▶ Drag the signal towards the pins.

- ✓ Possible pins for the connection are highlighted. Safety Designer checks for any restrictions that may apply. For example, an OSSD cannot be placed on an input.
- ▶ Drop the signal on the pin.
- ✓ The signal name is shown on the right next to the pins.

Removing signals

- ▶ Click on the signal.
- ▶ Drag the signal on to the trash-can symbol.
- ✓ The pins are free again.

7.10.1 Outputs

OSSD

OSSD pair.

Contamination

Signals that the optics cover is contaminated.

- **Partial contamination, optical cover should be cleaned soon (contamination warning).** setting: The optics cover needs to be cleaned soon.
- **Switch the safety laser scanner to the OFF state in the event of severe contamination (contamination error).** setting: All safety outputs in the OFF state. The optics cover is severely contaminated and must be cleaned immediately.

Error

Signals an error.

- **Device error** setting: Device errors are serious errors where all safety outputs switch to the OFF state and the device switches to the locking state. Once the cause of the error has been rectified, the device must be completely restarted.
- **Application error** setting: In the event of an application error, all safety outputs switch to the OFF state. Once the cause of the error has been rectified, the safety function must be restarted.

Reset required

Signals that a reset is possible. A connected lamp lights up if the restart interlock has been triggered and the protective field is then clear again.

Monitoring result

Indicates the status of the active field. A connected lamp lights up if an object is detected in the field.

Reset required (flashing)

Signals that a reset is possible. A connected lamp flashes if the restart interlock has been triggered and the protective field is then clear again.

Further topics

- ["Status indicator with the display", page 123](#)

7.10.2 Inputs

Static control input

Signal of the machine controller for switching between monitoring cases.

External device monitoring (EDM)

Signal from the auxiliary contacts of the positively guided contactors for external device monitoring (EDM).

Reset

Signal from the reset pushbutton to manually reset the internal restart interlock.

Sleep mode

Signal from a pushbutton to activate sleep mode.

Restart device

Signal from a pushbutton to completely restart the device.

Pause event recording

Signal of a pushbutton to stop the event history.

Further topics

- ["External device monitoring \(EDM\)", page 61](#)
- ["Restart interlock", page 57](#)
- ["Device restart", page 114](#)

7.10.3 Further settings for some signals

Safety Designer shows the setting options for some signals under **Properties** at the bottom right.



DANGER

Hazard due to lack of effectiveness of the protective device
Hazard due to unexpected starting of the machine

By configuring the restart interlock for an OSSD pair, you can influence the restart interlock behavior for the application.

- ▶ Take account of the notes in the project planning chapter.
-

Restart interlock for the OSSD pair

The safety laser scanner has the following options for the restart interlock behavior for the OSSDs:

- **Immediate restart without restart interlock:** If there is no longer an object in the protective field, the safety laser scanner switches the OSSDs to the ON state.
- **Restart interlock, reset required by input signal:** If the operator activates the restart or reset control switch, the safety laser scanner switches the OSSDs to the ON state.
- **Automatic restart after::** If there is no longer an object in the protective field, the safety laser scanner switches the OSSDs to the ON state after the configured delay.

Activate external device monitoring (EDM)

An input must be configured for external device monitoring (EDM). This input must be correctly connected to the electric control (see ["External device monitoring \(EDM\)", page 61](#)).

If external device monitoring is activated, the safety laser scanner checks whether voltage is applied at the external device monitoring (EDM) input after the OSSDs have been switched off.

If no voltage is applied at the input after the OSSDs have been switched off, the safety laser scanner changes to the locking state and does not switch the OSSDs back to the ON state.

Signal level

For some non-safe output signals, you can select whether the signal is output with HIGH or with LOW:

- **Setting Hi:** The output is normally in LOW state. If the signal is active, the output switches to HIGH state.
- **Setting Lo:** The output is normally in HIGH state. If the signal is active, the output switches to LOW state.

Further topics

- ["Restart interlock", page 57](#)

7.11 Monitoring cases

Overview

Monitoring cases

Create monitoring cases that correspond to the operational states of the machine. Monitoring cases are activated using input signals. Assign the fields that are to be monitored to each monitoring case.
Configure inputs and outputs: [Inputs and outputs, local](#)

Monitoring case table 1 - Monitoring case table 1

Name: Monitoring case table 1

Static control inputs: "Local inputs"

Inputs used: A Input delay: 12 ms

No.	Name	Inpt. cond.	Cut-off path
1	Monitoring ca...	A	Field set (1) Field (1) Field (2)
	Sleep mode		

OSSDs: 1 2 3

Universal outputs: 1 2 3

Field sets

Monitoring plane: Monitoring plane 1

- Field set (1)
 - Field (1)
 - Field (2)

Defined cut-off behavior

- Always OFF
- Always ON (NON-safe)
- Always ON (safe)

Determine the behavior of the cut-off path if no field is assigned (always ON or always OFF).

Drop fields here to delete the assignment.

Figure 66: Monitoring cases

- ① Settings for the whole monitoring case table
- ② Configured field sets
- ③ Settings for the individual monitoring case
- ④ Input conditions for a monitoring case
- ⑤ Field set in the monitoring case and in the cut-off path
- ⑥ Cut-off paths
- ⑦ Areas for defined cut-off behavior
- ⑧ Remove field set from a monitoring case

In the monitoring case editor, you can also define the monitoring cases with input conditions and assign the field sets.

Further topics

- ["Monitoring case", page 20](#)

7.11.1 Settings for monitoring case tables

Name

In the **Name** field, enter a name for the monitoring case table that is as descriptive as possible.

Inputs used

If you want to use static control inputs for monitoring case switching, then select the inputs here.

In antivalent evaluation, the 2 channels of each static control input must always be inverted, even if the status of a control input in a monitoring case is random. If it is not inverted, all safety outputs switch to the OFF state and the device displays an error.

Input delay

If you use static control inputs for monitoring case switching, you can select a delay for the inputs.

If your control device, which you use to switch the static control inputs, cannot switch to the appropriate input condition within 12 ms (for example because of the switch's bounce times), you must configure an input delay. For the input delay, select a time in which your control device can switch in a defined way to a corresponding input condition. You can increase the delay time incrementally.

The following empirical values exist for the switching time using various methods:

Table 15: Empirical values for the required input delay

Switching method	Required input delay
Electronic switching via control, complementary electronic outputs with 0 ms to 12 ms bounce time	12 ms
Tactile controls (relays)	30 ms to 150 ms
Control via independent sensors	130 ms to 480 ms

Also, take account of the notes relating to when to switch between monitoring cases (see "Monitoring case switching time", page 31).

Further topics

- "Static control inputs", page 56

7.11.2 Settings for monitoring cases

Name

Enter a name which is as descriptive as possible for the monitoring case in the **Name** field. If you create a lot of monitoring cases, you should consider a naming concept that makes it possible to identify the monitoring cases easily (for example right cornering, left cornering).

Sleep mode

If you activate this option, the safety laser scanner changes to the sleep mode as soon as the input conditions for this monitoring case exist.

7.11.3 Input condition

For each monitoring case, choose the input conditions for which the monitoring case will be activated.

- ▶ Activate the combination of inputs for each monitoring case.
- ✓ The relevant monitoring case is activated for exactly this combination.
- ✓ Combinations which are invalid or already assigned are marked.

Complementary information

The **Generate input conditions** function allows you to automatically assign input conditions to monitoring cases.

7.11.4 Cut-off paths

You can create cut-off paths and define the outputs switched by the cut-off paths. (Example: the protective fields switch the OSSD pair, the warning fields switch a universal output.)

You need a cut-off path for every field in a field set. If the field sets have different sizes, use the field set with the most fields as a guide.

Creating cut-off path and entering a name

1. Create a cut-off path for every field in the largest field set.
2. Enter a descriptive name for each cut-off path.

Assigning an OSSD pair

- ▶ Place a check in the box for the OSSD pair.
- ✓ The OSSD pair is assigned to the cut-off path.

Assigning unsafe outputs

- ▶ Place a check in the box for the universal output(s).
- ✓ The universal output is assigned to the cut-off path.

7.11.5 Assigning field sets

Overview

The field sets that have been created are listed in the **Field sets** area.

Procedure

Assign a field set to a monitoring case

- ▶ Assign a field set to a monitoring case using drag and drop.
- ✓ The fields in a field set are arranged as they were drawn in the field editor.

Assigning a field to a monitoring case

1. Assign a field set to a monitoring case using drag and drop.
2. Right click on the assigned field set and select **Split fieldset**.
3. Assign the individual fields to one or various monitoring cases.

Removing assignment

- ▶ Drag a field set or field from a monitoring case onto the trash can icon.

7.11.6 Assigning a defined cut-off behavior

Overview

In a monitoring case, you can assign a defined cut-off behavior to a cut-off path instead of a field:

- **Always OFF:** If the monitoring case becomes active, the cut-off path is in the OFF state.
- **Always ON (NON-safe):** If the monitoring case becomes active, a safety output in the cut-off path is always in the OFF state. A non-safety output is always in the ON state.
- **Always ON (safe):** If the monitoring case becomes active, the cut-off path is in the ON state.

Important information



DANGER

Hazard due to lack of effectiveness of the protective device

Persons and parts of the body to be protected may not be recognized in case of non-observance.

The **Always ON (safe)** function has the same effect as a field which is always clear. In a monitoring case with the **Always ON (safe)** function, the cut-off path containing this function is permanently in the ON state.

Procedure

Assigning a defined cut-off behavior

- ▶ Assign a cut-off behavior to a cut-off path in a monitoring case using drag-and-drop.

Complementary information

If you have not assigned fields to certain cells in a monitoring case table, Safety Designer automatically assigns the **Always OFF** function to these cells.

7.11.6.1 Configuring the default settings for defined cut-off behavior

Overview

With this function, you can define specified cut-off behaviors per cut-off path as default settings for monitoring cases.

Table 16: Show/hide preset for specified cutoff behavior

	Show/hide preset for specified cutoff behavior
--	--

Procedure

1. Select **Show/hide preset for specified cutoff behavior**.
 - ✓ Safety Designer displays an additional line in the monitoring case table.
2. Assign a cut-off behavior to a cut-off path in the **Preset for specified cutoff behavior** cell using drag and drop.
 - ✓ Safety Designer applies the default settings when you add a new monitoring case.

7.11.7 Importing and exporting monitoring case tables

Overview

If you need identical monitoring case tables for different projects, you can export entire monitoring case tables out of one project and import them into another project.

Prerequisites

- The inputs used are the same for the target project as for the source project.
- The number of field records and fields created is the same for the target project as for the source project.
- The names of the field sets and fields is the same for the target project as for the source project.

Importing monitoring case tables

1. Click on **Importing from .xml...**
2. Select exported file with monitoring case table.
3. Start the import.
 - ✓ The monitoring case table is imported.

Exporting monitoring case tables

1. Click on **Exporting to .xml....**
2. Select desired folder and enter file name under which the monitoring case table will be saved.
3. Start the export.
- ✓ The monitoring case table is exported.

Complementary information

In many cases, it makes sense to first export the field records from the source project and import them into the target project, see "[Importing and exporting field sets and fields](#)", page 96.

7.12 Simulation

Overview

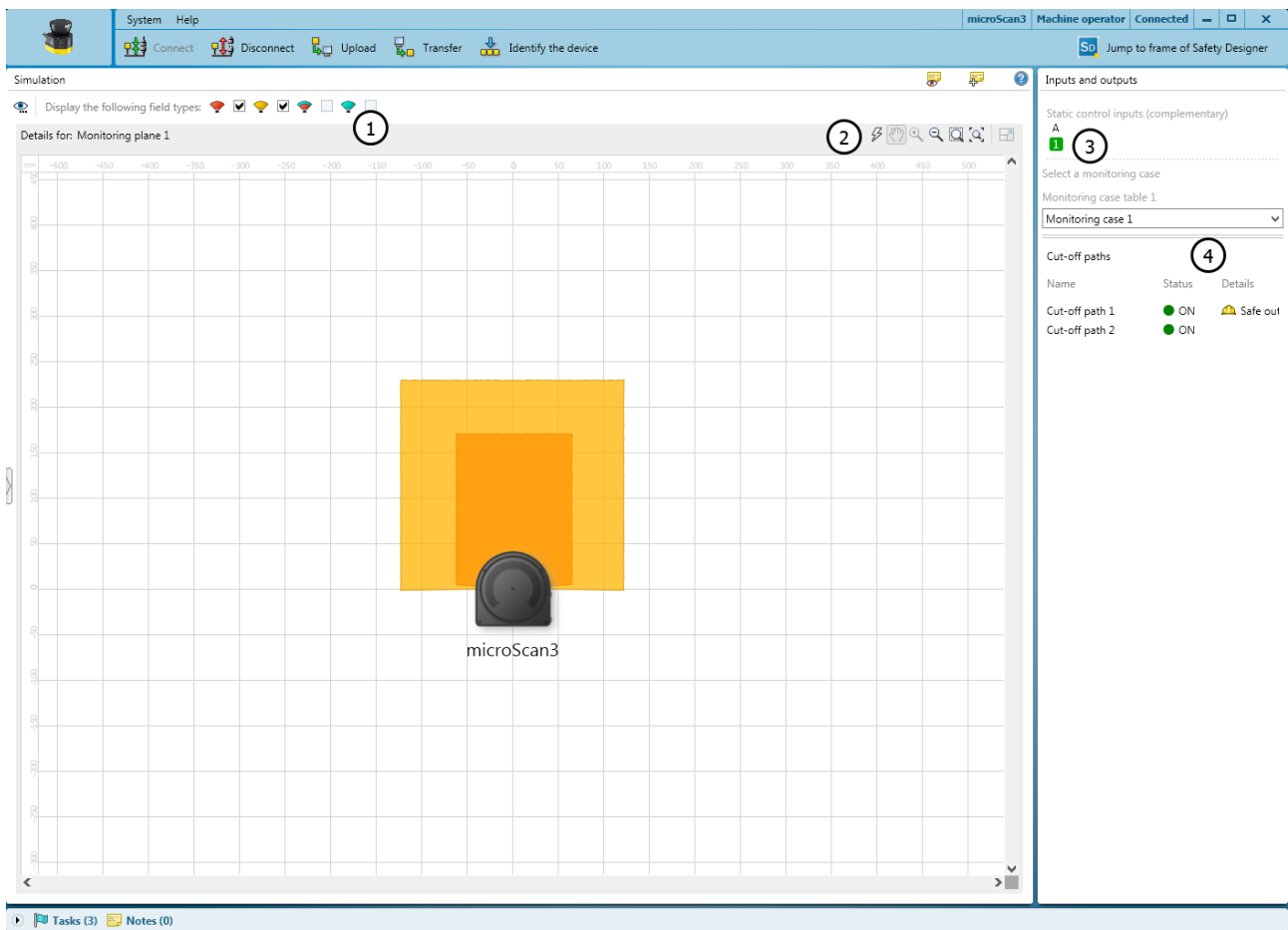

Figure 67: Simulation

- ① Show or hide field types
- ② Simulation tools
- ③ Select input conditions
- ④ Display the cut-off paths

You can visualize the result of the set configuration in the simulation.

Simulation components and options

- Display the status of the OSSD pairs
- Display the status of the cut-off paths
- Get feedback about which monitoring case is active for the selected input sample (default: monitoring case 1 is active)
- You can switch inputs, monitoring cases, etc. virtually using symbols and observe the result
- You can simulate an object detection in a field and check the result.
- You can move fields to the foreground or to the background using the context menu (right mouse button)

7.13 Transfer

Transferring configuration



DANGER

Hazard due to lack of effectiveness of the protective device

Persons and parts of the body to be protected may not be recognized in case of non-observance.

When transferring the configuration, the protective device's existing configuration may be overwritten.

- ▶ Check the configuration carefully before transfer.
- ▶ Make sure that the desired device is connected during transfer.

At first, the configuration only exists as a project, namely as a configuration file. The configuration must be transmitted to the device.

At the left, you see the values configured in the project for the device. If the device is connected, you see the values saved in the device at the right.

The compatibility of the configuration is checked during transfer.

Checking the configuration



DANGER

Hazard due to lack of effectiveness of the protective device

Persons and parts of the body to be protected may not be recognized in case of non-observance.

If the configuration is verified, the device automatically starts the safety function after switching on the voltage supply.

If the configuration is not verified, the safety laser scanner may not be operated as a protective device. You can start the safety function manually to test the safety laser scanner and the configuration. The test operation has a time limit.

- ▶ Only operate the safety laser scanner as a protective device if the configuration is verified.

You can start the safety function manually to test the safety laser scanner with the new configuration, see "[Starting and stopping safety function](#)", page 112.

Verifying configuration



DANGER

Hazard due to lack of effectiveness of the protective device

Persons and parts of the body to be protected may not be recognized in case of non-observance.

By verifying the configuration, you can confirm that the configuration complies with the planned safety function and fulfills the requirements in the risk assessment.

- ▶ Check the verification report carefully before confirming verification.
- ▶ If the configuration deviates from the planned safety function or does not fulfill the requirements in the risk assessment, verification must not be confirmed.

The configuration must be verified to ensure that the safety function is implemented correctly.

During verification, Safety Designer reads back the transmitted configuration from the safety laser scanner. It compares the configuration with the configuration saved in Safety Designer. If both configurations are identical, Safety Designer displays the verification report. If the user confirms that this is correct, the system is considered to be verified.

Transmitting and verifying the configuration of an individual safety laser scanner

1. Click on **Identify the device** to ensure that the desired device is connected.
 - ✓ The display of the connected device flashes blue.
2. If the checksums on the PC and device differ, click on **Transfer to device**.
 - ✓ The transfer process is shown in Safety Designer and on the device.
 - ✓ Safety Designer will notify you as soon as the transfer process is complete.
3. Next click on **Verify**.
 - ✓ Safety Designer displays the verification report.
4. Check the verification report and, if necessary, click on **OK**.
 - ✓ Device configuration is shown as verified.

7.14 Starting and stopping safety function

In some situations, it is possible to start or stop the safety function manually.

Table 17: Starting and stopping safety function



Start

starts the safety function.



Stop

stops the safety function.



DANGER

Hazard due to lack of effectiveness of the protective device

Persons and parts of the body to be protected may not be recognized in case of non-observance.

If the configuration is verified, the device automatically starts the safety function after switching on the voltage supply.

If the configuration is not verified, the safety laser scanner may not be operated as a protective device. You can start the safety function manually to test the safety laser scanner and the configuration. The test operation has a time limit.

- ▶ Only operate the safety laser scanner as a protective device if the configuration is verified.

7.15 Reports

Overview

Report

System Help microScan3 Machine operator Connected Jump to frame of Safety Designer

Connect Disconnect Upload Transfer Identify the device Stop

1. PROJECT INFORMATION

Date of generation: 4/6/2018 9:57:46 AM
 Safety Designer version: SAFETY DESIGNER ENGINEERING TOOL 0.0.0.1357 - -SNAPSHOT 0.0.0.1357
 Project name:
 User name:
 Project description:
 Culture: en-US, English (USA), Date: First of May, two thousand and ten: 5/1/2010, Time: A quarter past one and thirtythree seconds (PM): 1:15:33 PM, One million: 1,000,000.00.

2. OVERVIEW

User group	Machine operator
Username	
Projektname	
Application name	
Application description	
Device name	microScan3
Device type	microScan3 Pro - EtherNet/IP, 4m
Vendor ID	808
Device type	101
Type key	10770
Major Revision	1
Minor Revision	2

check sum	in the project file	in the device
Checksum of the configuration (function and network)	0xC115809F	0xC115809F
Checksum of the configuration (function)	0xAAC99DCF	0xAAC99DCF
Lower-level identification number of the checksums	0xD8481156178A5DA634BAC2FD035AD60F	0xD8481156178A5DA634BAC2FD035AD60F

Configuration status	Verified
Verification data	4/4/2018 12:03:24 PM
Configuration date	4/4/2018 12:02:33 PM

3. TASKS AND NOTES

3.1 Tasks

Tasks (1) Notes (0)

Settings for reports

Subareas

- Project information
- General configuration
- Open ToDos and User notes
- Bill of materials
- Network
- Configuration
- Status
- Diagnostics

Figure 68: Report

- ① Contents of the report
- ② Composition of the report

A report shows the settings and data of a device. You have the option of saving and archiving these data as a PDF.

Report

When you open the **Report** dialog box, the Safety Designer creates a report. If you click on **Update** after making changes to the configuration, you will receive an updated report.

Compiling a report

You compose the contents of a report individually:

1. Select the contents of the report under **Settings for reports**.
- ✓ Safety Designer creates a report with the selected contents.

Complementary information

National and international standards promote or recommend specific data and the person responsible for it. The required data are included in the report.

1. Print the report.
2. Write down the responsible person on the report.
3. Archive the report.

7.16 Service

7.16.1 Device restart

If you have problems with the device, you can restart the device or subsections of the device (safety function, connections, additional functions).

Restarting safety function

- The fastest type of restart
- Serious errors remain, even if the cause has been rectified (for example a locking state because of a supply voltage which is too low).
- Communication with the device remains intact (connections for configuration, safety function and data not relating to safety).
- Communication beyond the device is not impaired.

Restarting safety function and connections

- The device's function is also re-established after serious errors if the cause has been rectified.
- Communication with the device is interrupted (connections for configuration, safety function and data not relating to safety). The device sets up communication again automatically after restarting.
- Communication beyond the device is not impaired.

Restarting device completely

- The device behaves exactly as it does when the voltage supply is switched off and back on again.
- The device's function is also re-established after serious errors if the cause has been rectified.
- Communication with the device is interrupted (connections for configuration, safety function and data not relating to safety).
- Communication beyond the device is interrupted. This may also affect devices which communicate beyond the device.

7.16.2 Factory settings

Overview

Before reconfiguring the device, you can reset all settings to factory settings.

Depending on the device, 2 or 3 options are available.

Devices with 2 options for resetting to factory settings

Resetting safety function to factory settings

- The configuration for the safety function is reset to factory settings.
- Communication beyond the device is not impaired.

Resetting complete settings to factory settings

- The configuration for the safety function is reset to factory settings.
- The configuration of device communication is reset to factory settings (connections for configuration, safety function and data not relating to safety).

Devices with 3 options for resetting to factory settings

Resetting safety function to factory settings

- The configuration for the safety function is reset to factory settings.
- Communication beyond the device is not impaired.

Resetting safety function and communication settings to factory settings

- The configuration for the safety function is reset to factory settings.
- The configuration of device communication is reset to factory settings (connections for configuration, safety function and data not relating to safety).

Resetting complete settings to factory settings

- The configuration for the safety function is reset to factory settings.
- The configuration of device communication is reset to factory settings (connections for configuration, safety function and data not relating to safety).
- The **Maintenance personnel** and **Authorized client** user groups are deactivated.
- The password of the **Administrator** user group is reset to the factory settings.

7.16.3 Managing passwords**Assigning or changing passwords**

1. Establish a connection to the device.
 2. In the device window under **Service**, select the **User password** entry.
 3. In the **User password** dialog, select the user group.
 4. Enter the new password twice and confirm with **Transfer to device**.
 5. When you are prompted to log on, select your user group and enter the corresponding password.
- ✓ The new password is valid for the user group immediately.

Resetting a password

If you have forgotten the password of the privileged user group, you can reset it.

For devices with 3 user groups, user group **Authorized client** is the privileged user group. For devices with new rights management (4 user groups, newer range of functions), user group **Administrator** is the privileged user group.

Reset user group password Authorized client:

1. Request the form for resetting your password from SICK support.
 2. Connect to the device in Safety Designer.
 3. In the device window under **Service**, select the **User password** entry.
 4. In the **User password** dialog, select the **Reset Password** option.
 5. Transmit the serial number shown and the device counter together with the product number and the type code on the form to SICK support.
- ✓ You will then receive a reset code.
6. Enter the reset key under **Reset Password** and confirm with **Apply**.
- ✓ The passwords are reset to factory settings (SICKSAFE for **Authorized client**, no password for **Operator**, no login possible for **Maintenance personnel**). The configuration is not changed.

Reset user group password Administrator:

1. Request the form for resetting your password from SICK support.
 2. Connect to the device in Safety Designer.
 3. In the device window under **Service**, select the **User password** entry.
 4. In the **User password** dialog, select the **Start process for resetting the password** option.
 5. Send the information displayed on the form to SICK support.
- ✓ You will then receive an activation code.
6. Enter and confirm the activation code in the field provided in Safety Designer.
- ✓ The password of the **Administrator** user group is reset to factory settings (SICKSAFE). The **Maintenance personnel** and **Authorized client** user groups are deactivated. The configuration is not changed.

Further topics

- ["Version numbers and functional scope", page 143](#)

7.16.4 Access management

Overview

You can activate or deactivate interfaces and selected functions as needed.

In the **Projected device** area, you can see the settings in the project.

When a device is connected, you can see in the **Physical device** area the configuration in the device and the status describing the actual behavior of the device.

Older devices may not support all settings.

Functions and settings

You can activate, deactivate or select the default setting for each function displayed. The default setting depends on the device and its range of functions.

Safety Designer displays the minimum functionality that the device must have to support the setting.

Behavior if the "deactivated" setting is not supported by the device or replacement device:

It may happen that settings are stored in the system connector that the device cannot evaluate, e.g. because a device has been replaced by an older device. You can set how the device should behave in this case.

Older devices ignore all settings in this window. Safety Designer shows up to which functional range the settings are ignored.

7.16.4.1 Functions and settings

Device restart (without network) via device display

You can specify whether the device can be restarted using the pushbuttons on the display.

7.16.5 Optics cover calibration

Overview

After replacing an optics cover, the measurement system of the safety laser scanner must be calibrated to the new optics cover. During optics cover calibration, the reference for the contamination measurement of the optics cover is defined (status = not contaminated).

Important information



WARNING

Incorrect reference value of optical properties

If optics cover calibration is not done correctly, persons and parts of the body to be protected may not be detected.

- ▶ Carry out an optics cover calibration with the Safety Designer every time the optics cover is replaced.
 - ▶ Carry out the optics cover calibration at room temperature (10 °C to 30 °C).
 - ▶ Only carry out the optics cover calibration using a new optics cover.
 - ▶ Before the optics cover calibration switch on the device for a few minutes to warm up the internal components.
 - ▶ Make sure that the entire system is clear of contamination when the adjustment is carried out.
-

Procedure

1. Before the optics cover calibration, switch on the device for a few minutes to warm up the internal components.
2. In the **Exchange** column, click on **Yes**.
3. Check that the optics cover is clean.
4. In the **Check cleanliness** column, click on **OK**.
5. In the **Optical cover calibration** column, click on **Start**.
- ✓ The calibration process starts. Typically, this process can take up to a minute. A progress bar shows the progress.
6. Do not switch off the safety laser scanner and do not disrupt the connection between the computer and the safety laser scanner during the adjustment.
- ✓ The end of the calibration is shown.

7.16.6 Compare configuration

Overview

You can use this function to compare the current configuration in the device window with a previously exported configuration or the configuration in the device.

Exported configurations are stored in their own format: “.sdsc”. You can export a configuration under **Service > Compare configurations** in the **Current configuration of project** area in the device window.

Prerequisites

- The configuration export contains only one device.
- Type code of the device is identical in both configurations.
- Version number of the functionality is identical in both configurations.





Procedure

1. In the navigation menu of the device window, navigate to **Service > Compare configurations**.
- ✓ The Safety Designer shows the current device configuration at the top left of the workspace.
2. Reading in comparison data:
 - Reading a configuration from the device: Open the drop-down menu next to the device symbol and select **Read from Device**.
 - Importing a configuration file: Select and import a previously exported configuration file using **Import data**.
 - Use the current configuration in the device window: Select **Use comparison data**.
- ✓ The Safety Designer starts the configuration comparison and displays the results in a table in the workspace.
3. If necessary, export the comparison result as a .csv file using **Export result** via the comparison table.

Complementary information

Table 18: Buttons

Button	Description
	Current configuration of project area: Exports the current configuration in the “.sdsc” format for another comparison
	Comparison data area: Exports the comparison configuration in the “.sdsc” format
	Via the comparison table: Exports the comparison result

Button	Description
	Imports the configuration file in the “.sdsc” format
	Identifying the device
	Reads the configuration from the device
	Updates the configuration comparison

8 Commissioning

8.1 Safety

**WARNING**

Hazard due to lack of effectiveness of the protective device

- ▶ Before commissioning the machine, make sure that the machine is first checked and released by qualified safety personnel.
- ▶ Only operate the machine with a perfectly functioning protective device.

**DANGER**

Dangerous state of the machine

During commissioning, the machine or the protective device may not yet behave as you have planned.

- ▶ Make sure that there is no-one in the hazardous area during commissioning.

**DANGER**

Hazard due to lack of effectiveness of the protective device

When changes are made to the machine, the effectiveness of the protective device may be affected unintentionally.

- ▶ After every change to the machine and changes to the integration or operational and secondary conditions of the safety laser scanner, check the protective device for effectiveness and recommission as specified in this section.

Before initial commissioning, project planning, mounting, electrical installation and configuration must be completed in accordance with the following chapters:

- ["Project planning", page 24](#)
- ["Mounting", page 66](#)
- ["Electrical installation", page 69](#)
- ["Configuration", page 72](#)

8.2 Alignment

The following options are available to you for precisely aligning the safety laser scanner using mounting kit 2:

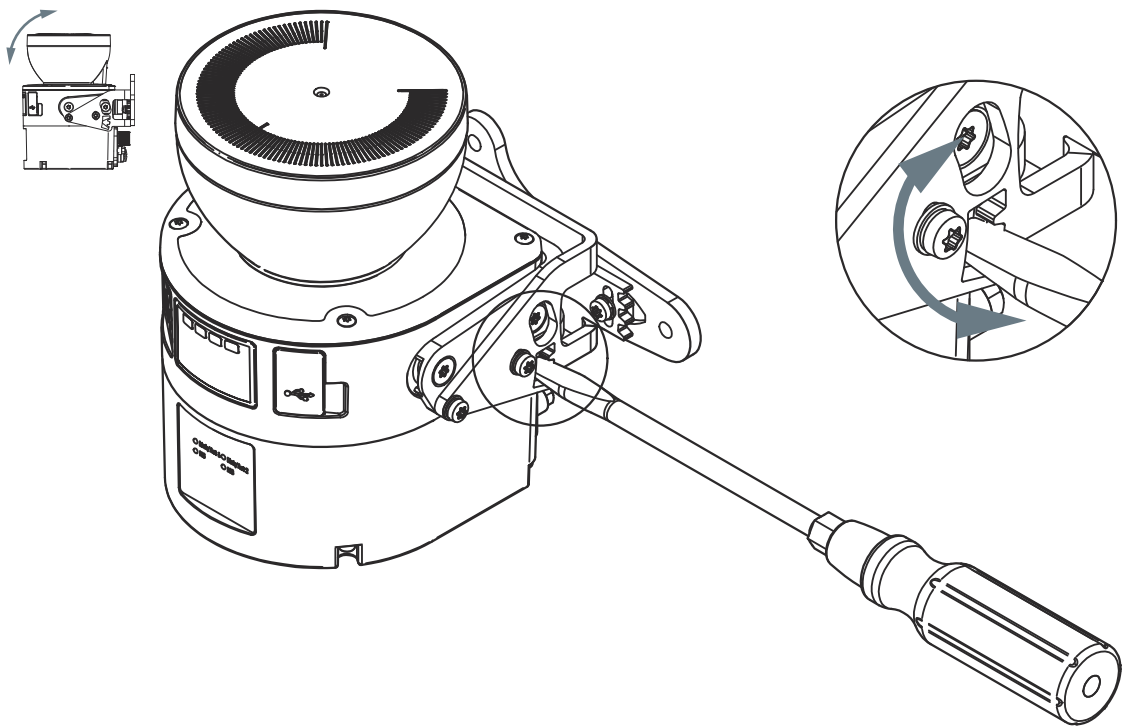

Figure 69: Alignment about the transverse axis

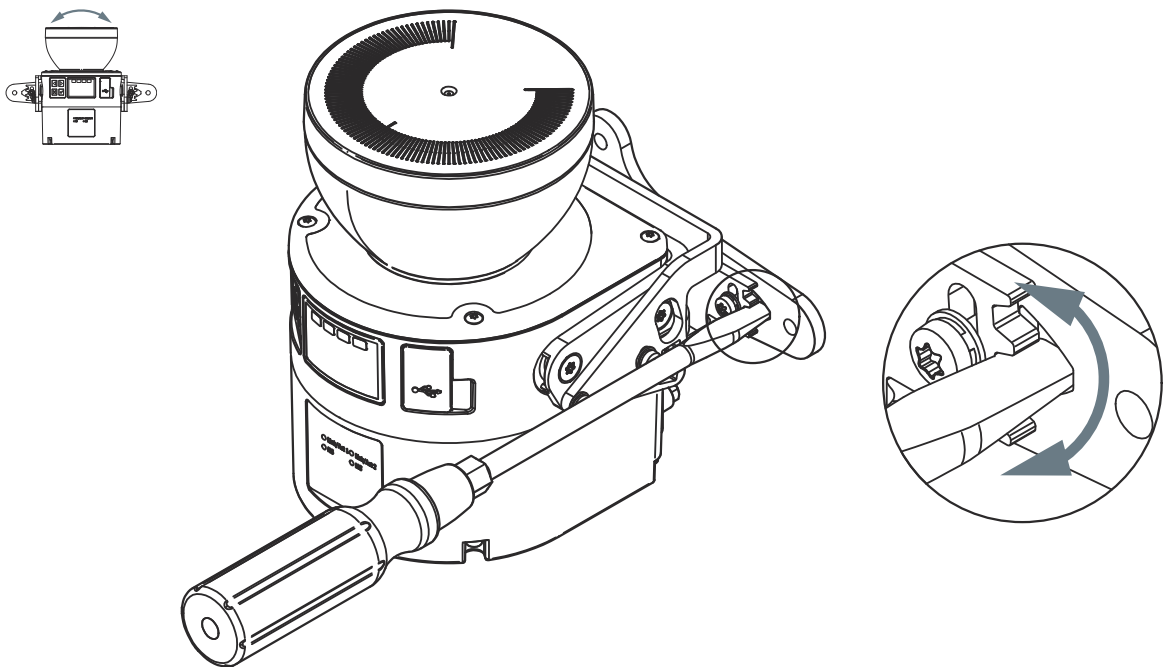

Figure 70: Alignment about the depth axis

- ▶ After alignment, tighten the screws with the specified tightening torque.

8.3 Switching on

After switching on, the device performs various internal tests. The OFF LED illuminates continually. The ON LED is off.

The start procedure lasts approx. 10 seconds.

When the startup process is finished, the status LEDs and the display show the current operational status.

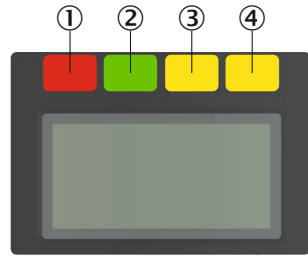

Figure 71: Status LEDs

Table 19: Status LEDs

Number	Function	Color	Meaning
①	OFF state	Red	Lights up red when the OSSD pair is in the OFF state.
②	ON state	Green	Lights up green when the OSSD pair is in the ON state.
③	Warning field	Yellow	Lights up yellow if an object is detected in at least one warning field.
④	Restart interlock	Yellow	Setup with reset: Flashes if the restart interlock has been triggered. Configuration with automated restart after a time: Lights up while the configured time to restart expires.

The OFF state and ON state light emitting diodes can be found in multiple locations on the device. 3 additional sets are arranged in pairs on the base of the optics cover. So the LEDs can also be seen in many cases when it is not possible to see the display, e.g. due to the mounting situation or because it is hidden from the operator's position.

More information about what the LEDs mean and the symbols and information shown on the display: see ["Troubleshooting"](#), page 133.

8.4 Check during commissioning and modifications

The thorough check is intended to ensure that the safety functions are fulfilling their planned purpose and whether persons are being adequately protected.

- ▶ Carry out the checks specified in the test plan of the manufacturer of the machine and the operating entity.

9 Operation

9.1 Safety



DANGER

Hazard due to lack of effectiveness of the protective device

Persons and parts of the body to be protected may not be recognized in case of non-observance.

- ▶ Maintenance work, alignment work, error analyses, and any changes to the integration of the protective device in the machine must only be carried out by qualified personnel.
- ▶ The effectiveness of the protective device must be checked following such work.



NOTE

This document does not provide instructions for operating the machine in which the safety laser scanner is integrated.

9.2 Regular thorough check

The thorough check is intended to ensure that the safety functions are fulfilling their planned purpose and whether persons are being adequately protected.

- ▶ Carry out the checks specified in the test plan of the manufacturer of the machine and the operating entity.

9.3 Status indicators

Overview



Figure 72: LEDs

- ① Status LEDs
- ② Additional LEDs for ON state and OFF state
- ③ Display

Further topics

- ["Detailed diagnostics using the display", page 133](#)
- ["Error indication on the display", page 135](#)

9.3.1 Status LEDs

4 status LEDs are located directly above the display.

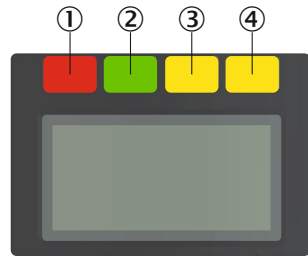

Figure 73: Status LEDs

Table 20: Status LEDs

Number	Function	Color	Meaning
①	OFF state	Red	Lights up red when the OSSD pair is in the OFF state.
②	ON state	Green	Lights up green when the OSSD pair is in the ON state.
③	Warning field	Yellow	Lights up yellow if an object is detected in at least one warning field.
④	Restart interlock	Yellow	Setup with reset: Flashes if the restart interlock has been triggered. Configuration with automated restart after a time: Lights up while the configured time to restart expires.



The OFF state and ON state light emitting diodes can be found in multiple locations on the device. 3 additional sets are arranged in pairs on the base of the optics cover. So the LEDs can also be seen in many cases when it is not possible to see the display, e.g. due to the mounting situation or because it is hidden from the operator's position.









9.3.2 Status indicator with the display





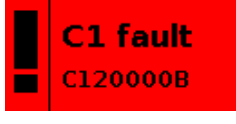

The display shows current information about the status of the safety laser scanner. The display switches off after approx. 60 s if all fields are clear and no other notification is displayed.

- ▶ If the display is switched off, press any pushbutton to activate the display.
- ▶ Press any pushbutton to obtain more details about the displayed status information.
- ▶ If there are a number of pages with detailed information, this is shown in the top right of the display.
- ▶ Press the arrow buttons to change between a number of pages with detailed information.

Table 21: Overview of status information

Display	Device or configuration	Meaning
	All devices and configurations	All fields clear, OSSD pair in ON state. The number at bottom right indicates the active monitoring case.
	Devices with an OSSD pair	OSSD pair in OFF state.

Display	Device or configuration	Meaning
	Configuration with restart interlock	Protective field is clear, reset can take place.
	Configuration with restart interlock	Reset button pressed Safety output in the OFF state.
	Configuration with restart interlock	Reset button pressed Safety output in the ON state.
	Configuration with automated restart after a time	Protective field is clear, configured time to restart expires.
	Configuration with at least one warning field	Detection in the warning field (left column: number of warning fields with detection, right column: number of warning fields in the current monitoring case).
 Display flashes	All devices and configurations	Error. All safety outputs in the OFF state. Additional information: see "Error indication on the display", page 135.
 Display flashes	All devices and configurations	Contamination warning. Check the optics cover for damage. Clean the optics cover.
 Display flashes	All devices and configurations	Contamination error. All safety outputs in the OFF state. Check the optics cover for damage. Clean the optics cover.
 Display flashes	All devices and configurations	Dazzle warning. Check whether the safety laser scanner is being dazzled by an external light source in the scan plane, e.g., sun, halogen light, infrared light source. Remove or cover the light source.
 Display flashes	All devices and configurations	Dazzle error. The associated safety outputs are in the OFF state. Check whether the safety laser scanner is being dazzled by an external light source in the scan plane, e.g., sun, halogen light, infrared light source. Remove or cover the light source.

Display	Device or configuration	Meaning
 Display flashes	Configuration with external device monitoring (EDM)	Error in the external device monitoring (EDM). OSSD pair in OFF state.
 Display flashes	Configuration with reference contour field	Tamper protection. The safety laser scanner does not detect any contour within the configured tolerance band of the reference contour field. All safety outputs in the OFF state.
 Display flashes	All devices and configurations	Tamper protection. The safety laser scanner measures no values within the distance measurement range in an area of at least 90°. All safety outputs in the OFF state.
 Application stopped	All devices and configurations	Safety function stopped. All safety outputs in the OFF state. Restart the device using the keypad or Safety Designer.
 Waiting for inputs	All devices and configurations	A valid input signal is not yet applied at the control inputs. All safety outputs in the OFF state. After switching on, the safety laser scanner waits for a valid input signal. During this time, an invalid input signal does not result in a error.
 No Configuration!	All devices	The device is not configured. The device is in the as-delivered state or has been reset to factory settings. All safety outputs in the OFF state.
 Sleep mode	All devices and configurations	Sleep mode. All safety outputs in the OFF state. Press any pushbutton to obtain more information.

10 Maintenance

10.1 Safety



DANGER

Improper work on the product

A modified product may not offer the expected protection if it is integrated incorrectly.

- ▶ Apart from the procedures described in this document, do not repair, open, manipulate or otherwise modify the product.
-

10.2 Regular cleaning

Overview

Depending on the ambient conditions, the optics cover must be cleaned regularly and in the event of contamination. For example, static charges can cause dust particles to be attracted to the optics cover.

Important information



DANGER

Hazard due to lack of effectiveness of the protective device

Persons and parts of the body to be protected may not be recognized in case of non-observance.

- ▶ Regularly check the degree of contamination on all components based on the application conditions.
-



DANGER

Hazard due to lack of effectiveness of the protective device

Persons and parts of the body to be protected may not be recognized in case of non-observance.

- ▶ Make sure that the optical properties of the optics cover are not changed by:
 - beading water, mist, frost, or ice formation. If necessary, remove any residues of this type or any other form of contamination and restart the safety laser scanner.
 - Damage. Replace damaged optics covers.
 - Substances containing oil or fat. Substances like this may impair the detection capability of the safety laser scanner. Therefore keep the optics cover free from substances containing oil or fat.
-



DANGER

Hazard due to unexpected starting of the machine

- ▶ Make sure that the dangerous state of the machine is and remains switched off during cleaning.
 - ▶ Make sure that the safety laser scanner's outputs do not affect the machine during cleaning.
-



NOTICE

- ▶ Do not use aggressive or abrasive cleaning agents.
 - ▶ Recommendation: Use anti-static cleaning agents.
 - ▶ Recommendation: Use anti-static plastic cleaners and lens cloths from SICK.
-

Procedure**Cleaning the optics cover**

1. Remove dust from the optics cover using a soft, clean brush.
2. Moisten a clean, soft towel with anti-static plastic cleaner and use it to wipe the optics cover.
3. Check the effectiveness of the protective device, see ["Thorough check of the principal function of the protective device", page 63](#).

Complementary information**NOTE**

The display shows a contamination warning if the optics cover is contaminated and needs to be cleaned soon. If it is not cleaned and the contamination continues to increase, the safety laser scanner switches to the OFF state for safety reasons and the display shows a contamination error.

- ▶ Check the optics cover for damage.
- ▶ Clean the optics cover in a timely manner.

Further topics

- ["Spare parts", page 159](#)

10.3 Replacing the optics cover

If the optics cover is scratched or damaged, it must be replaced.

You can order the replacement optics cover from SICK (see ["Spare parts", page 159](#)).

Important information**WARNING**

Incorrect reference value of optical properties

If optics cover calibration is not done correctly, persons and parts of the body to be protected may not be detected.

- ▶ Carry out an optics cover calibration with the Safety Designer every time the optics cover is replaced.
- ▶ Carry out the optics cover calibration at room temperature (10 °C to 30 °C).
- ▶ Only carry out the optics cover calibration using a new optics cover.
- ▶ Before the optics cover calibration switch on the device for a few minutes to warm up the internal components.
- ▶ Make sure that the entire system is clear of contamination when the adjustment is carried out.

**NOTICE**

- ▶ The optics cover of the safety laser scanner is an optical component. Make sure that the optics cover does not become dirty or scratched during unpacking and mounting. Prevent fingerprints on the optics cover. Wear the gloves supplied with the new optics cover during replacement.
- ▶ Replace the optics cover in an environment free of dust and dirt.
- ▶ Never replace the optics cover during continuous operation, as dust particles could penetrate into the safety laser scanner.
- ▶ Avoid soiling the inside of the optics cover, e.g. by fingerprints.
- ▶ Do not use any additional sealant, such as silicone, for sealing the optics cover. Any vapors that are created may damage the optical components.
- ▶ Mount the optics cover according to the following instructions to ensure IP65 leak tightness of the housing.
- ▶ Only use a new optics cover as a replacement.
- ▶ Provide ESD protection when replacing the optics cover.

**NOTICE**

Enclosure rating IP65 only applies if the safety laser scanner is closed and the system plug is mounted.

Replace the optics cover as follows:**Tool required:**

- TX10 torque wrench

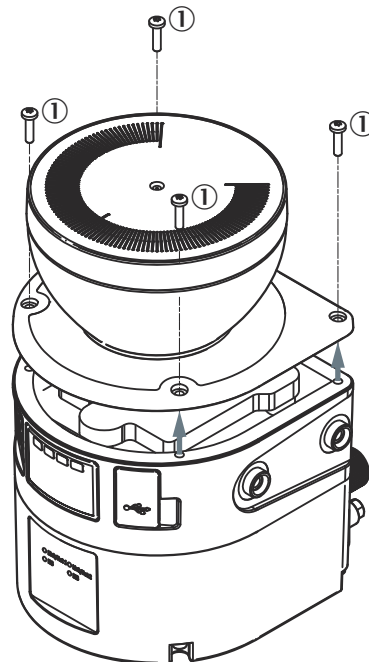

Figure 74: Fixing screws for the optics cover

- ① Fixing screw

1. Make sure that the environment is clean and clear of fog, moisture, and dust.
2. First clean the safety laser scanner from the outside, so that no foreign bodies penetrate into the open device.
3. Unscrew the fixing screws for the optics cover.
4. Slowly and carefully detach the optics cover from the safety laser scanner. If the seal of the optics cover sticks to the safety laser scanner, carefully detach the optics cover using a screwdriver.

5. If necessary, remove contamination from the sealing groove and the bearing surface of the safety laser scanner. Use residue-free plastic cleaners.
6. Check whether the mirror is contaminated. Remove any contamination with an optic brush.
7. If you cannot remove the contamination with the optic brush, contact your local SICK subsidiary.
8. Set 1.0 Nm ... 1.2 Nm tightening torque on the torque wrench.
9. During the following steps, wear the gloves supplied with the new optics cover.
10. Take the new optics cover out of the packaging and remove the seal's protective cap.
11. Remove any packaging residue if necessary.
12. Carefully push the optics cover over the mirror. Make sure that the optics cover does not touch the mirror.
13. Place the optics cover onto the safety laser scanner. Make sure that the optics cover rests over the whole area without any gaps.
14. Screw in new fixing screws, [see figure 74, page 128](#).
15. Tighten the screws using the set tightening torque.
16. Make sure that the optics cover is clear of dirt and damage.

How to recommission the safety laser scanner

1. Properly remount the safety laser scanner, [see "Mounting", page 66](#).
2. Reconnect all electrical connections to the safety laser scanner.
3. Carry out the optics cover calibration, [see "Optics cover calibration", page 116](#).
4. Start the safety function using Safety Designer, [see "Starting and stopping safety function", page 112](#).
5. Check the effectiveness of the protective device.
 - Generally, the protective device is checked exactly as during commissioning, [see "Check during commissioning and modifications", page 121](#).
 - If, during project planning, the possible tolerances of the devices have been considered and it is ensured that neither the configuration nor the wiring or the alignment of the safety laser scanner have been changed, a function test is sufficient, [see "Thorough check of the principal function of the protective device", page 63](#).

10.4 Replacing the safety laser scanner

If the safety laser scanner is damaged or defective, you must replace it.



DANGER

Hazard due to lack of effectiveness of the protective device

If an unsuitable configuration is saved in the system plug, it may cause the dangerous state to not end in time.

- ▶ After replacement, make sure the same system plug is used or the configuration is restored.
- ▶ Make sure that the safety laser scanner is aligned correctly after the replacement.



NOTICE

Enclosure rating IP65 only applies if the safety laser scanner is closed and the system plug is mounted.

**NOTICE**

If the system plug is mounted with excessive force, the contacts can break or bend.

- ▶ Plug in the system plug carefully.
- ▶ Do not force it.

Tool required:

- TX10 Torx wrench
- TX20 Torx wrench

10.4.1 Replacing the safety laser scanner without system plug

Overview

In many cases, you can reuse the existing bracket and the existing system plug. Detach the defective safety laser scanner from the bracket and the system plug. Then, mount the new safety laser scanner on the bracket and the system plug. When the new safety laser scanner is switched on for the first time, it reads the configuration from the system plug and can be used without having to be reconfigured.

Procedure

1. Make sure that the environment is clean and clear of fog, moisture, and dust.
2. Unscrew screws in the system plug and remove the system plug from the defective safety laser scanner.
3. Unscrew the fixing screws and remove the defective safety laser scanner.
4. Mount the system plug on the new safety laser scanner, [see "Replacing the system plug", page 131](#).
5. Mount the new safety laser scanner, [see "Mounting", page 66](#).
6. Check the effectiveness of the protective device.
 - Generally, the protective device is checked exactly as during commissioning, [see "Check during commissioning and modifications", page 121](#).
 - If, during project planning, the possible tolerances of the devices have been considered and it is ensured that neither the configuration nor the wiring or the alignment of the safety laser scanner have been changed, a function test is sufficient, [see "Thorough check of the principal function of the protective device", page 63](#).

Complementary information

In certain cases, you can no longer log into the device with Safety Designer after device exchange.⁶⁾ If you would like to log into the device, e.g. to change the configuration, you have to reset the password with help from SICK. The device works with the existing configuration even without changing the password.

In certain cases (in the event of dust, high air humidity), it may make sense not to disconnect the system plug and the safety laser scanner at first. In these cases, proceed as follows:

1. Disconnect the connecting cables to the system plug.
2. Unscrew screws from the bracket and remove the defective safety laser scanner from the bracket.
3. Move the safety laser scanner with the system plug to a clean location (e.g., office, maintenance areas).
4. Unscrew screws in the system plug and remove the system plug from the defective safety laser scanner.
5. See above for further steps.

⁶⁾ This case can only occur if you replace a device with old rights management with a device with new rights management or vice versa. Devices with newer functional scope use the new rights management.

Further topics

- ["Managing passwords", page 115](#)
- ["Version numbers and functional scope", page 143](#)

10.4.2 Replacing the safety laser scanner completely



1. Disconnect the connecting cables the system plug.
2. Unscrew the fixing screws and remove the defective safety laser scanner.
3. Mount the new safety laser scanner, [see "Mounting", page 66](#).
4. Reconnect the connecting cables to the system plug.
5. Configure the safety laser scanner, [see "Configuration", page 72](#).
6. Perform commissioning again, taking particular care to conduct all of the thorough checks described, [see "Commissioning", page 119](#).

10.5 Replacing the system plug

If the system plug is damaged or defective, you must replace it.



NOTICE

Enclosure rating IP65 only applies if the safety laser scanner is closed and the system plug is mounted.



NOTICE

If the system plug is mounted with excessive force, the contacts can break or bend.

- ▶ Plug in the system plug carefully.
- ▶ Do not force it.

Tool required:

- TX10 Torx wrench

Procedure



1. Make sure that the environment is clean and clear of fog, moisture, and dust.
2. Disconnect the connecting cables from the system plug.
3. If necessary: move the safety laser scanner to a clean location.
4. Unscrew the screws in the defective system plug and remove the system plug from the safety laser scanner.
5. Make sure that the seal is seated correctly (①).
6. Carefully place the new system plug onto the safety laser scanner at the back (②).
7. Carefully fold the system plug onto the safety laser scanner (③).
8. Screw in the system plug using the captive screws. Tightening torque: 1.6 Nm ... 1.9 Nm.
9. Reconnect the connecting cables to the system plug.
10. Configure the safety laser scanner, [see "Configuration", page 72](#).
11. Perform commissioning again, taking particular care to conduct all of the thorough checks described, [see "Commissioning", page 119](#).

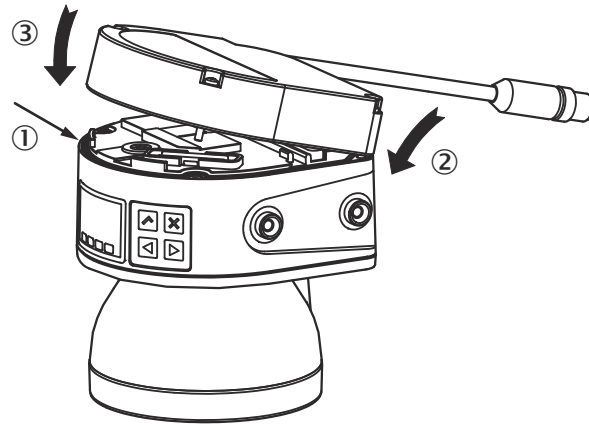

Figure 75: Installing the system plug on the safety laser scanner

10.6 Regular thorough check

The thorough check is intended to ensure that the safety functions are fulfilling their planned purpose and whether persons are being adequately protected.

- ▶ Carry out the checks specified in the test plan of the manufacturer of the machine and the operating entity.

11 Troubleshooting

11.1 Safety



DANGER

Hazard due to lack of effectiveness of the protective device

Persons and parts of the body to be protected may not be recognized in case of non-observance.

- ▶ Immediately shut the machine down if the behavior of the machine cannot be clearly identified.
- ▶ Immediately put the machine out of operation if you cannot clearly identify or allocate the error and if you cannot safely remedy the error.
- ▶ Secure the machine so that it cannot switch on unintentionally.



DANGER

Hazard due to unexpected starting of the machine

- ▶ When any work is taking place, use the protective device to secure the machine or to ensure that the machine is not switched on unintentionally.



NOTE

Additional information on troubleshooting can be found at the responsible SICK subsidiary.

11.2 Detailed diagnostics using the display

Overview

You can open the menu using the pushbuttons.

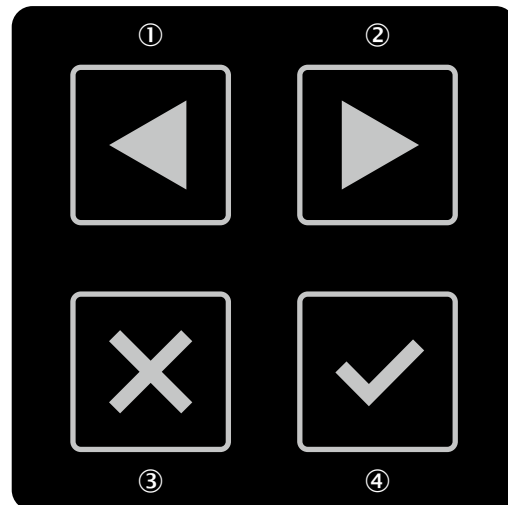

Figure 76: Pushbuttons on the device

- ① Left arrow button
- ② Right arrow button
- ③ Back pushbutton
- ④ OK pushbutton

If you do not press any pushbuttons for a time, the display changes back to the status display.

Menu

The menu provides access to the following areas:

- **Device info**
- **Diagnostics**
- **Device restart**
- **Settings**

Procedure

- ▶ Press the OK pushbutton ④ twice in succession to call up the menu.
- ▶ Use the arrow buttons ①, ② to change to the desired menu item.
- ▶ Confirm the desired menu item using the OK pushbutton ④.
- ▶ Use the same pushbuttons to navigate through the submenus.
- ▶ Press the Back pushbutton ③ to return to the higher-level menu item.
- ▶ Press the Back pushbutton ③ multiple times to return to the status display.
- ▶ Do not press any pushbutton for some time so that the display returns to the status display.

Device info

You will find information about the following subjects in the area:

- **Hardware:** For example type code, part numbers, serial numbers, firmware versions, functional scope of device
- **Configuration:** For example device name, application name, checksum, date of last configuration, functional scope of configuration
- **Service interfaces:** Information on whether access to individual interfaces and services is activated or deactivated

The **Functionality of the device** and **Functionality of the configuration** show whether a configuration is compatible with the firmware version of a device. This can be important when exchanging a device, for example.

Configuration and firmware version of a device are compatible if the following conditions are met:

- The 1st place of both numbers must be identical
- The 2nd place for the device must be at least as large as that for the configuration
- The 3rd place does not have an effect on the compatibility

Diagnostics

Check whether the safety laser scanner is being dazzled by an external light source in the scan plane, e.g., sun, halogen light, infrared light source.

- **Intrusions:** Position and time of the last 10 objects in a protective field that have led to a safety output switching to the OFF state.
- **Messages:** Error code and error type of the last 10 error messages.
- **Service:** Currently measured contamination of the optics cover, operating hours, number of power-up processes.

Device restart

You have the following options in the Device restart area:

- Restart the safety laser scanner.

Settings

You have the following options in the Settings area:

- Set the display brightness and contrast.

Complementary information

The display language is set using Safety Designer during configuration. The display language and the configuration cannot be changed using the pushbuttons on the display.

11.3 Error indication on the display

Overview

If there is an error, the display shows a warning symbol, a type of error and an error code on a red flashing background.

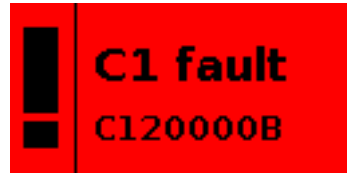

Figure 77: Error display

- The two-character error type will help you during troubleshooting.
- The eight-character error code in the bottom line helps SICK support during the detailed error analysis.
- By pressing any pushbutton, you will obtain more information about the error and for troubleshooting. You can use the arrow buttons to change to further pages with additional information.
- You will find detailed information in Safety Designer's message history about the individual errors and information about events not shown by the display.

Error indication on the display

Table 22: Error types

Error type	Brief description	Cause	Troubleshooting
C1	Faulty configuration	The configuration is faulty.	▶ Reconfigure the device.
C2	Incompatible configuration	The configuration in the system plug does not match the device's functionality.	▶ Check device variant. ▶ Replace or reconfigure the device.
C3	Incompatible firmware	The configuration in the system plug does not match the device's firmware version.	▶ Check the firmware version of the device. ▶ Replace or reconfigure the device.
E1	Error in the safety laser scanner	The safety laser scanner has an internal error.	▶ Perform a device restart using the display or Safety Designer or interrupt the voltage supply for at least two seconds. ▶ Replace the safety laser scanner and send it to the manufacturer for repair.
E2	Error in the system plug	The system plug has an internal error.	▶ Perform a device restart using the display or Safety Designer or interrupt the voltage supply for at least two seconds. ▶ Replace the system plug.
E3	Error in the system plug	The system plug has an internal error.	▶ Perform a device restart using the display or Safety Designer or interrupt the voltage supply for at least two seconds. ▶ Replace the system plug.

Error type	Brief description	Cause	Troubleshooting
E4	Incompatible system plug	The system plug is unsuitable for the safety laser scanner.	<ul style="list-style-type: none"> ▶ Check part number or type code. ▶ Replace the system plug.
E5	Dazzle error	Strong external light source, e.g., sun, halogen headlamps, infrared light source, stroboscope.	<ul style="list-style-type: none"> ▶ Remove or cover the light source. ▶ Perform a device restart using the display or Safety Designer or interrupt the voltage supply for at least two seconds.
F1	Current too high at an OSSD	The current is too high at an OSSD. The limit has been exceeded for current allowed short-term or permanently.	<ul style="list-style-type: none"> ▶ Check the connected switching element.
F2	OSSD short-circuit to 24 V	There is a short-circuit to 24 V at an OSSD.	<ul style="list-style-type: none"> ▶ Check wiring.
F3	OSSD short-circuit to 0 V	There is a short-circuit to 0 V at an OSSD.	<ul style="list-style-type: none"> ▶ Check the wiring.
F4	Short-circuit between 2 OSSDs	There is a short-circuit between two OSSDs.	<ul style="list-style-type: none"> ▶ Check the wiring.
F5	Short-circuit between OSSD and universal input or universal I/O	There is a short-circuit between an OSSD and a universal input or between an OSSD and a universal I/O.	<ul style="list-style-type: none"> ▶ Check wiring.
F9	General OSSD error	At least one OSSD is showing unexpected behavior.	<ul style="list-style-type: none"> ▶ Check the wiring of the OSSDs.
L2	Invalid configuration of the external device monitoring (EDM)	The configuration of the external device monitoring (EDM) is invalid. The configuration is unsuitable for the wiring.	<ul style="list-style-type: none"> ▶ Check whether the external device monitoring is connected correctly. ▶ Use Safety Designer to check the configuration.
L3	Error in the external device monitoring (EDM)	A faulty signal is applied at the external device monitoring (EDM). The allowed tolerance time has been exceeded.	<ul style="list-style-type: none"> ▶ Check whether the connectors are wired correctly and operating correctly.
L8	Error in the reset input	An invalid signal is applied at a reset input. The reset signal is applied for too long.	<ul style="list-style-type: none"> ▶ Check the reset pushbutton, the wiring, and any other components affected.
L9	Short-circuit at the reset input	Exactly the same signal is applied at a reset input as at another input, an OSSD or an output. There is possibly a short-circuit.	<ul style="list-style-type: none"> ▶ Check the wiring for cross-circuits.
N1	Invalid input signal	The signal applied at the control inputs is not assigned to a monitoring case. The signal is applied for longer than the set input delay +1 s.	<ul style="list-style-type: none"> ▶ Check the configuration with Safety Designer. ▶ Check the working process of the machine.
N2	Incorrect switching sequence	The configured switching sequence was interrupted by the new monitoring case.	<ul style="list-style-type: none"> ▶ Check the machine's work process. ▶ Change the configured switching sequence monitoring.
N3	Invalid input signal	The signal applied at the static control inputs does not match the complementary condition. The signal is applied for longer than 1 s.	<ul style="list-style-type: none"> ▶ Check the control of the control inputs.
T1	Temperature error	The operating temperature of the safety laser scanner has exceeded or fallen below the permitted range.	<ul style="list-style-type: none"> ▶ Check whether the safety laser scanner is being operated in accordance with the permissible ambient conditions.

Error type	Brief description	Cause	Troubleshooting
W1	Warnings exceed tolerance time	The combination of multiple warnings has resulted in an error. The tolerance time of 1 s has been exceeded as there are multiple warnings.	► Use Safety Designer to check what warnings exist.

11.4 Diagnostics using Safety Designer

The following diagnostics tools are available in the device window:

- Data recorder
- Event history
- Message history

The following interfaces are suitable for diagnostics:

- USB 2.0 mini-B (female connector) ⁷⁾

11.4.1 Data recorder

Overview

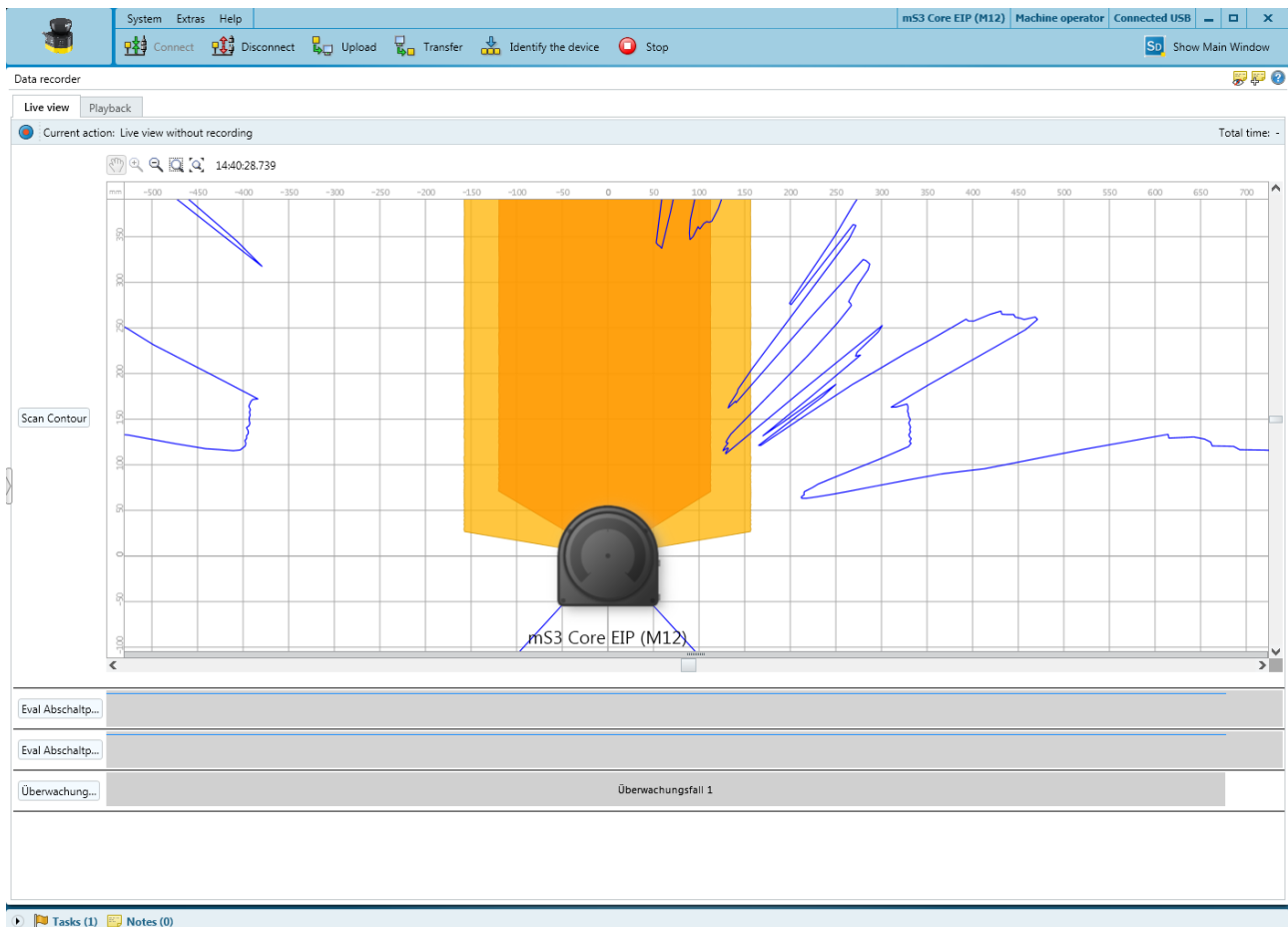

Figure 78: Data recorder

You can use the data recorder to record the device's signals. Depending on the interface and the load on the interface, the measurement data may not be transmitted and shown for every scan cycle.



⁷⁾ The USB connection may only be used temporarily and only for configuration and diagnostics.

The data is saved in a data recorder diagnostics file.

You can play the data recorder diagnostic file in the data recorder.

You can adjust the settings in the Safety Designer main window.

Table 23: Data recorder

	Start recording
	Stop recording
	Full screen mode

Typical applications

- Check spatial geometry
- Check where a person can stay or when a person is detected
- Check input information about the current monitoring case
- Check why safety outputs have switched

Prerequisites

- Existing connection between Safety Designer and device
- Configuration in the project and configuration in the device are synchronized

Procedure

1. Import configuration from the device.
2. Take an image.

Complementary information

Reflectors are displayed in turquoise if they are detected at a distance of more than approx. 0.5 m.

11.4.2 Event history

Overview

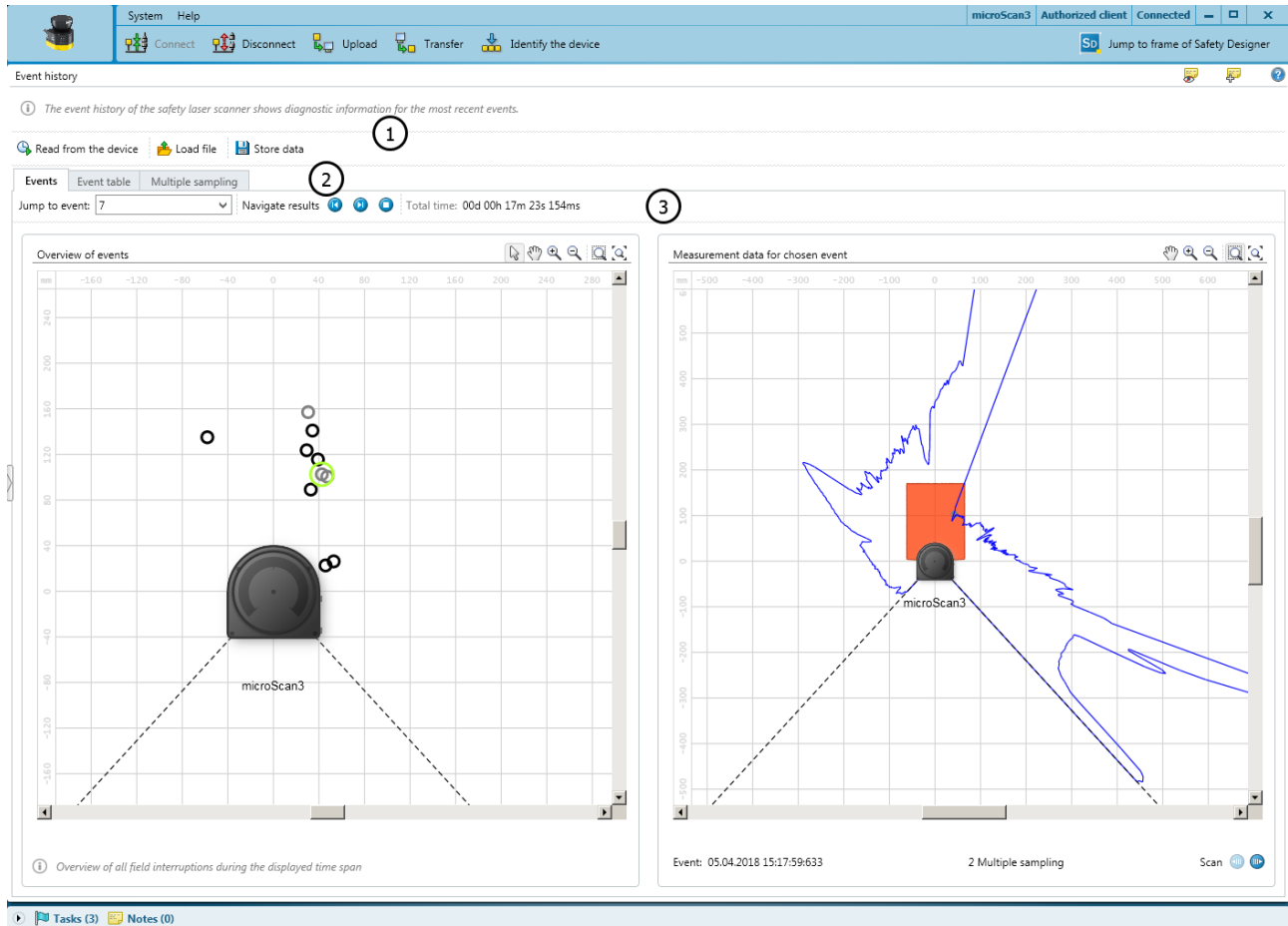

Figure 79: Event history

- ① Data source
- ② Available views
- ③ Navigation

The safety laser scanner stores data on important events. The event history displays information about the most recently stored events.

Event memory in the safety laser scanner

The safety laser scanner stores data on the following events:

- Safety output switches to the OFF state.
- An object is detected in a safety-related field.

For each object detection where a safety output switches to the OFF state, the safety laser scanner stores the data from 10 scans. When the internal memory of the safety laser scanner is full, the scan data of the oldest object detection is overwritten to store a new object detection. The position and time of the object detection are retained.

The internal memory of the safety laser scanner is cleared during a restart and when transferring a configuration.

Data source

- **Read from device:** Only available when a device is connected. The data stored in the device will be read.
- **Load file:** You can open a file that stores events that were previously read from a device.
- **Store data:** You can save the events read from a device to a file for later analysis.

Events

The **Events** view shows a graphical overview of the object detections in safety-related fields that have led to a safety output switching to the OFF state.

- **Navigation:** You can select the event whose measurement data is displayed in the right area.
- **Overview of events:** The position of each recorded object detection relative to the safety laser scanner is displayed. If you hold the mouse pointer on a position, the set multiple sampling is displayed. When you click a position, the corresponding measurement data is displayed in the right-hand area.
- **Measurement data for the selected event:** The measurement data of the selected object detection is displayed. If multiple scans are stored for the selected object detection, you can view the individual scans one by one by clicking on the icons next to **Scan**.

Event table

The event table shows detailed information about the events which have led to a safety output switching to the OFF state.

Based on the measurement data, a probable cause is assigned to each event:

- **Object:** An object was probably detected in the protective field.
- **Contour:** A reference contour field or a contour identification field detects a deviation of the monitored contour.
- **Contamination:** The shutdown was triggered by a contamination of the optics cover in the area of the protective field. The displayed distance relates to an object that was detected despite the contamination. This value is not reliable due to the contamination.
- **Glare:** The shutdown was triggered by an external light source in the scan plane in the area of the protective field, e.g., sun, halogen light, infrared light source, stroboscope.
- **Close to field edge or particle in field:** Object detection in the protective field was probably triggered at the edge or by particles.

Multiple sampling

The **Multiple sampling** view shows how often object detections with different durations occurred. All object detections in safety-related fields are taken into account. Therefore, the number of entries in this view may deviate from the other views.

The duration is specified as the number of consecutive scans in which an object is detected in the field. For each duration, the diagram shows the corresponding number of object detections.

11.4.3 Message history

Overview

The screenshot displays the 'Message history' window in Safety Designer. The window title is 'microScan3 Machine operator Connected'. The main area contains a table of messages:

Type	Occurrence	End	Message	Ac...
Warning	08:04:16	-		
Information	08:04:12	-	Monitoring case switching	
Information	08:04:10	-	Connection to network lost	
Information	08:04:10	-	Connection to network lost	
Error	?	Restarted	Connection lost	
Error	?	Restarted	Connection lost	
Error	?	Restarted	Connection lost	
Error	?	Restarted	Connection lost	
Error	?	Restarted	Connection lost	
Error	?	Restarted	Connection lost	
Error	?	Restarted	Connection lost	
Error	?	Restarted	Connection lost	
Error	?	Restarted	Connection lost	
Error	?	Restarted	Connection lost	
Error	?	Restarted	Connection lost	
Error	?	Restarted	Connection lost	
Error	?	Restarted	Connection lost	
Error	?	Restarted	C1 - Faulty configuration	
Error	?	Restarted	C1 - Faulty configuration	

The details pane at the bottom shows the following information for the selected message:

Code	0x43120000
Reason	Monitoring case switching from: 0 to: 1
Monitoring case selection number	1
New monitoring case: 1	1
Previous monitoring case: 0	0
The speed monitoring state: - 0:	0
Speed monitoring not active - 1:	
Speed monitoring active	

Figure 80: Message history



- ① Message history
- ② Display filter
- ③ Details about the selected message

Events such as errors, warnings and information are stored in the message history.

By right-clicking on the table header, you can select the columns displayed in the message history.

Safety Designer shows details about the events in the bottom part of the window, ways to solve them are also shown.

Table 24: Print or export message history

	Print message history
	Save message history as a PDF
	Save message history as CSV

12 Decommissioning

12.1 Disposal

Procedure

- ▶ Always dispose of unusable devices in accordance with national waste disposal regulations.



Complementary information

SICK will be glad to help you dispose of these devices on request.

13 Technical data

13.1 Variant overview

Ordering information: see "Ordering information", page 158.

Table 25: Devices and type codes

Performance package Integration in the control	Protective field range	Device without system plug	System plug	Device with system plug
<ul style="list-style-type: none"> Core I/O 	≤ 4.0 m	MICS3-AAA40AZ1	MICSX-ABIZZZZ1	MICS3-AAA40AZ1P01
	≤ 5.5 m	MICS3-AAA55AZ1		MICS3-AAA55AZ1P01
	≤ 9.0 m	MICS3-AAA90AZ1		MICS3-AAA90AZ1P01

13.2 Version numbers and functional scope

Functional scope

Older devices might not support the full functional scope of the latest Safety Designer.

To identify the different levels of the functionality, we use a 3-digit version number. The version number is marked with the letter V on the device.

The functional scope of the device can be read at the following locations:

- Label on the device
- Display, entry in **Device info** menu at **Hardware**
- Safety Designer, **Overview** dialog (only with connected device)
- Safety Designer, report

Table 26: Functional scope of the microScan3 Core I/O (devices with a max. protective field range of 4.0 m and devices with max. protective field range of 5.5 m)

Version number	Amendments and new functions
V 1.0.0	<ul style="list-style-type: none"> • First released version
V 1.1.0	<ul style="list-style-type: none"> • Improved separation of the checksum from the Safety Designer version
V 1.2.0	<ul style="list-style-type: none"> • Option to adjust the settings for multiple sampling after switching between monitoring cases • New rights management using user group Administrator (now 4 user groups) • Additional third option for resetting to factory settings • Modified process for resetting the password • Deviating multiple sampling after object detection can be configured • Interfaces and selected functions can be activated or deactivated • New Always ON (NON-safe) function in monitoring case tables

Table 27: Functional scope of the microScan3 Core I/O (devices with a max. protective field range of 9.0 m)

Version number	Amendments and new functions
V 1.0.0	<ul style="list-style-type: none"> • First published version (including improved separation of the checksum from the Safety Designer version)

Version number	Amendments and new functions
V 1.1.0	<ul style="list-style-type: none"> • Option to adjust the settings for multiple sampling after switching between monitoring cases • New rights management using user group Administrator (now 4 user groups) • Additional third option for resetting to factory settings • Modified process for resetting the password • Deviating multiple sampling after object detection can be configured • Interfaces and selected functions can be activated or deactivated • New Always ON (NON-safe) function in monitoring case tables

Revision

The different revision statuses of the devices are identified by “Rev” followed by a three-digit version number. New devices have a label which indicates the revision status.

Table 28: Revision

Version number	Amendments and new functions
Rev 1.0.0	<ul style="list-style-type: none"> • First released version
Rev 1.1.0	<ul style="list-style-type: none"> • Internal change to components, no change in function
Rev 1.2.0	<ul style="list-style-type: none"> • Internal change to components, no change in function
Rev 1.3.0	<ul style="list-style-type: none"> • Adaptation of detection behavior for optimized safety and availability
Rev 1.4.0	<ul style="list-style-type: none"> • Improved compatibility with old system plugs
Rev 1.5.0	<ul style="list-style-type: none"> • Internal change to components, no change in function
Rev 1.6.0	<ul style="list-style-type: none"> • Internal change to components, no change in function

In some cases, new system plugs are not suitable for older devices.

New system plugs have a label which indicates the devices for which they are suitable.

Table 29: Compatibility

Label on the device	Label on the system plug	Compatible
-	-	Yes
-	Only compatible with Rev ≥ 1.1.0	Information is available from your SICK subsidiary.
Rev 1.1.0 (or higher)	-	Yes
Rev 1.1.0 (or higher)	Only compatible with Rev ≥ 1.1.0	Yes

13.3 Data sheet

13.3.1 microScan3 Core I/O

Features

Table 30: Features

microScan3 Core I/O	
Protective field range	
Devices with a max. protective field range of 4.0 m	≤ 4.0 m, details: see "Sensing range", page 153
Devices with a max. protective field range of 5.5 m	≤ 5.5 m, details: see "Sensing range", page 153

microScan3 Core I/O	
Devices with a max. protective field range of 9.0 m	≤ 9.0 m, details: see "Sensing range", page 153
Scanning range of the reference contour field	Same as protective field range, see "Sensing range", page 153
Scanning range of the contour detection field	Same as protective field range, see "Sensing range", page 153
Warning field range	
Devices with a max. protective field range of 4.0 m	≤ 40 m
Devices with a max. protective field range of 5.5 m	≤ 40 m
Devices with a max. protective field range of 9.0 m	≤ 64 m
Distance measurement range	
Devices with a max. protective field range of 4.0 m	≤ 40 m
Devices with a max. protective field range of 5.5 m	≤ 40 m
Devices with a max. protective field range of 9.0 m	≤ 64 m
Fields	≤ 8
Simultaneously monitored fields	≤ 4
Field sets	≤ 8
Monitoring cases	≤ 2
Scanning angle	275° (-47.5° ... 227.5°)
Protective field resolution	30 mm, 40 mm, 50 mm, 60 mm, 70 mm, 150 mm, 200 mm ¹⁾
Angular resolution	
Devices with a max. protective field range of 4.0 m	
Scan cycle time 30 ms	0.51°
Scan cycle time 40 ms	0.39°
Devices with a max. protective field range of 5.5 m	
Scan cycle time 30 ms	0.51°
Scan cycle time 40 ms	0.39°
Devices with a max. protective field range of 9.0 m	
Scan cycle time 40 ms	0.125°
Scan cycle time 50 ms	0.1°
Response time	
Devices with a max. protective field range of 4.0 m	≥ 70 ms, details: see "Response times", page 151
Devices with a max. protective field range of 5.5 m	≥ 70 ms, details: see "Response times", page 151
Devices with a max. protective field range of 9.0 m	≥ 90 ms, details: see "Response times", page 151
Scan cycle time	
Devices with a max. protective field range of 4.0 m	30 ms or 40 ms (adjustable)

microScan3 Core I/O	
Devices with a max. protective field range of 5.5 m	30 ms or 40 ms (adjustable)
Devices with a max. protective field range of 9.0 m	40 ms or 50 ms (adjustable)
Generally necessary protective field supplement (TZ = tolerance zone of the safety laser scanner)	
Devices with a max. protective field range of 4.0 m	65 mm
Devices with a max. protective field range of 5.5 m	65 mm
Devices with a max. protective field range of 9.0 m	100 mm
Additional supplement Z_R for reflection-based measurement errors	350 mm
Deviation from ideal flatness of scan field at 5.5 m ²⁾	≤ ±100 mm
Deviation from ideal flatness of scan field at 9.0 m ³⁾	≤ ± 100 mm
Distance of mirror rotational axis (zero point of x and y axis) to mounting surface on rear side of device	56 mm
Distance between center point of scan plane and top edge of the housing	40 mm
Multiple sampling	2 ... 16

- 1) Protective field resolution 60 mm only available for devices with max. protective field range of 9.0 m.
- 2) Devices with a max. protective field range of 4.0 m and devices with max. protective field range of 5.5 m.
- 3) Devices with a max. protective field range of 9.0 m.

Safety technology parameters

Table 31: Safety-related parameters

microScan3 Core I/O	
Type	Type 3 (IEC 61496)
Safety integrity level	SIL 2 (IEC 61508)
SIL claim limit	SILCL 2 (IEC 62061)
Category	Category 3 (ISO 13849-1)
Performance level	PL d (ISO 13849-1)
PFH_D (mean probability of a dangerous failure per hour)	8 × 10 ⁻⁸
T_M (mission time)	20 years (ISO 13849-1)
Safe status when an error occurs	At least one OSSD is in the OFF state.

Interfaces

Table 32: Interfaces

microScan3 Core I/O	
OSSD pairs	1

microScan3 Core I/O	
Automated restart of OSSDs after	2 s ... 60 s (configurable)
Voltage supply	
Connection type	Male connector, M12, 8 pin, A-coding (collective male connector for voltage supply and inputs and outputs)
Length of cable (power supply unit tolerance $\pm 5\%$)	
Length of cable with 0.25 mm^2 conductor cross section	$\leq 35 \text{ m}$
Local inputs and outputs	
Connection type	Male connector, M12, 8 pin, A-coding (collective male connector for voltage supply and inputs and outputs)
Length of cable with wire cross-section 0.25 mm^2	$\leq 35 \text{ m}$
USB	
Connection type	USB 2.0 mini-B (female connector)
Transmission rate	$\leq 12 \text{ Mbit/s}$
Length of cable	$\leq 5 \text{ m}$

Electrical data

Table 33: Electrical data

microScan3 Core I/O	
Operating data	
Protection class	III (IEC 61140)
Supply voltage V_S	24 V DC (16.8 V ... 30 V DC) (SELV/PELV) ¹⁾
Residual ripple	$\pm 5\%$ ²⁾
Start-up current at 24 V	$\leq 3 \text{ A}$
Current consumption at 24 V	
No output load	Typ. 0.3 A
With maximum output load	Typ. 1.4 A
In sleep mode, no output load	Typ. 0.27 A
Power consumption	
No output load	Typ. 7 W
With maximum output load	Typ. 34 W
In sleep mode, no output load	Typ. 6.5 W
Power-up delay	$\leq 12 \text{ s}$
Safety outputs (OSSD)	
Type of output	2 PNP semiconductors for each OSSD pair, short-circuit protected, cross-circuit monitored
Output voltage for ON state (HIGH)	$(U_V - 2.7 \text{ V}) \dots U_V$
Output voltage for OFF state (LOW)	0 V ... 2 V
Output current for ON state (HIGH)	$\leq 250 \text{ mA}$ per OSSD

microScan3 Core I/O	
Leakage current ³⁾	≤ 250 μA
Load inductance	≤ 2.2 H
Load capacity	≤ 2.2 μF in series with 50 Ω
Permissible resistivity between load and device	≤ 2.5 Ω
Test pulse width	≤ 300 μs (typ. 230 μs)
Test pulse interval	
Scan cycle time 30 ms	240 ms ... 264 ms (typ. 240 ms)
Scan cycle time 40 ms	320 ms ... 344 ms (typ. 320 ms)
Scan cycle time 50 ms	400 ms
Duration of OFF state	≥ 80 ms
Discrepancy time (time offset between switching OSSDs of an OSSD pair)	≤ 1 ms (typ. 25 μs)
Universal output, universal I/O (configured as output)	
Output voltage HIGH	(U _V - 3.7 V) ... U _V
Output voltage LOW	0 V ... 2 V
Output current HIGH	≤ 200 mA
Leakage current	≤ 0.5 mA
Switch-on delay time	40 ms
Switch off delay	40 ms
Static control input, universal input, universal I/O (configured as input)	
Input voltage HIGH	24 V (13 V ... 30 V)
Input voltage LOW	0 V (-30 V ... 5 V)
Input current HIGH	3 mA ... 6 mA
Input current LOW	0 mA ... 2 mA
Input resistance at HIGH	Typ. 5 kΩ
Input capacitance	10 nF
Input frequency (max. switching sequence when used as control input)	≤ 20 Hz
Sampling time	4 ms
Response time at EDM after switching on OSSDs (when used as EDM input)	300 ms
Actuating duration of control switch for reset (when used as reset input)	60 ms ... 30 s
Actuating duration of switch for sleep mode (when used as sleep mode input)	≥ 120 ms

- 1) The supply voltage must be within the specified range at all times. It must not fall below the lower limit, even for a brief period.
The power supply unit must be able to bridge a brief power failure of 20 ms as specified in IEC 60204-1. Suitable power supply units are available as accessories from SICK.
- 2) The voltage level must not fall below the specified minimum voltage.
- 3) In the event of an error (interruption of the 0 V cable), the specified leak current at most flows in the OSSD cable. The downstream control element must detect this state as the OFF state.

Mechanical data

Table 34: Mechanical data

	microScan3 Core I/O
Dimensions (W × H × D)	112 mm × 135.1 mm × 111.1 mm
Weight (including system plug)	1.15 kg
Housing material	Aluminum
Housing color	RAL 9005 (black) and RAL 1021 (colza yellow)
Optics cover material	Polycarbonate
Optics cover surface	Outside has a scratch-resistant coating

Ambient data

Table 35: Ambient data

	microScan3 Core I/O
Enclosure rating ¹⁾	IP65 (IEC 60529)
Ambient light immunity	≤ 40 klx ²⁾
Ambient operating temperature	-10 °C ... 50 °C
Storage temperature	-25 °C ... 70 °C
Air humidity	≤ 95%, non-condensing ³⁾
Height above sea level during operation	≤ 2300 m
Vibration resistance ⁴⁾	
Standards	<ul style="list-style-type: none"> • IEC 60068-2-6 • IEC 60068-2-64 • IEC 60721-3-5 • IEC TR 60721-4-3 • IEC 61496-1 • IEC 61496-3
Class	<ul style="list-style-type: none"> • 5M1 (IEC 60721-3-5) • 3M4 (IEC TR 60721-4-3)
Sinusoidal vibrations	<ul style="list-style-type: none"> • 50 m/s², 0.35 mm, 10 Hz ... 150 Hz • 5 m/s², 1.5 mm, 5 Hz ... 200 Hz • 10 m/s², 3.5 mm, 5 Hz ... 150 Hz
Noise vibrations	<ul style="list-style-type: none"> • 0.5 m²/s³, 5 Hz ... 200 Hz • 0.1 m²/s³, 200 Hz ... 500 Hz
Shock resistance ⁴⁾	
Standards	<ul style="list-style-type: none"> • IEC 60068-2-27 • IEC 60721-3-5 • IEC TR 60721-4-3 • IEC 61496-1 • IEC 61496-3
Class	<ul style="list-style-type: none"> • 5M1 (IEC 60721-3-5) • 3M4 (IEC TR 60721-4-3)
Single shock	50 m/s ² , 11 ms
Continuous shock	<ul style="list-style-type: none"> • 100 m/s², 16 ms • 150 m/s², 6 ms

	microScan3 Core I/O
EMC	In accordance with IEC 61496-1, IEC 61000-6-2, and IEC 61000-6-4

- 1) The specified enclosure rating is only valid if the safety laser scanner is closed, the system plug is mounted, and all of the M12 plug connectors of the safety laser scanner have been closed using a cable plug connector or using a protective cap.
- 2) For ambient light sources directly in the scan plane in accordance with IEC 61496-3: ≤ 3 klx.
- 3) IEC 61496-1, no. 4.3.1 and no. 5.4.2, IEC 61496-3, no. 4.3.1 and no. 5.4.2. Condensation has an influence on normal operation.
- 4) In direct mounting.

Miscellaneous data

Table 36: Miscellaneous data

	microScan3 Core I/O
Wavelength	845 nm
Detectable remission	1.8% ... several 1000%
Maximum uniform contamination of the optics cover without reducing the detection capability ¹⁾	30%
Area where detection capability is restricted	≤ 50 mm ²⁾
Light spot size ³⁾	
Devices with a max. protective field range of 4.0 m	
At front screen	18 mm × 4 mm
At 4.0 m distance	5 mm × 11 mm
At 5.5 m distance	2 mm × 18 mm
At 9.0 m distance	11 mm × 27 mm
Devices with max. protective field range 5.5 m	
At front screen	18 mm × 4 mm
At 4.0 m distance	5 mm × 11 mm
At 5.5 m distance	2 mm × 18 mm
At 9.0 m distance	11 mm × 27 mm
Devices with max. protective field range 9.0 m	
At front screen	18 mm × 4 mm
At 4.0 m distance	8 mm × 14 mm
At 5.5 m distance	4 mm × 19 mm
At 9.0 m distance	2 mm × 30 mm
Divergence of collimated beam	0.17°
Receiving angle	0.75°
Pulse duration	Typ. 4 ns
Average output power	9.2 mW
Laser class	1M

- 1) In the event of heavy contamination, the safety laser scanner displays a contamination error and switches all safety outputs to the OFF state.
- 2) In close proximity (50 mm-wide area in front of the optics cover), the detection capability of the safety laser scanner may be restricted. If required, this area must be secured using an undercut or frame, for example.
- 3) W × H when the laser beam exits at a 90° angle to the front.

13.4 Response times

The protective device's response time is the maximum time between the occurrence of the event leading to the sensor's response and supply of the switch-off signal to the protective device's interface (for example OFF state of the OSSD pair).



DANGER

Hazard due to lack of effectiveness of the protective device

In the case of non-compliance, it is possible that the dangerous state of the machine may not be stopped or not stopped in a timely manner.

In addition to the protective device's response time, further signal transmission and processing also influence the time up until the end of the dangerous state. This includes a control's processing time and the response times of downstream contactors, for example.

- ▶ Take the time for further signal transmission and processing into account.

Response time

The safety laser scanner's response time depends on the following parameters:

- Scan cycle time
- Set interference protection
- Set multiple sampling

You can calculate the response time using the following formula:

$$t_R = (t_S + t_I) \times n + t_O$$

The following rules apply:

- t_R = response time
- t_S = scan cycle time
 - Setting "30 ms": $t_S = 30$ ms
 - Setting "40 ms": $t_S = 40$ ms
 - Setting "50 ms": $t_S = 50$ ms
- t_I = time for interference protection
 - Mode 1 (default): $t_I = 0$ ms
 - Mode 2: $t_I = 1$ ms
 - Mode 3: $t_I = 2$ ms
 - Mode 4: $t_I = 3$ ms
- n = set multiple sampling
Preset to $n = 2$.

Multiple sampling can be changed for the safety laser scanner or for each individual field ($2 \leq n \leq 16$).

- t_O = time for processing and output
Dependent on output used:
 - OSSD pair 1: $t_O = 10$ ms

Table 37: Response time of an individual safety laser scanner

Scan cycle time (t_S)	Interference protection (t_I)		Output (t_O)	t_R = response time for multiple sampling n
30 ms	Mode 1	0 ms	OSSD pair 1	$n \times 30$ ms + 10 ms
	Mode 2	1 ms	OSSD pair 1	$n \times 31$ ms + 10 ms
	Mode 3	2 ms	OSSD pair 1	$n \times 32$ ms + 10 ms
	Mode 4	3 ms	OSSD pair 1	$n \times 33$ ms + 10 ms

Scan cycle time (t_s)	Interference protection (t_i)		Output (t_o)	t_R = response time for multiple sampling n
40 ms	Mode 1	0 ms	OSSD pair 1	$n \times 40 \text{ ms} + 10 \text{ ms}$
	Mode 2	1 ms	OSSD pair 1	$n \times 41 \text{ ms} + 10 \text{ ms}$
	Mode 3	2 ms	OSSD pair 1	$n \times 42 \text{ ms} + 10 \text{ ms}$
	Mode 4	3 ms	OSSD pair 1	$n \times 43 \text{ ms} + 10 \text{ ms}$
50 ms	Mode 1	0 ms	OSSD pair 1	$n \times 50 \text{ ms} + 10 \text{ ms}$

13.5 Course of the OSSD test over time

The safety laser scanner tests the OSSDs at regular intervals. To do this, the safety laser scanner switches each active OSSD briefly (for max. 300 μ s) to the OFF state and checks whether this channel is voltage-free during this time.

Make sure that the machine's control does not react to these test pulses and the machine does not switch off.

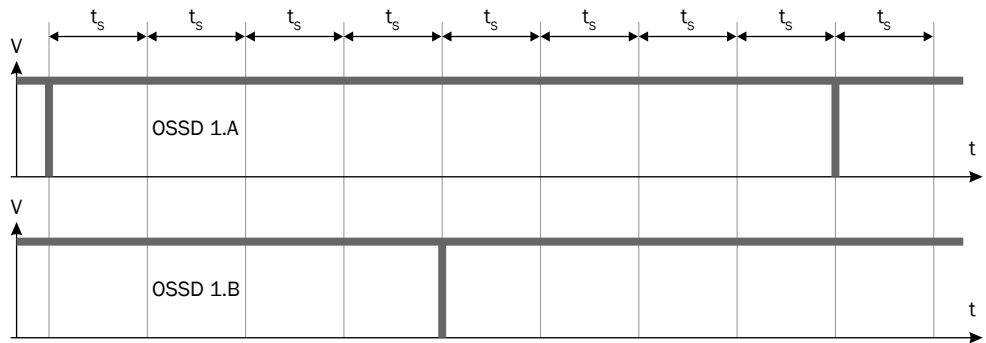

Figure 81: Switch-off tests

- t_s Scan cycle time
- Setting "30 ms": $t_s = 30 \text{ ms}$
 - Setting "40 ms": $t_s = 40 \text{ ms}$
 - Setting "50 ms": $t_s = 50 \text{ ms}$

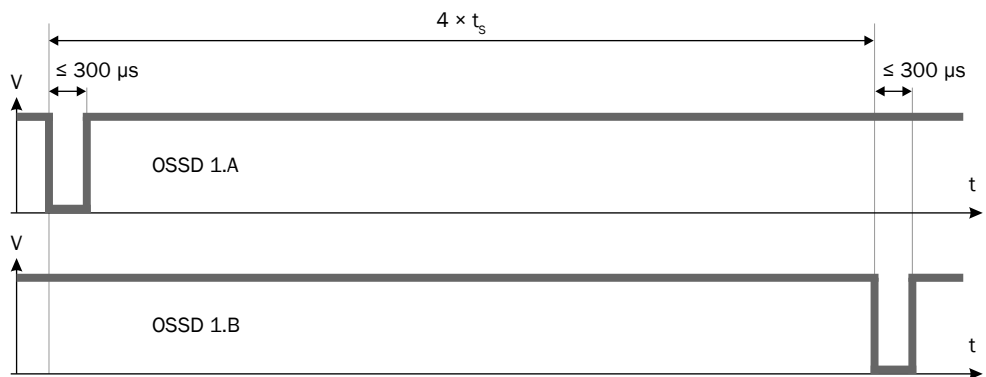

Figure 82: Duration and time offset for the switch-off tests in an OSSD pair

- t_s Scan cycle time
- Setting "30 ms": $t_s = 30 \text{ ms}$
 - Setting "40 ms": $t_s = 40 \text{ ms}$
 - Setting "50 ms": $t_s = 50 \text{ ms}$

13.6 Sensing range

Protective field range

The effective protective field range depends on the variant, on the set scan cycle time and on the set object resolution.

Table 38: Protective field range (devices with a max. protective field range of 4.0 m)

Resolution	Scan cycle time 40 ms	Scan cycle time 30 ms
≥ 70 mm	4.00 m	4.00 m
50 mm	3.50 m	3.00 m
40 mm	3.00 m	2.30 m
30 mm	2.30 m	1.70 m

Table 39: Protective field range (devices with a max. protective field range of 5.5 m)

Resolution	Scan cycle time 40 ms	Scan cycle time 30 ms
≥ 70 mm	5.50 m	4.00 m
50 mm	3.50 m	3.00 m
40 mm	3.00 m	2.30 m
30 mm	2.30 m	1.70 m

Table 40: Protective field range (devices with a max. protective field range of 9.0 m)

Resolution	50 ms scan cycle time	40 ms scan cycle time
≥ 150 mm	9.00 m	9.00 m
70 mm	9.00 m	7.00 m
60 mm	8.00 m	6.00 m
50 mm	7.00 m	5.00 m
40 mm	5.00 m	4.00 m
30 mm	4.50 m	3.00 m

Scanning range of the reference contour field

The effective scanning range of the reference contour field is the same as the protective field range.

Scanning range of the contour detection field

The effective scanning range of the contour detection field is the same as the protective field range.

Range for warning fields

For non-safety applications (warning fields), the safety laser scanner has a larger scanning range than the maximum protective field range. The requirements for size and remission factor of objects to be detected are illustrated in the following graphs as a function of the desired scanning range.

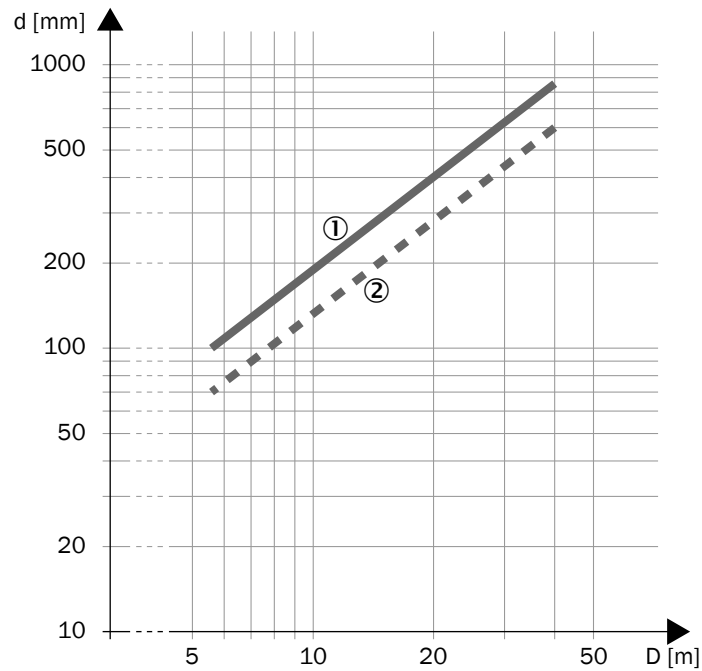

Figure 83: Scanning range and object size for warning fields (devices with a max. protective field range of 4.0 m and devices with max. protective field range of 5.5 m)

- d** Required minimum size of the object in mm
- D** Range in m
- ① Scan cycle time = 30 ms
- ② Scan cycle time = 40 ms

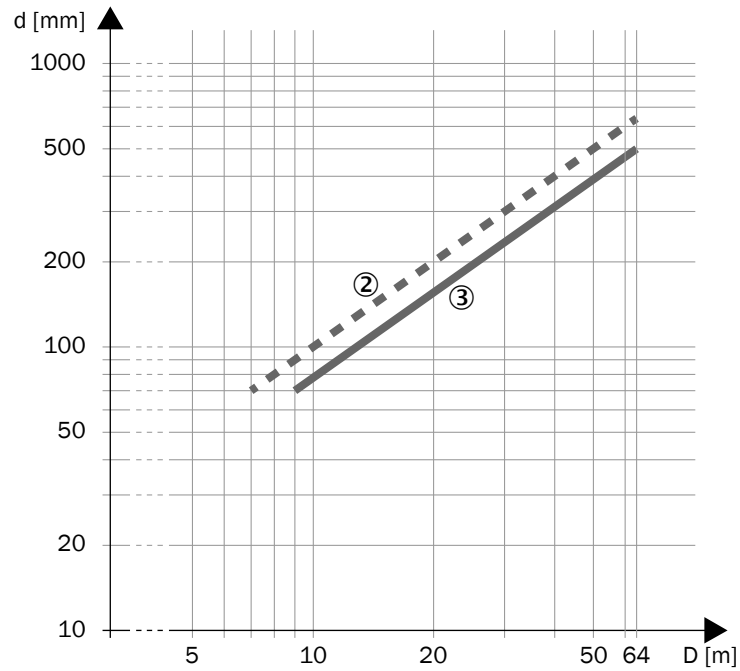

Figure 84: Scanning range and object size for warning fields (devices with a max. protective field range of 9.0 m)

- d** Required minimum size of the object in mm
- D** Scanning range in m
- ② Scan cycle time = 40 ms
- ③ Scan cycle time = 50 ms

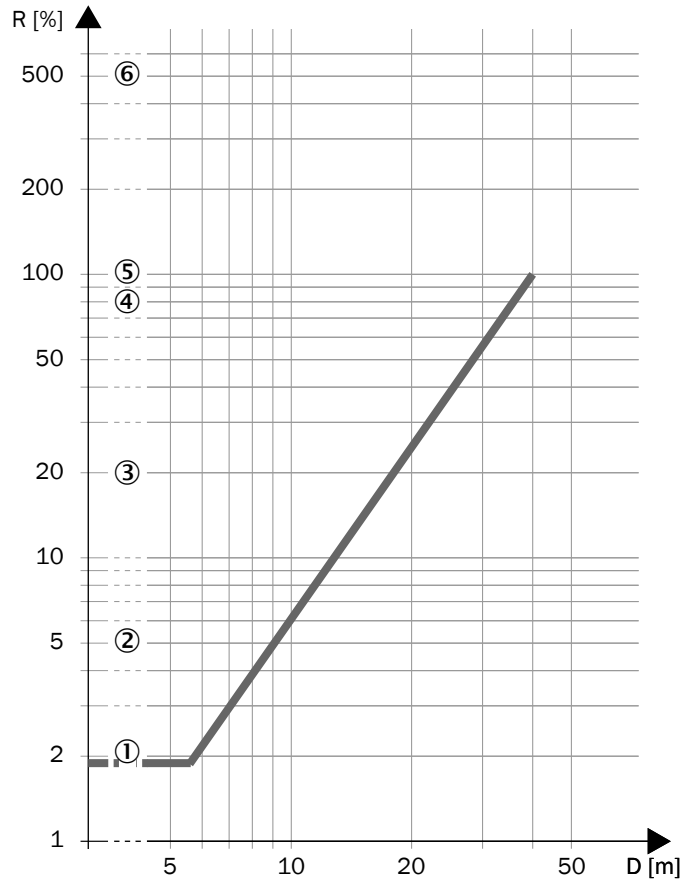

Figure 85: Scanning range and required remission for warning fields (devices with a max. protective field range of 4.0 m and devices with max. protective field range of 5.5 m)

- R** Required minimum remission in %
- D** Range in m
- ① Black shoe leather
- ② Matt black paint
- ③ Gray cardboard
- ④ Writing paper
- ⑤ White plaster
- ⑥ Reflectors > 2,000%, reflective tapes > 300%⁸⁾

8) The measured values are less accurate for reflectors or reflective surfaces because the distance measurement is designed for lower remission values.

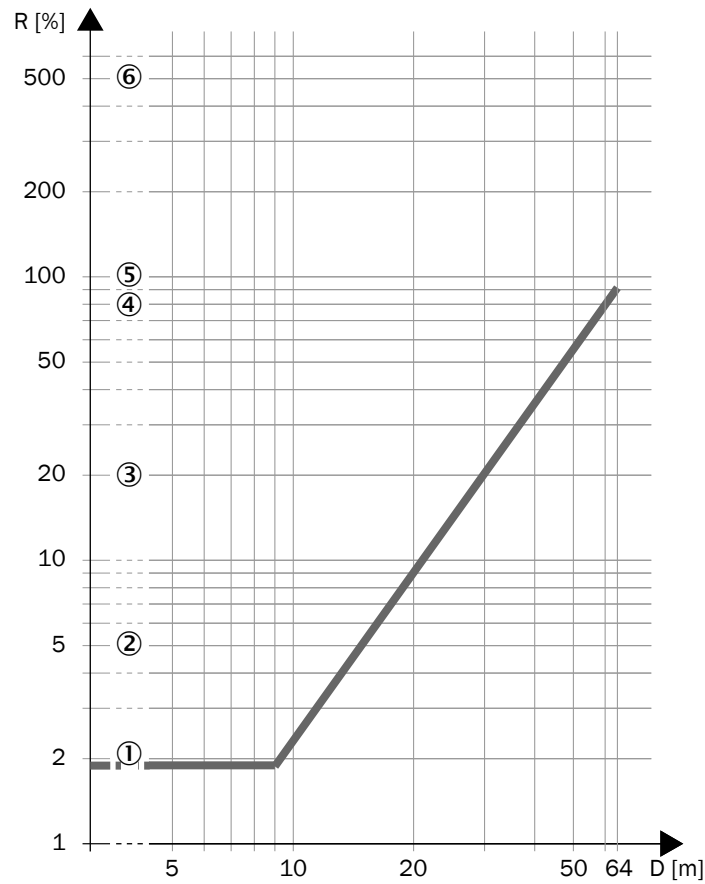

Figure 86: Scanning range and required remission for warning fields (devices with a max. protective field range of 9.0 m)

- R** Required minimum remission in %
- D** Scanning range in m
- ① Black shoe leather
- ② Matt black paint
- ③ Gray cardboard
- ④ Writing paper
- ⑤ White plaster
- ⑥ Reflectors > 2,000%, reflective tapes > 300% ⁹⁾

⁹⁾ The measured values are less accurate for reflectors or reflective surfaces because the distance measurement is designed for lower remission values.

13.7 Dimensional drawings

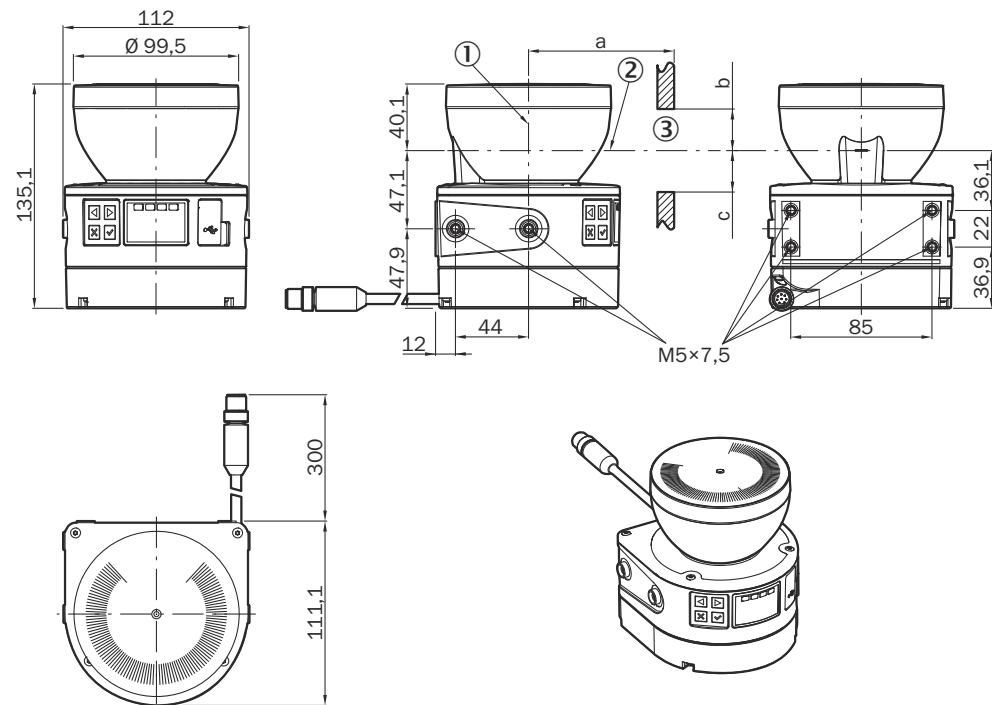

Figure 87: Dimensional drawing

All dimensions in mm.

- ① Mirror rotational axis
- ② Scan plane
- ③ Required viewing slit
 - a: Length of the viewing slit
 - b: Minimum height above the scan plane
 - c: Minimum height below the scan plane

Required viewing slit

If the device is installed in paneling, for example, you must ensure that the laser beam can exit unhindered. The reflected laser beam must also reach the device unhindered. That means the viewing slit must be large enough.

The required minimum height and width of the viewing slit depends on the following parameters, among others:

- Deviation from the ideal flatness of the scan field at the end of the viewing slit
- Light spot size at the end of the viewing slit
- Vibrations that affect the flatness of the scan field or the geometry of the viewing slit

For a viewing slit with length $a \leq 200$ mm, the viewing slit must be at least 50 mm high ($b, c \geq 25$ mm). The viewing slit must be wide enough to leave at least 23 mm of space free next to each field.

If the viewing slit is longer ($a > 200$ mm), a case-by-case consideration is required.

- Contact the responsible SICK subsidiary.

14 Ordering information

14.1 Scope of delivery

- Safety laser scanner with system plug
- Safety note
- Mounting Instructions
- Operating instructions for download: www.sick.com

14.2 Ordering information

Table 41: microScan3 Core I/O ordering information

Integration in the control	Protective field range	Type code	Part number
I/O	≤ 4.0 m	MICS3-AAAZ40AZ1P01	1075842
I/O	≤ 5.5 m	MICS3-AAAZ55AZ1P01	1075843
I/O	≤ 9.0 m	MICS3-AAAZ90AZ1P01	1089492

15 Spare parts

15.1 Safety laser scanner without system plug

Table 42: Safety laser scanner without system plug

Spare part for			Type code	Part number
Device	Part number	Protective field range		
microScan3 Core I/O	1075842	≤ 4.0 m	MICS3-AAA40AZ1	1067360
microScan3 Core I/O	1075843	≤ 5.5 m	MICS3-AAA55AZ1	1067875
microScan3 Core I/O	1089492	≤ 9.0 m	MICS3-AAA90AZ1	1089325

15.2 System plug

Table 43: System plug

Spare part for		Connection type	Type code	Part number
Device	Part number			
microScan3 Core I/O	1075842, 1075843, 1089492	Cable with plug connector	MICSX-ABIZZZZ1	2073156

15.3 Additional spare parts

Table 44: Additional spare parts

Part	Part number
Optics cover (with seal and screws)	2073673

16 Accessories

16.1 Additional accessories

Suitable accessories are available at www.sick.com. Enter the product part number in the search field (part number: see the type label entry in the “Ident. no.” field or in the “P/N” field). All suitable accessories are listed on the Accessories tab of the product page.

17 Glossary

Contour detection field	The contour detection field monitors a contour of the environment. The electro-sensitive protective device switches the associated safety outputs to the OFF state if a contour does not correspond to the set specifications, e.g. because a door or flap is open.
Control input	<p>A control input receives signals, e.g. from the machine or from the control. Use of control inputs is how the protective device receives information about the conditions at the machine, e.g., if there is a change of operating mode. If the protective device is configured appropriately, it will activate a different monitoring case after receiving a new control input.</p> <p>The control input information must be transmitted reliably. Generally, at least 2 separate channels are used to do this.</p> <p>Depending on the device, a control input can be realized as a static control input or a dynamic control input.</p>
Dangerous state	<p>A dangerous state is a status of the machine or facility, where people may be injured. Protective devices prevent this risk if the machine is operated within its intended use.</p> <p>The figures in this document always show the dangerous state of the machine as movement of a machine part. In practice, there are different dangerous states, such as:</p> <ul style="list-style-type: none"> • Machine movements • Electrical parts • Visible and invisible beam • A combination of multiple hazards
EDM	External device monitoring
Electro-sensitive protective device	<p>An electro-sensitive protective device is a device or system of devices for safety-related detection of people or parts of the body. It is used to protect people from machines and facilities that pose a risk of injury. It triggers the machine or facility to adopt a safe state before a person is exposed to a hazardous situation.</p> <p>Examples: Safety light curtain, safety laser scanner.</p>
ESD	Electrostatic discharge
ESPE	Electro-sensitive protective device
External device monitoring	<p>The external device monitoring (EDM) monitors the status of downstream contactors.</p> <p>In order to use external device monitoring, positively guided contactors must be used to switch off the machine. If the auxiliary contacts of the positively guided contactors are connected to the external device monitoring, the external device monitoring checks whether the contactors switch correctly when the OSSDs are switched off.</p>
Field set	<p>A field set consists of one or more fields. The fields in a field set are monitored simultaneously.</p> <p>A field set can contain different field types, e.g., a protective field and a warning field.</p>
Hazardous area	Hazardous area is any space within and/or around machinery in which a person can be exposed to a hazard. (ISO 12100)

Monitoring case	<p>A monitoring case indicates the machine status to the sensor. Generally, one field set is assigned to each monitoring case.</p> <p>The sensor receives a defined signal for the current machine status. When a signal change occurs, the sensor activates the monitoring case and thereby the field set that is associated with the new machine status.</p>
OFF state	<p>The OFF state is the status of the outputs of the protective device, where the controlled machine is triggered to quit its dangerous state and the start-up of the machine is prevented (e.g., the voltage at the OSSDs is LOW, so that the machine is switched off and remains still).</p>
ON state	<p>The ON state is the status of the outputs of the ESPE, where the controlled machine is permitted to operate (e.g., the voltage at the OSSDs is HIGH so that the machine can run).</p>
OSSD	<p>Output signal switching device: signal output for the protective device, which is used for stopping the dangerous movement.</p> <p>An OSSD is a safety switching output. The functionality of each OSSD is tested periodically. OSSDs are always connected in pairs and must undergo dual-channel analysis for safety reasons. An OSSD pair is formed from 2 OSSDs that are connected and analyzed together.</p>
PFH_D	Probability of dangerous failure per hour
PL	Performance level (ISO 13849)
PROFINET	<p>PROFINET (Process Field Protocol) is an Ethernet-based network used in industrial automation.</p> <p>With PROFIsafe , PROFINET is also suitable for safety-oriented data communication.</p>
Protective field	<p>The protective field is the area in which the test object specified by the manufacturer is detected by the electro-sensitive protective equipment (ESPE). As soon as the electro-sensitive protective device detects an object in the protective field, it switches the associated safety outputs to the OFF state. This signal can be passed to controllers resulting in the dangerous state coming to an end, e.g. to stop the machine or the vehicle.</p>
Reference contour field	<p>The contour as reference field monitors a contour of the environment. The safety laser scanner switches all safety outputs to the OFF state if a contour does not match the set parameters, because, for example, the mounting of the safety laser scanner has been changed.</p> <p>National and international standards require or recommend that a reference contour is monitored, if the safety laser scanner is used in vertical operation for hazardous point protection or for access protection.</p>

Reset	<p>When a protective device has sent a stop command, the stopped state must be maintained until a reset device is activated and the machine can be restarted in a second step.</p> <p>The reset brings the protective device back to the monitoring state after it has sent a stop command. The reset also quits the start-up or restart interlock of a protective device, so that the machine can be restarted in a second step.</p> <p>The reset must only be possible, when all safety functions and protective devices are functional.</p> <p>The reset of the protective device must not introduce any movement or dangerous situations itself. The machine is only permitted to start after the reset once a separate start command has been sent.</p> <ul style="list-style-type: none"> • Manual resets are performed using a separate, manually operated device, such as a reset pushbutton. • Automatic resets by the protective device are only permitted in special cases, if one of the following conditions is met: <ul style="list-style-type: none"> ◦ It must not be possible for people to be in the hazardous area without triggering the protective device. ◦ It must be ensured that no people are in the hazardous area during or after the reset.
Resolution	The resolution of an active opto-electronic protective device (also known as the sensor detection capability) is the minimum size of an object for it to be reliably detected.
Response time	The protective device's response time is the maximum time between the occurrence of the event leading to the sensor's response and supply of the switch-off signal to the protective device's interface (for example OFF state of the OSSD pair).
Restart interlock	<p>The restart interlock prevents the machine from automatically starting up, for example after a protective device has responded while the machine is operating or after changing the machine's operating mode.</p> <p>The restart interlock can be implemented in the protective device or in the safety controller.</p> <p>A command to reset the protective device must be given, for example using a reset pushbutton, before the machine can be restarted.</p>
Retroreflector	A retroreflector reflects light back toward the light source largely independently of the alignment of the retroreflector.
Safety function	Function of a machine whose failure can result in an immediate increase of the risk(s). (ISO 12100)
Safety output	<p>A safety output provides safety-related information.</p> <p>Safety outputs are OSSDs, for example, or safety-related information on a safety-related network.</p>
Scan cycle time	<p>The scan cycle time is the time the sensor needs for a complete scan of its detection area.</p> <p>Example: Time required by the mirror of a safety laser scanner for one rotation.</p>
SIL	Safety integrity level
SILCL	SILCL: SIL claim limit. Designation in older versions of IEC 62061. Replaced by SIL in versions from 2021.
Static control input	A static control input is a dual-channel control input, which evaluates the status of every channel as the value 0 or 1. The signal states of one or more static control inputs give a unique signal pattern. This signal pattern activates a monitoring case.

Universal I/O	Universal I/O can be configured as universal input or as universal output.
Universal input	Depending on the device, a universal input can be used for resetting, external device monitoring (EDM), sleep mode, or restarting the protective device, for example. If sleep mode is activated by a universal input, the sleep mode must not be used for safety applications. Certain universal inputs can also be used in pairs as a static control input.
Universal output	The function of a universal output is configurable. Which functions are available depends on the device. Possible signals are, for example: reset required, contamination warning.
Warning field	<p>The warning field monitors larger areas than the protective field. Simple switching functions can be triggered with the warning field, e.g. a warning light or an acoustic signal can be triggered if a person approaches, even before the person enters the protective field.</p> <p>The warning field must not be used for safety applications.</p>

18 Annex

18.1 Conformities and certificates

You can obtain declarations of conformity, certificates, and the current operating instructions for the product at www.sick.com. To do so, enter the product part number in the search field (part number: see the entry in the “P/N” or “Ident. no.” field on the type label).

18.1.1 EU declaration of conformity

Excerpt

The undersigned, representing the manufacturer, herewith declares that the product is in conformity with the provisions of the following EU directive(s) (including all applicable amendments), and that the standards and/or technical specifications stated in the EU declaration of conformity have been used as a basis for this.

- ROHS DIRECTIVE 2011/65/EU
- EMC DIRECTIVE 2014/30/EU
- MACHINERY DIRECTIVE 2006/42/EC

18.1.2 UK declaration of conformity

Excerpt

The undersigned, representing the following manufacturer herewith declares that this declaration of conformity is issued under the sole responsibility of the manufacturer. The product of this declaration is in conformity with the provisions of the following relevant UK Statutory Instruments (including all applicable amendments), and the respective standards and/or technical specifications have been used as a basis.

- Restriction of the Use of Certain Hazardous Substances in Electrical and Electronic Equipment Regulations 2012
- Electromagnetic Compatibility Regulations 2016
- Supply of Machinery (Safety) Regulations 2008

18.2 Note on standards

Standards are specified in the information provided by SICK. The table shows regional standards with similar or identical contents. Not every standard applies to all products.

Table 45: Note on standards

Standard	Standard (regional)
	China
IEC 60068-2-6	GB/T 2423.10
IEC 60068-2-27	GB/T 2423.5
IEC 60204-1	GB/T 5226.1
IEC 60529	GB/T 4208
IEC 60825-1	GB 7247.1
IEC 61131-2	GB/T 15969.2
IEC 61140	GB/T 17045
IEC 61496-1	GB/T 19436.1
IEC 61496-2	GB/T 19436.2
IEC 61496-3	GB 19436.3
IEC 61508	GB/T 20438

Standard	Standard (regional)
	China
IEC 62061	GB 28526
ISO 13849-1	GB/T 16855.1
ISO 13855	GB/T 19876

18.3 Checklist for initial commissioning and commissioning

Checklist for manufacturers or installers for installing electro-sensitive protective device (ESPE)

The details relating to the items listed below must be available no later than when the system is commissioned for the first time. However, these depend on the specific application (the requirements of which must be reviewed by the manufacturer or installer).

This checklist should be retained and kept with the machine documentation to serve as reference during recurring tests.

This checklist does not replace the initial commissioning, nor the regular inspection by qualified safety personnel.

Have the safety rules and regulations been observed in compliance with the directives and standards applicable to the machine?	Yes <input type="checkbox"/> No <input type="checkbox"/>
Are the applied directives and standards listed in the declaration of conformity?	Yes <input type="checkbox"/> No <input type="checkbox"/>
Does the protective device correspond to the required PL/SIL and PFHd in accordance with ISO 13849-1 / IEC 62061 and the required type in accordance with IEC 61496-1?	Yes <input type="checkbox"/> No <input type="checkbox"/>
Is access to the hazardous area or hazardous point only possible through the protective field of the ESPE?	Yes <input type="checkbox"/> No <input type="checkbox"/>
Have appropriate measures been taken to protect (mechanical protection) or monitor (protective devices) any persons or objects in the hazardous area when protecting a hazardous area or hazardous point, and have these devices been secured or locked to prevent their removal?	Yes <input type="checkbox"/> No <input type="checkbox"/>
Are additional mechanical protective measures fitted and secured against manipulation which prevent reaching below, above or around the ESPE?	Yes <input type="checkbox"/> No <input type="checkbox"/>
Has the maximum shutdown and/or stopping time of the machine been measured, specified and documented (at the machine and/or in the machine documentation)?	Yes <input type="checkbox"/> No <input type="checkbox"/>
Has the ESPE been mounted such that the required minimum distance from the nearest hazardous point has been achieved?	Yes <input type="checkbox"/> No <input type="checkbox"/>
Are the ESPE devices properly mounted and secured against manipulation after alignment?	Yes <input type="checkbox"/> No <input type="checkbox"/>
Are the required protective measures against electric shock in effect (protection class)?	Yes <input type="checkbox"/> No <input type="checkbox"/>
Is the control switch for resetting the protective devices (ESPE) or restarting the machine present and correctly installed?	Yes <input type="checkbox"/> No <input type="checkbox"/>
Are the outputs of the ESPE (OSSDs or safety outputs via the network) integrated according to the required PL/SIL in accordance with ISO 13849-1 / IEC 62061 and does the integration correspond to the circuit diagrams?	Yes <input type="checkbox"/> No <input type="checkbox"/>
Has the protective function been checked in compliance with the test notes of this documentation?	Yes <input type="checkbox"/> No <input type="checkbox"/>
Are the specified protective functions effective at every operating mode that can be set?	Yes <input type="checkbox"/> No <input type="checkbox"/>
Are the switching elements activated by the ESPE, e.g. contactors, valves, monitored?	Yes <input type="checkbox"/> No <input type="checkbox"/>
Is the ESPE effective over the entire period of the dangerous state?	Yes <input type="checkbox"/> No <input type="checkbox"/>
Once initiated, will a dangerous state be stopped when switching the ESPE on or off and when changing the operating mode, or when switching to another protective device?	Yes <input type="checkbox"/> No <input type="checkbox"/>

18.4 Mounting methods for protection from interference from systems in close proximity

Due to the safeHDDM® scanning technology, mutual interference of multiple safety laser scanners is unlikely. If many safety laser scanners are operated at the same level in a stationary application, they may nevertheless interfere with one another. We recommend selecting a suitable mounting method to avoid mutual interference. In many cases, you can use the following examples as a guide.



NOTE

You must comply with the standard ISO 13855 when choosing the mounting method.

Mounting multiple safety laser scanners slightly offset and in parallel

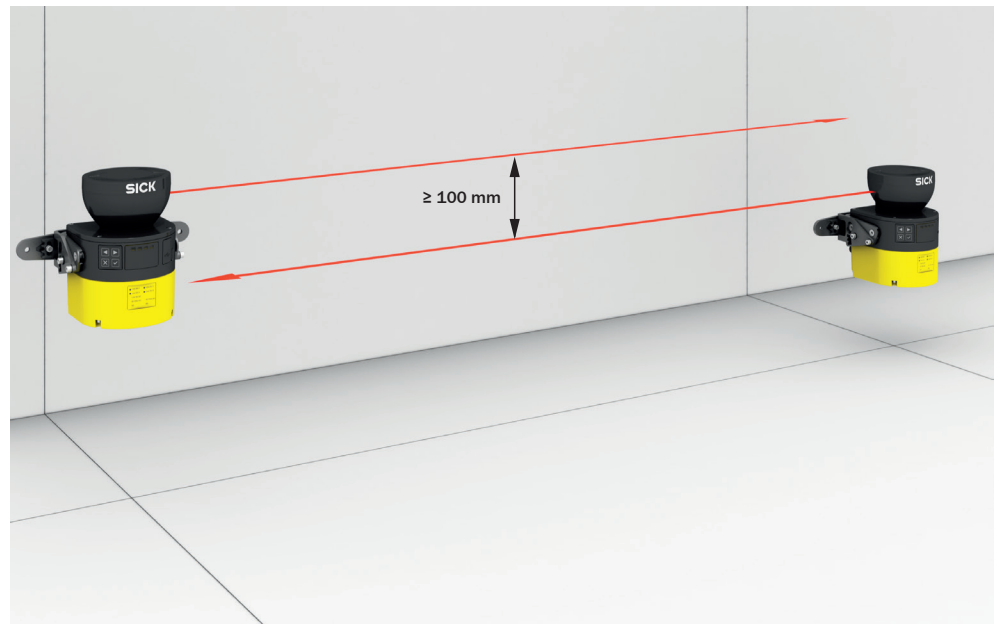

Figure 88: Mounting 2 safety laser scanners with the optics cover facing upward

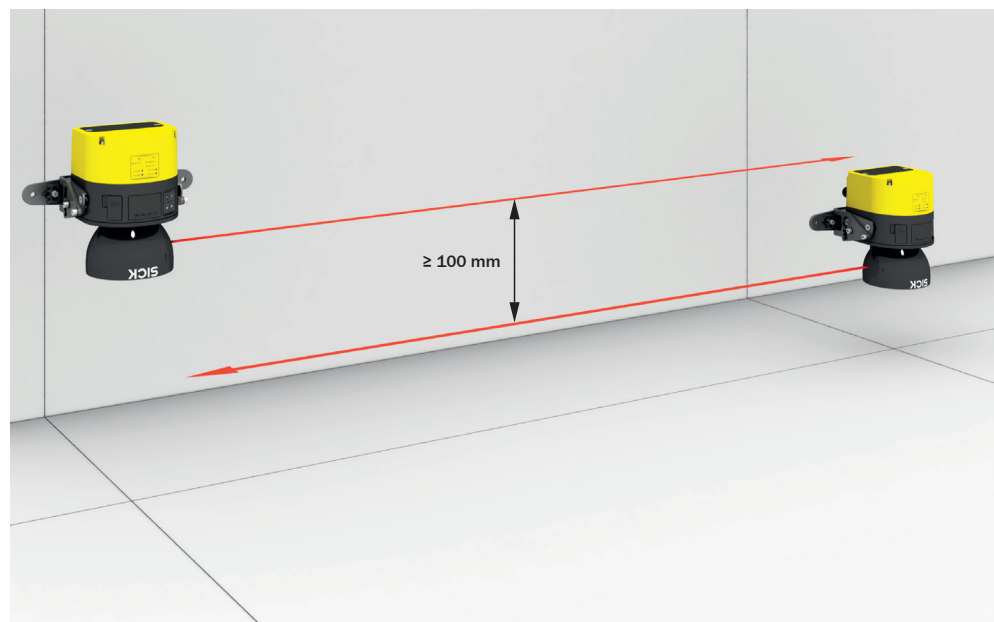

Figure 89: Mounting 2 safety laser scanners with the optics cover facing downward

The following mounting method has the advantage that both safety laser scanners can be mounted at a similar height. Nonetheless, there is enough space between the scan planes.

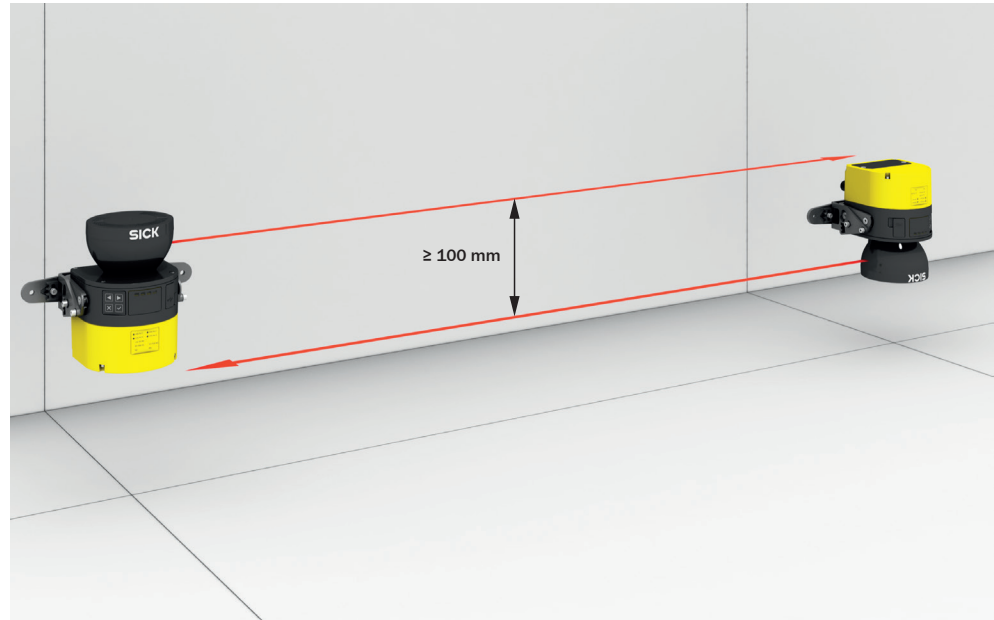

Figure 90: Mounting the upper safety laser scanner with the optics cover facing upward and mounting the lower safety laser scanner with the optics cover facing downward

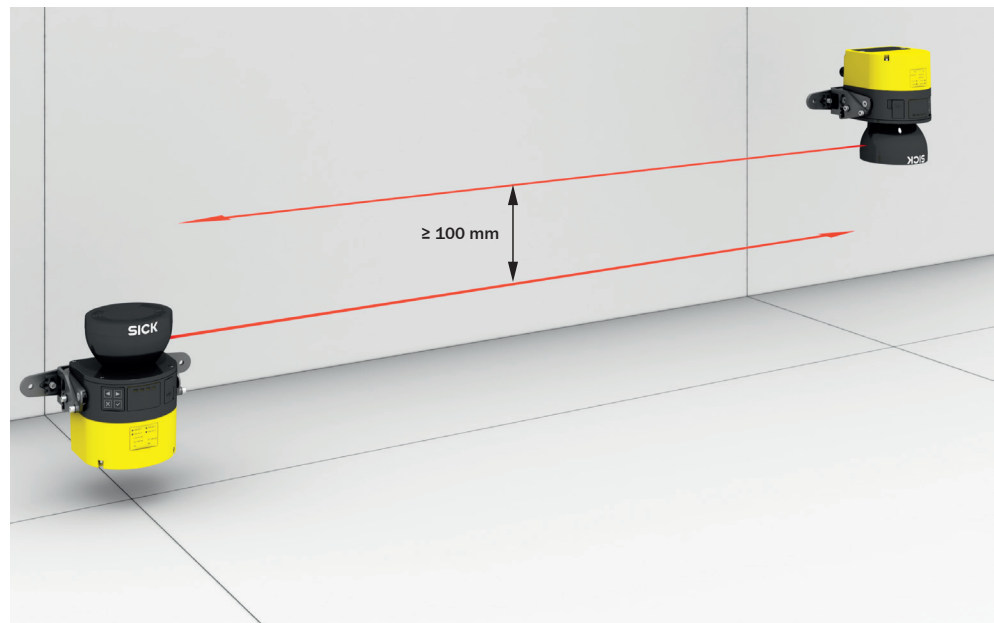

Figure 91: Mounting the upper safety laser scanner with the optics cover facing downward and mounting the lower safety laser scanner with the optics cover facing upward

Mount several safety laser scanners crosswise

If you tilt opposite safety laser scanners with respect to one another, both safety laser scanners must be tilted upward. (If mounted upside down, both safety laser scanners must be tilted downward.)

In any event, ensure that the protective field is at the right height so that crawling beneath and climbing over are prevented and so that the set resolution matches the mounting height.

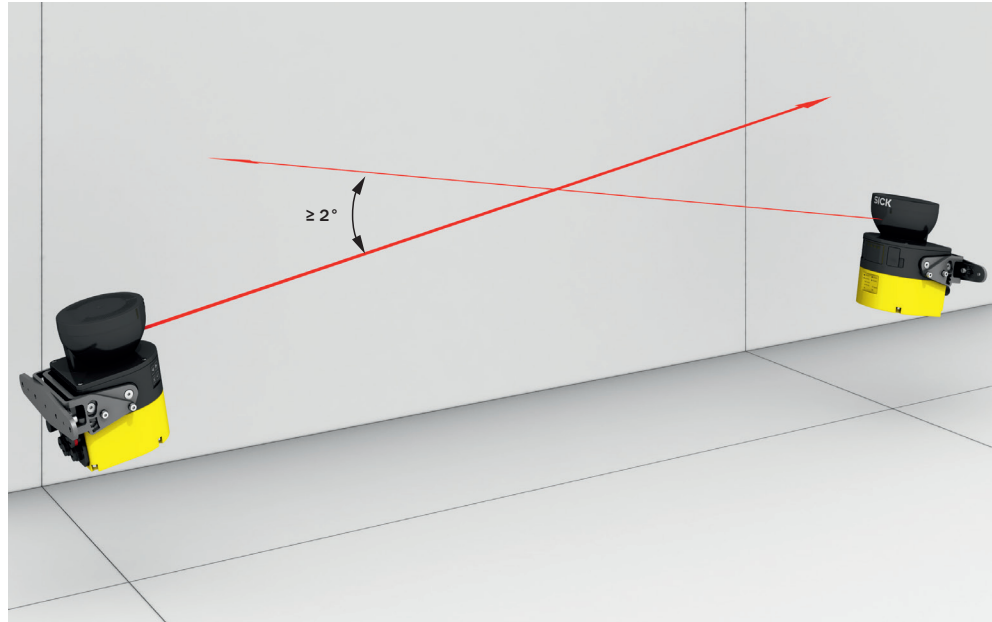

Figure 92: Mounting 2 safety laser scanners opposite one another

If you tilt neighboring safety laser scanners toward one another, the safety laser scanners can be tilted upward or downward.

In any event, ensure that the protective field is at the right height so that crawling beneath and climbing over are prevented and so that the set resolution matches the mounting height.

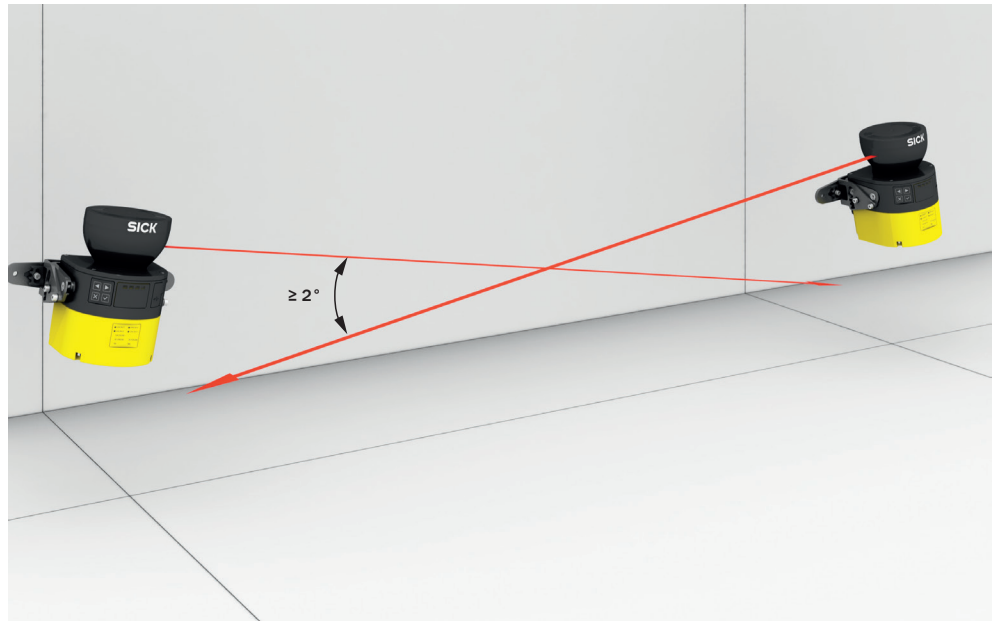

Figure 93: Mounting 2 safety laser scanners next to one another

19 List of figures

1.	Laser class 1M.....	10
2.	SICK product ID.....	13
3.	Device overview.....	13
4.	Principle of time-of-flight measurement.....	14
5.	Light pulses scan an area.....	15
6.	Protective field, shown in red in this document.....	18
7.	Reference contour field, shown in blue-green in this document.....	18
8.	Warning field, shown in yellow or orange in this document.....	19
9.	Field set, consisting of one protective field (red) and 2 warning fields (orange and yellow).....	20
10.	Monitoring case 1 with field set 1.....	20
11.	Monitoring case 2 with field set 2.....	21
12.	Hazardous area protection: detection of the presence of a person in the hazardous area.....	21
13.	Hazardous point protection: Hand detection.....	22
14.	Access protection: detection of a person when accessing a hazardous area.....	22
15.	Mobile hazardous area protection: detection of a person when a vehicle approaches.....	23
16.	Prevent crawling beneath.....	25
17.	Prevent stepping over.....	26
18.	Unsecured areas.....	27
19.	Mounting with deflector plates (example).....	28
20.	Mounting in an undercut (example).....	28
21.	Mounting in vehicle paneling (example).....	29
22.	Overrun of the protective field in front of an opening.....	30
23.	Tolerance band of the contour as reference field (protective field within the protected opening, edge of the protected opening = reference contour).....	31
24.	Stationary application with horizontal scan plane for hazardous area protection.....	33
25.	Protection against reaching over when mounted low (dimensions in mm).....	36
26.	Protection against reaching over when mounted high (dimensions in mm).....	36
27.	Scan plane at ankle height.....	37
28.	Scan plane at calf height.....	38
29.	Distance of the protective field from the wall.....	39
30.	Stationary application in vertical operation for hazardous point protection.....	40
31.	Stationary application in vertical operation for access protection.....	43
32.	Mobile application in horizontal operation for hazardous area protection.....	46
33.	flat-rate supplement ZF for lack of ground clearance.....	47
34.	Minimum supplement for lack of ground clearance.....	48
35.	Stopping distance as a function of the vehicle's speed.....	49
36.	Recommended fitting height.....	51
37.	Recommended fitting height for inverted mounting.....	51
38.	Dual-channel and separate connection of the OSSDs of an OSSD pair.....	54
39.	No potential difference between load and protective device.....	55
40.	How the restart interlock works (1): no one in protective field, machine operates.....	59
41.	How the restart interlock works (2): person detected in protective field, safety output in OFF state.....	59
42.	How the restart interlock works (3): person in hazardous area, no detection in protective field, safety output still in OFF state.....	60
43.	How the restart interlock works (4): the reset pushbutton must be pressed before restarting the machine.....	60
44.	Electrical diagram of external device monitoring (EDM).....	61
45.	Prevent crawling beneath.....	67
46.	Prevent stepping over.....	67

47. Mounting the safety laser scanner directly.....68

48. Connection of the OSSDs of an OSSD pair..... 70

49. No potential difference between load and protective device 70

50. Pin assignment of the connecting cable (male connector, M12, 8-pin, A-coded). 71

51. Software controls.....74

52. Configuration.....77

53. Overview..... 79

54. Functional scope.....81

55. Identification..... 82

56. Application..... 83

57. Monitoring plane.....85

58. Reference contour field..... 90

59. Field editor..... 92

60. Field set template..... 95

61. Background image.....97

62. Editing fields using coordinates.....98

63. Area that cannot be monitored.....99

64. Enable propose field..... 100

65. Inputs and outputs, local..... 102

66. Monitoring cases..... 106

67. Simulation.....110

68. Report..... 113

69. Alignment about the transverse axis..... 120

70. Alignment about the depth axis..... 120

71. Status LEDs..... 121

72. LEDs..... 122

73. Status LEDs..... 123

74. Fixing screws for the optics cover.....128

75. Installing the system plug on the safety laser scanner..... 132

76. Pushbuttons on the device..... 133

77. Error display..... 135

78. Data recorder.....137

79. Event history..... 139

80. Message history..... 141

81. Switch-off tests..... 152

82. Duration and time offset for the switch-off tests in an OSSD pair.....152

83. Scanning range and object size for warning fields (devices with a max. protective field range of 4.0 m and devices with max. protective field range of 5.5 m)..... 154

84. Scanning range and object size for warning fields (devices with a max. protective field range of 9.0 m).....154

85. Scanning range and required remission for warning fields (devices with a max. protective field range of 4.0 m and devices with max. protective field range of 5.5 m).....155

86. Scanning range and required remission for warning fields (devices with a max. protective field range of 9.0 m)..... 156

87. Dimensional drawing.....157

88. Mounting 2 safety laser scanners with the optics cover facing upward.....168

89. Mounting 2 safety laser scanners with the optics cover facing downward..... 168

90. Mounting the upper safety laser scanner with the optics cover facing upward and mounting the lower safety laser scanner with the optics cover facing downward.... 169

91. Mounting the upper safety laser scanner with the optics cover facing downward and mounting the lower safety laser scanner with the optics cover facing upward169

92. Mounting 2 safety laser scanners opposite one another.....170

93. Mounting 2 safety laser scanners next to one another..... 170

20 List of tables

1.	Target groups and selected sections of these operating instructions.....	8
2.	Field types and their function.....	17
3.	Status of the channels of the control inputs with complementary evaluation.....	56
4.	System plug and connections: microScan3 Core.....	71
5.	Pin assignment of the connecting cable with M12 plug connector.....	71
6.	User groups.....	75
7.	User groups.....	75
8.	Recommended multiple sampling.....	87
9.	Buttons on the toolbar.....	92
10.	Colors of the field types.....	93
11.	Buttons for field sets.....	94
12.	Settings for the field editor.....	97
13.	Mask areas.....	99
14.	Defining global field geometry.....	100
15.	Empirical values for the required input delay.....	107
16.	Show/hide preset for specified cutoff behavior.....	109
17.	Starting and stopping safety function.....	112
18.	Buttons.....	117
19.	Status LEDs.....	121
20.	Status LEDs.....	123
21.	Overview of status information.....	123
22.	Error types.....	135
23.	Data recorder.....	138
24.	Print or export message history.....	141
25.	Devices and type codes.....	143
26.	Functional scope of the microScan3 Core I/O (devices with a max. protective field range of 4.0 m and devices with max. protective field range of 5.5 m).....	143
27.	Functional scope of the microScan3 Core I/O (devices with a max. protective field range of 9.0 m).....	143
28.	Revision.....	144
29.	Compatibility.....	144
30.	Features.....	144
31.	Safety-related parameters.....	146
32.	Interfaces.....	146
33.	Electrical data.....	147
34.	Mechanical data.....	149
35.	Ambient data.....	149
36.	Miscellaneous data.....	150
37.	Response time of an individual safety laser scanner.....	151
38.	Protective field range (devices with a max. protective field range of 4.0 m).....	153
39.	Protective field range (devices with a max. protective field range of 5.5 m).....	153
40.	Protective field range (devices with a max. protective field range of 9.0 m).....	153
41.	microScan3 Core I/O ordering information.....	158
42.	Safety laser scanner without system plug.....	159
43.	System plug.....	159
44.	Additional spare parts.....	159
45.	Note on standards.....	165

Australia

Phone +61 (3) 9457 0600
1800 33 48 02 – tollfree
E-Mail sales@sick.com.au

Austria

Phone +43 (0) 2236 62288-0
E-Mail office@sick.at

Belgium/Luxembourg

Phone +32 (0) 2 466 55 66
E-Mail info@sick.be

Brazil

Phone +55 11 3215-4900
E-Mail comercial@sick.com.br

Canada

Phone +1 905.771.1444
E-Mail cs.canada@sick.com

Czech Republic

Phone +420 234 719 500
E-Mail sick@sick.cz

Chile

Phone +56 (2) 2274 7430
E-Mail chile@sick.com

China

Phone +86 20 2882 3600
E-Mail info.china@sick.net.cn

Denmark

Phone +45 45 82 64 00
E-Mail sick@sick.dk

Finland

Phone +358-9-25 15 800
E-Mail sick@sick.fi

France

Phone +33 1 64 62 35 00
E-Mail info@sick.fr

Germany

Phone +49 (0) 2 11 53 010
E-Mail info@sick.de

Greece

Phone +30 210 6825100
E-Mail office@sick.com.gr

Hong Kong

Phone +852 2153 6300
E-Mail ghk@sick.com.hk

Hungary

Phone +36 1 371 2680
E-Mail erteakesites@sick.hu

India

Phone +91-22-6119 8900
E-Mail info@sick-india.com

Israel

Phone +972 97110 11
E-Mail info@sick-sensors.com

Italy

Phone +39 02 27 43 41
E-Mail info@sick.it

Japan

Phone +81 3 5309 2112
E-Mail support@sick.jp

Malaysia

Phone +603-8080 7425
E-Mail enquiry.my@sick.com

Mexico

Phone +52 (472) 748 9451
E-Mail mexico@sick.com

Netherlands

Phone +31 (0) 30 204 40 00
E-Mail info@sick.nl

New Zealand

Phone +64 9 415 0459
0800 222 278 – tollfree
E-Mail sales@sick.co.nz

Norway

Phone +47 67 81 50 00
E-Mail sick@sick.no

Poland

Phone +48 22 539 41 00
E-Mail info@sick.pl

Romania

Phone +40 356-17 11 20
E-Mail office@sick.ro

Singapore

Phone +65 6744 3732
E-Mail sales.gsg@sick.com

Slovakia

Phone +421 482 901 201
E-Mail mail@sick-sk.sk

Slovenia

Phone +386 591 78849
E-Mail office@sick.si

South Africa

Phone +27 10 060 0550
E-Mail info@sickautomation.co.za

South Korea

Phone +82 2 786 6321/4
E-Mail infokorea@sick.com

Spain

Phone +34 93 480 31 00
E-Mail info@sick.es

Sweden

Phone +46 10 110 10 00
E-Mail info@sick.se

Switzerland

Phone +41 41 619 29 39
E-Mail contact@sick.ch

Taiwan

Phone +886-2-2375-6288
E-Mail sales@sick.com.tw

Thailand

Phone +66 2 645 0009
E-Mail marcom.th@sick.com

Turkey

Phone +90 (216) 528 50 00
E-Mail info@sick.com.tr

United Arab Emirates

Phone +971 (0) 4 88 65 878
E-Mail contact@sick.ae

United Kingdom

Phone +44 (0)17278 31121
E-Mail info@sick.co.uk

USA

Phone +1 800.325.7425
E-Mail info@sick.com

Vietnam

Phone +65 6744 3732
E-Mail sales.gsg@sick.com

Detailed addresses and further locations at www.sick.com

