



# RFU65x

## QUICKSTART

en

### 1 About this document

The purpose of this Quickstart is to allow you to commission the RFU65x RFID read/write device (UHF) quickly and easily and to achieve initial read results with transponders.

The Quickstart is valid for the regional variants listed in the "Device overview" section: [see Device overview, page 6](#)

In the following, the Quickstart refers to the RFU650-101xx read/write device simply as "device". If variants are to be differentiated in the regional assignment, the respective device name RFU650-101xx is specified (xx = regional assignment).

The Quickstart describes the commissioning process for an application with a single device. This applies to the ambient temperature range of 0 °C to +60 °C.

Commissioning is done using the example of device variant RFU650-10100 (region Europe/South Africa), based on the default of the device. The optional CDB650-204 connection module handles the industrial-standard signal distribution for the device. Other connection modules are available.

All rights reserved. Subject to change without notice.

#### Supplementary and other relevant documents

More information, such as application examples and downloads of associated documents and associated software, can be found on the SICK product page on the Internet at: [www.sick.com/RFU65x](http://www.sick.com/RFU65x)

Information about configuration of the device can be found in the online help function of the SOPAS ET configuration software and the "RFU parameter description" technical information.

#### Operating the RFU650 in a fieldbus with line topology

The optional incorporation of the device in the PROFIBUS or PROFINET fieldbus is described in the relevant operating instructions for the CDF600-21xx or CDF600-2200 fieldbus module, [see RFU650 read/write device, page 6](#).

### 2 Safety information

- This chapter is dedicated to the safety of commissioning personnel and the operator of the system in which the device is integrated.
- Read this Quickstart carefully to familiarize yourself with the device and its functions before commissioning the device. The Quickstart is considered a part of the device and must be kept in an accessible location in the immediate vicinity of the device at all times!
- For country-specific particulars to consider when operating the device, [see Operational restrictions, page 6](#).

#### ⚠ WARNING

##### Health hazard as a result of high-frequency electromagnetic radiation!

The RFU650-10100 (Europa/South Africa region) is designed for operation in accordance with ETSI EN 302208. During operation, the human exposure regulations covered by EN 50364 must be observed.

- Limit human exposure to electromagnetic fields. Suitable safety distances must be maintained during both short-term and long-term work in the radiation range of the integrated antenna.

Minimum distances to be maintained between the antenna and the human body during long-term transmission according to ETSI:

- 30 cm at maximum antenna radiation power of 2 W ERP
- 15 cm at radiation power of 0.5 W ERP

The RFU650-10101 (region: USA/Canada/Mexico) satisfies the limit values of the FCC for exposure to radiation in an uncontrolled environment.

- During operation, a safety distance of at least 30 cm must be maintained between the antenna and the human body.

- To comply with the IP67 enclosure rating in operation, the following requirements must be met. If this is not done, the device does not fulfill any specified IP enclosure rating.
  - The side cover for both the USB female connector and the microSD card slot must be screwed tight to the device. Recommended tightening torque for the cover screws: 40 Ncm ± 5 Ncm.
  - The SICK cables plugged into the M12 connections must be screwed tight.
  - Any electrical connections that are not being used must be fitted with protective caps or plugs that are screwed tight (as in the delivery condition).
  - Only operate the device without a cover for a short period while inserting or removing the memory card or temporarily using the USB interface. During this time, protect the device against moisture and dust.

- Opening the screws of the device housing will invalidate any warranty claims against SICK AG. For further warranty provisions, see the General Terms and Conditions of SICK AG, e.g. on the delivery note of the device.

#### 📌 NOTE

SICK uses standard IP technology in its products. The emphasis is placed on availability of products and services.

SICK always assumes the following prerequisites:

- The customer ensures the integrity and confidentiality of the data and rights affected by its own use of the aforementioned products.
- In all cases, the customer implements the appropriate security measures, such as network separation, firewalls, virus protection, and patch management.

### 2.1 Intended use

The RFU650 read/write device is an intelligent SICK 4Dpro sensor from the RFU65x product family. The stationary device automatically identifies wireless-based data cards (transponders) on stationary and moving objects. The device offers passage and direction detection for moving transponders. The device also supports data card management.

As a compact read/write device, the device features an internal antenna. The antenna is integrated into the housing. The device processes all standard passive transponders in accordance with ISO/IEC 18000-6C and EPCglobal UHF C1G2 in the regional UHF carrier frequency range. Intelligent process logic enables processing either as a stand-alone solution or as part of a group in a network. The device sends the read results to a higher-level computer via its host interface. The computer coordinates further processing.

Intended use also includes compliance with all information in this Quickstart.

### 3 Mounting

#### 3.1 Scope of delivery

- Device in the version ordered (region assignment). Electrical connections fitted with protective caps or plugs. Without connecting cables and brackets.
- Regional printed Quickstarts. Included language versions: [see Device overview, page 6](#).
- Other language versions may be available in PDF format on the device product page on the Internet at: [www.sick.com/RFU65x](http://www.sick.com/RFU65x).

#### 3.2 Equipment required

- 4 x M6 screws or 3 x M5 screws for mounting the device on a mounting device (bracket) provided by the user. The screw length required depends on the mounting base (wall thickness of the bracket).
- When using an optional SICK bracket: The screws for mounting the device on the bracket are included with delivery of the bracket.

#### 3.3 Mounting requirements

- The permissible ambient conditions for operating the device must be observed, e.g. assigned region, ambient temperature, [see Technical data \(excerpt\), page 5](#) and ground potential [see Electrical installation, page 2](#).
- The device must be mounted using all 4 M6 or 3 M5 blind tapped holes provided, [see Device layout, page 4](#).
- Use stable mounting equipment with sufficient load-bearing capacity and appropriate dimensions for the device. Weight (with cables): [see Technical data \(excerpt\), page 5](#) and dimensions: [see Device layout, page 4](#).
- Avoid the use of electrically conductive material between transponder and device.

#### 3.4 Mounting the device

- Select a suitable mounting location for the device. The mounting location and position depend on the antenna fields of the device and the transponders used.
- Optional: Attached separately ordered SICK mounting accessories to the device. Otherwise, mount the device to the bracket supplied by the user using appropriate screws. Observe the maximum screw-in depth of the blind hole thread here, [see Device layout, page 4](#).
- Align the surface of the internal antenna of the device (front face) to the data card on the object. While doing so, take into account the shape, alignment, and dimensions of the antenna fields. Avoid as far as possible any large metal surfaces positioned to the front. If this is not possible, do not mount the antenna(s) plane parallel with the surface.

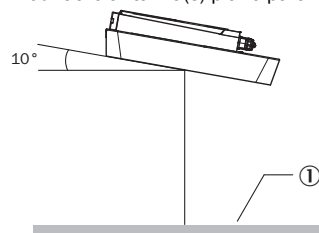

Figure 1: Select the approach angle of the antenna with large frontal metal surface, e. g. 10°

① Metal surface

- For the read or write process, make sure that there are no interference factors, such as electrically conductive material (e.g. liquids) or persons, between the device and transponder. These factors could dampen or reflect the generated UHF field and thereby reduce the sensing range.

### Sensing range of the reading and writing field

The environment can influence the UHF field or antenna, making it impossible to provide a "clear" demarcation of the sensing range. Application-specific reflections can result in both overreaches and "holes". For estimation purposes, the device can also output diagnostic data that provides an indication of the read and write quality in addition to the read results. This data can be used to achieve optimum read results when setting up the system.

The quality of the transponder and the material of the object (plastic, wood, metal) also determine the sensing range.

The quality of the transponder is determined by:

- Antenna gain
- The integrated transponder chip and the related sensitivity, and the reflected energy

The radiation pattern shown here for the internal antenna of the device was obtained in a reproducible environment (absorber chamber) for illustrative purposes. The diagram may therefore only have limited applicability to your specific application.

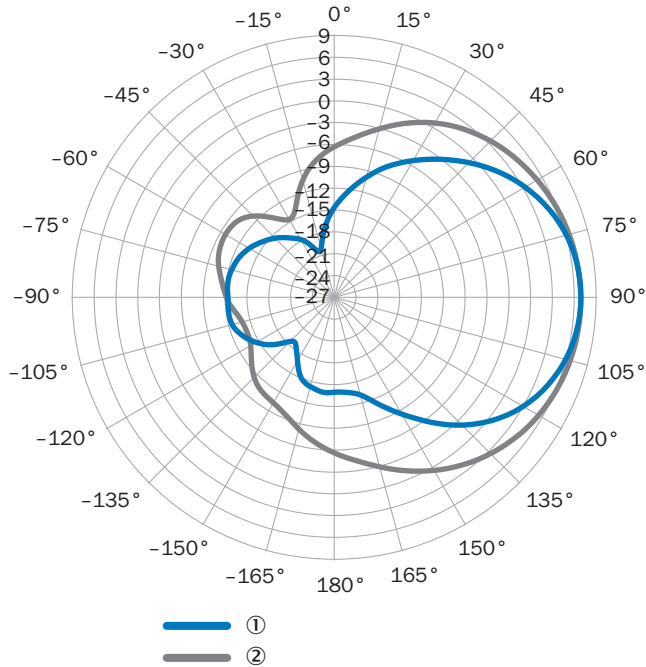

Figure 2: Radiation pattern of the internal antenna of the RFU650 (typical): Measured antenna gain in dBic at 866.5 MHz, RHCP (right-hand circularly polarized)

- ① Horizontal plane (azimuth)
- ② Vertical plane (elevation)

### 3.5 Mounting the CDB650-204 connection module

- ▶ Mount the CDB650-204 connection module in the vicinity of the device. When using the serial data interfaces (RS-232), the recommended length of cable between the devices is max. 5 m. Mount the CDB650-204 in such a way that the device can be accessed at all times, see the CDB650-204 connection module operating instructions.

## 4 Electrical installation

- The electrical installation must only be performed by electrically qualified persons.
- Standard safety requirements must be met when working on electrical systems.
- Electrical connections between the RFU650 and other devices may only be made or separated when there is no power to the system. Otherwise, there is a risk of damaging the devices.
- In the case of open end connecting or extension cables, make sure that bare wire ends do not touch. This creates a risk of short-circuits if the supply voltage is switched on. Wires must be appropriately insulated from each other.
- The wire cross-sections in the supply cable from the user's power system must be selected in accordance with the applicable national standards.
- All circuits connected to the device must be designed as SELV circuits.

### Supply voltage

- Supply voltage DC 18 V to 30 V:
  - When the device is connected to the optional SICK CDB650-204 or CDM420-0006 connection module using a SICK cable.
  - When the device is operated without a connection module using a SICK cable. 2 A fuse protection at the start of the feeding supply circuit.
- Optional 12 V to 30 V DC supply voltage when the device is operated without a connection module using SICK supply cable part no. 6048319 (2 x 2.5 mm<sup>2</sup>, 10 m). 2.5 A fuse protection.
- The voltage supply via a power supply unit must be capable of buffering a brief power failure of 20 ms.
- The voltage supply or power supply unit must satisfy SELV requirements in accordance with the currently applicable EN 60950-1. (SELV = Safety Extra Low Voltage).

### Required input voltage on connection module

Voltage drops in the supply circuit affect the connection cable from the connection module (CDB650-204 or CDM420-0006) to the device (decrease dependent on the length) as well as – to a certain extent – the connection module itself. In order to compensate for this loss when operating the device at the lower end of

the supply range (18 V DC), the following, higher input voltage must be applied to the connection module:

### Cable-dependent input voltages

Cable part no.	6052286	6051194	6051195
Length of cable	2 m	3 m	5 m
CDB650-204 input voltage	19.0 V	19.5 V	20.3 V
Device input voltage	18.0 V	18.0 V	18.0 V
Cable voltage drop	1.0 V	1.5 V	2.3 V

- 1) Wire cross-section for supply voltage: 0.14 mm<sup>2</sup>, AWG 25/26

### ⚠ WARNING

#### Risk of injury and damage caused by electrical current!

As a result of equipotential bonding currents between the device and other grounded devices in the system, faulty grounding of the device can give rise to the following dangers and faults:

- Dangerous voltages are applied to the metal housings.
- Devices will behave incorrectly or be destroyed.
- Cable shielding will be damaged by overheating and cause cable fires.

#### Remedial measures

- Only skilled electricians should be permitted to carry out work on the electrical system.
- If the cable insulation is damaged, disconnect the voltage supply immediately and have the damage repaired.
- Ensure that the ground potential is the same at all grounding points.
- Where local conditions do not meet the requirements for a safe earthing method, take appropriate measures (e.g., ensuring low-impedance and current-carrying equipotential bonding).

For measures for eliminating hazards, see the "Electrical installation" chapter in the RFU63x/65x RFID read/write device (UHF) operating instructions in the Internet at: [www.sick.com/RFU65x](http://www.sick.com/RFU65x).

### ! NOTICE

#### Risk of damage to the device due to possible short-circuit!

The supply voltage input for the device is designed with internal circuit protection to provide reverse polarity protection. The internal functional earth, which also corresponds to the negative pole of the supply voltage for the device, is connected directly to the metal housing of the device due to reasons relating to high frequency.

If the supply voltage is polarity-reversed, this will not cause any damage provided that the following conditions are met for the device:

The device is not connected in an electrically conductive manner, either via other cables or via its housing, to other peripheral devices which use the same reference potential.

### 📌 NOTE

The USB interface of the device is used in industrial environments only as a service interface for temporary use (e.g. for configuration, troubleshooting). Permanent use in real operation of the system as a host interface is not intended.

### Connecting the device

1. Connect the communication interface (e.g., Ethernet) of the device directly to the PC.  
Commissioning: Electrical connection block diagram of the RFU650-101 xx with optional connection module: **A**
2. Connect the male connector of the "Power/Serial Data/CAN/I/O" connection via a suitable cable (e.g. part no. 6052286, 2 m) to the female connector of the CDB650-204.
3. If necessary, connect a read cycle trigger sensor, such as a photoelectric retro-reflective sensor, to the "Sens/IN 1" switching input of the CDB650-204.
4. Depending on the length of the connecting cable, supply the device with DC voltage between 18 V and 30 V.  
✓ After successful initialization, the "Device Ready" LED lights up green.
5. Turn on the PC and start Windows.

Block diagram of all interfaces of the RFU65 x-101 xx together with the optional connection module: **B**

### Power/Serial data/CAN/I/O connection

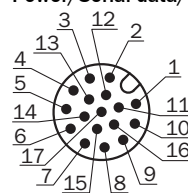

Figure 3: Male connector, M12, 17-pin, A-coding

### Pin assignment of the "Power/Serial data/CAN/I/O" connection (M12)

Pin	Signal	Function
1	GND	Ground
2	V <sub>s</sub>	Supply voltage
3	CAN L	CAN bus (IN/OUT)

Pin	Signal	Function
4	CAN H	CAN bus (IN/OUT)
5	TD+ (RS-422/485), Host	Host interface (sender+)
6	TD- (RS-422/485), Host TxD (RS-232), Host	Host interface (sender-)
7	TxD (RS-232), Aux	Aux interface (sender)
8	RxD (RS-232), Aux	Aux interface (receiver)
9	SensGND	Digital input ground
10	Sensor 1	Digital input 1
11	RD+ (RS-422/485), Host	Host interface (receiver+)
12	RD- (RS-422/485), Host RxD (RS-232), Host	Host interface (receiver-)
13	Result 1	Digital output 1
14	Result 2	Digital output 2
15	Sensor 2	Digital input 2
16	N.c.	-
17	N.c.	-
-	-	Screen

### M12 adapter cable on D-Sub, e.g. part no. 2055419 (2 m)

Adapter cable (female connector, M12, 17-pin, A-coded/male connector, D-Sub-HD, 15-pin)

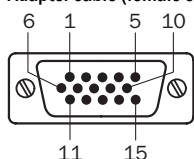

Figure 4: Male connector, D-Sub-HD, 15-pin

Pin assignment of the "Power/Serial data/CAN/I/O" connection (D-Sub-HD)

Pin	Signal	Function
1	V <sub>s</sub>	Supply voltage
2	RxD (RS-232), Aux	Aux interface (receiver)
3	TxD (RS-232), Aux	Aux interface (sender)
4	Sensor 2	Digital input 2
5	GND	Ground
6	RD+ (RS-422/485), Host	Host interface (receiver+)
7	RD- (RS-422/485), Host RxD (RS-232), Host	Host interface (receiver-)
8	TD+ (RS-422/485), Host	Host interface (sender+)
9	TD- (RS-422/485), Host TxD (RS-232), Host	Host interface (sender-)
10	CAN H	CAN bus (IN/OUT)
11	CAN L	CAN bus (IN/OUT)
12	Result 1	Digital output 1
13	Result 2	Digital output 2
14	Sensor 1	Digital input 1
15	SensGND	Digital input ground

### Ethernet connection

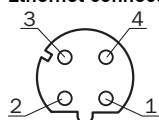

Figure 5: M12 female connector, 4-pin, D-coded

Pin assignment of the "Ethernet" connection

Pin	Signal	Function
1	TD+	Sender+
2	RD+	Receiver+
3	TD-	Sender-
4	RD-	Receiver-

## 5 Commissioning and configuration with PC (Windows)

Adjustment of the device parameters to the application as well as diagnostics in the event of malfunctions is undertaken by default with the SOPAS ET configuration software.

### 5.1 Installing and starting the configuration software

- Download and install the latest version of the SOPAS ET configuration software as well as the current device description files (\*.sdc): [www.sick.com/SOPAS\\_ET](http://www.sick.com/SOPAS_ET). In this case, select the "Complete" option as suggested by the installation wizard. Administrator rights may be required on the PC to install the software.
- Start the "SOPAS ET" program option after completing the installation. Path: Start > Programs > SICK > SOPAS ET Engineering Tool > SOPAS.
- Establish communication between SOPAS ET and device with the automatically launching wizard. To do so, select the RFU650 under the devices available depending on the connected communication interface, e.g. in the Ethernet (default Ethernet address: IP address: 192.168.0.1, subnet mask: 255.255.255.0). SOPAS ET establishes communication with the device and loads the associated device description file. The **Quickstart** tab opens.

### 5.2 Detecting a transponder in Quickstart mode

- Bring one or more standards-compliant UHF transponders into the working range of the internal antenna of the device. The UII/EPC of the individual transponders must be differentiated so that several transponders can be detected.
- Click the **Start** button on the **Quickstart** tab of SOPAS ET. SOPAS ET generates an automated read cycle and lists the detected transponders one after another in the Quickstart window.

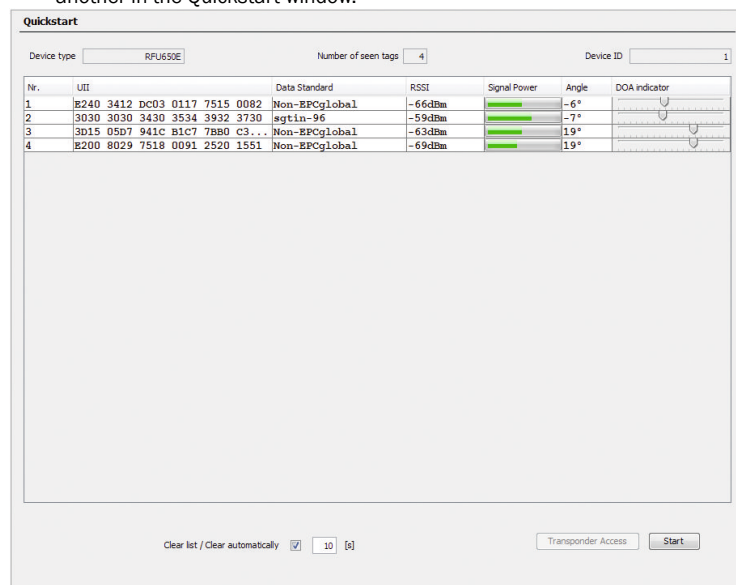



Figure 6: SOPAS ET display of the detected transponders in the Quickstart window

### Feedback about transponder detection in the UHF field

In Quickstart mode, the default signal of the process feedback LED indicates whether a UHF field is present and transponders have been detected. The process feedback LED  is in the center of the device front plate, and in this case, lights up blue.

### Process feedback LED

PF LED	Status	Status
At half brightness		
Lights up	ON	UHF field present
At full brightness		
Flashing	Flashing slowly (f = 1.25 Hz)	1 transponder in field
Flashing	Flashing quickly (f = 2.5 Hz)	2 transponders in field
Flashing	Flashing faster (f = 5 Hz)	More than 2 transponders in field

### NOTE

The automated triggering in Quickstart mode is intended for (initial) commissioning and not for permanent use when operating the device under real conditions.

### 5.3 Accessing the data on a transponder

- In order to access the memory area of a transponder, click the **Stop** button in **Quickstart**.
- Highlight the desired transponder (click it with the mouse).
- Click the **Transponder Access** button. The **Transponder Management Access** tab displays the content of the selected transponder.



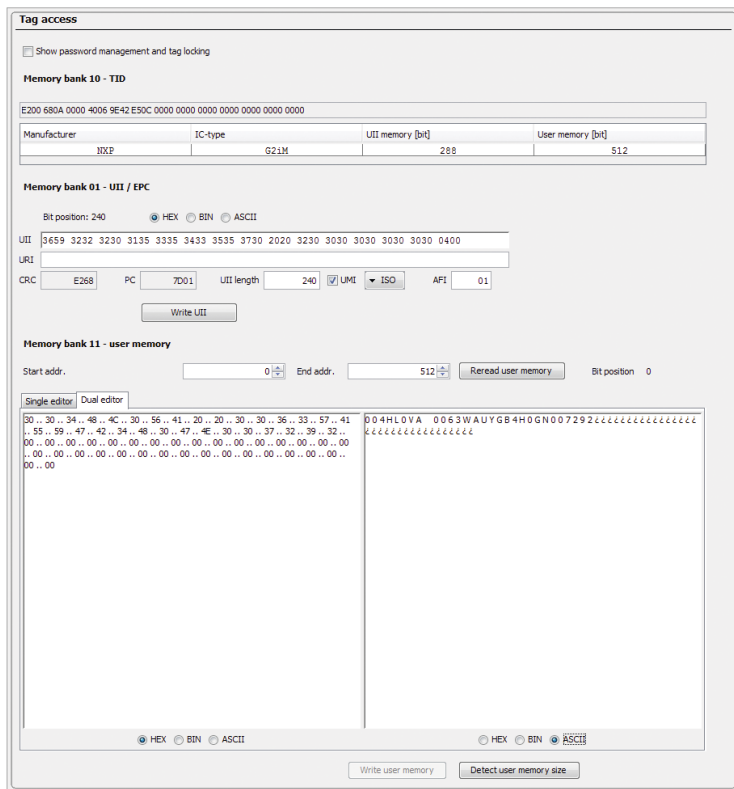

Figure 7: Transponder Access SOPAS ET display window

**NOTE**  
The TID (tag identifier) of the transponder cannot be changed.

### 5.4 Continuing the configuration

- Under SOPAS ET in the left-hand navigation tree, edit the required tabs for the application using the additional entries under **Parameters**. These include antenna configuration, performance optimization, data preprocessing, transponder processing, object trigger control (e. g. via "Sensor 1" digital input), data processing and output, data output interface(s), function of the digital inputs and outputs as well as the possible use of an optional microSD memory card.
- Set the transmitting power for the internal antenna using sliders on the **Antenna Configuration** tab.
  - Regional permissible values for the antenna, see [Device overview, page 6](#).
  - RFU650 transmitting power default: 23 dBm (200 mW)

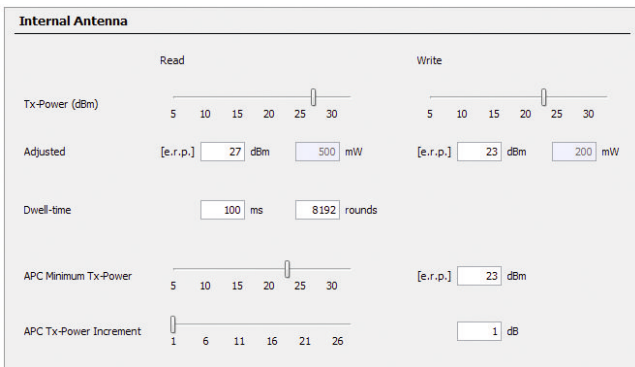

Figure 8: SOPAS ET: Example setting for the internal antenna

- Test and, if necessary, modify the settings made when operating the system under real conditions.

### 5.5 Completing the configuration

- Permanently save the entire configuration once it has been successfully tested:
  - Parameter set in the device: Click the button
  - Configuration file on the PC: Click buttons **Device** > **Export SDV file**.

## 6 Device description

### 6.1 Device layout

Dimensional drawing of the RFU650, all dimensions in mm or inch:

### 6.2 Status displays

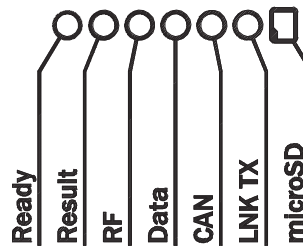

Figure 9: Status indicators on the first display level

#### Status displays

Advertisement	LED	Color	Status
Ready	Lights up	Green	Device ready
	Lights up	Red	Hardware error
	Flashing	Green	Flashing cyclically 4 x red, 1 x green in PROFINET operation (single port): Trying to establish a connection to a PLC (IO controller) or loss of connection during operation
	Flashing	Red	
Result	Lights up	Green	Read or write successful
RF	Lights up	Green	UHF field activated
	Lights up	Red	Internal antenna fault / HF part
Data	Lights up	Green	Data output via host interface
CAN	Lights up	Yellow	Data traffic via CAN bus (CAN Rx)
LNK TX	Lights up	Green	Data traffic via Ethernet
microSD	Lights up	Green	MicroSD memory card inserted and ready for operation. In this state, the device can either read data from the card or write data to the card. If the LED lights up, however, this does not indicate that the device is accessing the card!
	Lights up	Red	MicroSD memory card inserted; however, it cannot be read or is defective
	Lights up	Yellow	Over SOPAS ET a function is started manually, which requires a memory card; however, the microSD memory card is not ready for operation (e.g., not plugged in, contacts contaminated, or without free storage space for writing).

#### Additional indicators for ambient temperatures below -20 °C

Display	LED	Color	Status
Ready	Flashing	Yellow	Flashing, frequency 1 Hz. The device is not ready for use. Temperature of the device under -25 °C.
	Flashing	Green	Flashing, frequency 1 Hz. The device is not ready for use. Temperature of the device between -25 °C and -20 °C. After an approx. 2 min warm-up phase, the device starts regular operation.

#### Audible status indicator (beeper)

Default: 1 sound when at least one transponder is in the UHF field

### 6.3 microSD memory card (optional accessory)

#### Function

The device can execute the following functions on the plug-in memory card:

- Automated, additional storage of the internal parameter set to an external storage medium (cloning function), if available. This is done in the framework of the recommended safety concept for the 4Dpro device parameter sets. The function is triggered by saving the internal parameter set with the "permanent" option. The function is used, among other things, to conveniently transmit the parameter set to an exchange unit of the same type in the event of an error. Optional external media include a memory card which can be plugged into the device or the CMC600 parameter storage module, which can be used in the optional connection module, e.g., CDB650-204 or CDM420-0006.
- Continuous recording of diagnostic read data after the first manual start, e.g., via SOPAS ET. Recording is resumed after a device restart when the function is set permanently.

The first time a parameter set is stored, we recommend that an empty memory card is used (if necessary, check and delete the contents of the card on the PC using a card reader).

The memory card is not included with delivery.

Only use types approved by SICK to ensure reliable function of the memory card, see [www.sick.com/RFU65x](http://www.sick.com/RFU65x). The memory card has no write protection that can be activated.

#### Inserting the memory card

**NOTE**  
To avoid damaging the memory card, make sure there is no power to the device when you insert or remove it.

The card slot can be accessed on the device behind the aluminum cover, see [Device description, page 4](#).

Maintaining enclosure rating IP67: see [Safety information, page 1](#).

1. Switch off the supply voltage to the device.
2. To remove the cover, unscrew both Allen screws (A/F 2).
3. Making sure it is in the correct position (with the contacts pointing to the front and down – see the symbol on the device), insert the memory card into the card slot until it locks into place.
4. Screw the aluminum cover back on. Recommended tightening torque for the cover screws: 40 Ncm ± 5 Ncm.
5. Switch the supply voltage for the device back on.

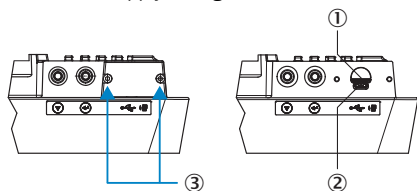

Figure 10: USB connection and slot for microSD memory card

- ① Slot for microSD memory card
- ② USB port (female connector, Micro-B, 5-pin)
- ③ 2 x screw, (Allen screw, A/F 2 mm)

6. Once it is switched on, the device automatically detects the presence of a memory card and, depending on the card's content, behaves as follows:
  - If the card is empty or if it contains a parameter set that cannot be interpreted by the device, the device saves its currently valid internal parameter set to the card (provided there is sufficient storage space) and starts with the internal parameter set.
  - If the card contains a parameter set that can be interpreted by the device, the device overwrites the currently valid internal parameter set with this external parameter set.  
The goal is for the internal parameter set and the parameter set saved externally to always be identical.

### ! NOTICE

#### Possible data loss or irreparable damage to the memory card!

The “microSD” LED lights up green when a memory card which is ready for operation is inserted into the device. In this state, the device can either read data from the card or write data to the card. Access to the card itself is not signaled by the device (compare electronic camera with memory card).

The “microSD” LED lights up yellow when, for example, a function which requires a memory card has been started manually with SOPAS ET and the card is not ready for operation (e.g., not inserted, contacts are contaminated, or no free storage space).

- ▶ To avoid damaging the memory card, make sure there is no power to the device when you insert or remove it.
- ▶ If parameter values are changed with the “permanent” option in the device using the SOPAS ET configuration software while the memory card is inserted or if functions are started which access the memory card (e.g., logging of data), do not remove the memory card and do not switch off the supply voltage.
- ▶ In order to remove the memory card in a controlled manner while working with SOPAS ET when the device is switched on, select the **Remove SD card** function under **Analysis/SD card** and wait for confirmation from SOPAS ET.

## 7 Maintenance and care

The device does not contain components that require maintenance.

- ▶ If it is contaminated (e.g., metal dust), clean the antenna hood of the device carefully using a soft, damp cloth (with a mild cleaning agent) in order to achieve the full read and write speed. The antenna hood is made of plastic.

## 8 Transport and storage

Transport and store the device in the original packaging, with protective plugs and caps completely screwed-on. Do not store outdoors. To ensure that any residual moisture present can escape, do not store the device in airtight containers. Do not expose to any aggressive substances.

Storage conditions: Dry, dust-free, no direct sunlight, as little vibration as possible, storage temperature –30 °C to +70 °C, relative humidity max. 90% (non-condensing).

## 9 Repairs

Repair work on the device may only be performed by qualified and authorized service personnel from SICK AG.

## 10 Disassembly and disposal

Any device which can no longer be used must be disposed of in an environmentally friendly manner in accordance with the applicable country-specific waste disposal regulations. As it is categorized as electronic waste, the device must never be disposed of with household waste!

## 11 Technical data (excerpt)

Technical specifications

Type	RFU650-101xx
Regional assignment	Depending on type: <a href="#">see Device overview, page 6</a>
Firmware version	Depending on type: <a href="#">see Device overview, page 6</a>

Type	RFU650-101xx
Carrier frequency	Depending on type: <a href="#">see Device overview, page 6</a>
Transmitting power	Internal antenna, adjustable: depending on type, <a href="#">see Device overview, page 6</a>
Internal antenna	Circular polarized, 80°/55° aperture angle, typical front-to-back ratio of > 15 dB
Air interface protocol	ISO/IEC 18000-6C EPCglobal UHF Class 1 Generation 2
Sensing range	≤ 10 m (depending on the transponder and ambient conditions)
Serial RS-232/RS-422/RS-485	Host 1 (0.3 kBd ... 115.2 kBd) for data output
Serial RS-232	Aux 1 (57.6 kBd) for servicing <sup>1)</sup>
USB <sup>2)</sup>	Aux 3 (USB 2.0) for servicing <sup>1)</sup>
CAN	CAN (CANopen®), 20 kBit/s ... 1 MBit/s. Max. bus length 30 m
Ethernet	10/100 Mbit/s <ul style="list-style-type: none"> <li>• Host 2 (TCP/IP, Ethernet-IP, PROFINET (Single Port) for Firmware V1.65) for data output</li> <li>• AUX 2 (TCP/IP, Ethernet-IP) for servicing<sup>1)</sup></li> <li>• Services: DHCP, NTP, HTTP, mDNS, DNS-SD</li> </ul>
PROFIBUS	Host over external CDF600-21xx module
PROFINET (line topology)	Host over external CDF600-2200 module
Digital inputs	2 x physical, 2 x additional external via optional CMC600 module in the CDB650-204 or CDM420-0006 connection module. $V_{in} = \max. 30 V$ , $I_{in} = \max. 5 mA$ opto-decoupled, reverse polarity protected, debounce time can be set.
Digital outputs	2 x physical, 2 x additional external via optional CMC600 module in the CDB650-204 or CDM420-0006 connection module. $V_{out} = V_s - 1.5 V$ , $I_{out} \leq 100 mA$ (typical). Short-circuit protected, temperature protected, not electrically isolated from the supply voltage
Electrical connections	<ul style="list-style-type: none"> <li>• 1 x male connector, M12, 17-pin, A-coded</li> <li>• 1 x female connectors, M12, 4-pin, A-coded</li> <li>• 1 x female connector, USB, 5-pin, Micro B type</li> </ul>
Optical indicators	<ul style="list-style-type: none"> <li>• 7 x RGB LED (status indicators) on front top</li> <li>• 1 x RGB LED (process feedback) in front center, function/color can be adjusted via SOPAS ET</li> </ul>
Acoustic indicator	Beeper, can be deactivated, can be allocated function for event signaling via SOPAS ET
Function key	2 x, select and start/stop functions
Parametric data backup	Optional: via plug-in microSD card or externally via the CMC600 module in the CDB650-204 or CDM420-0006 connection module
Supply voltage $V_s$	SELV in accordance with currently applicable standard EN 60950-1. UL-certified devices require a supply voltage in accordance with SELV - LPS according to UL/IEC/EN60950-1 or class 2 according to NEC, UL1310. DC 18 V ... 30 V when connected to CDB650-204 or CDM420-0006 connection modules and when operated without a SICK connection module. Always when using a SICK cable, <a href="#">see Electrical installation, page 2</a> .
Power consumption	Standby: 6 W typical At full transmitting power: <ul style="list-style-type: none"> <li>• Typically &lt; 20 W (with no loading of switching outputs)</li> <li>• Max. 26 W (with a typical loading of the 2 switching outputs of 100 mA each and a 30 V DC supply voltage).</li> </ul>
Housing/weight	Aluminum/approx. 4.3 kg
Safety	EN 60950-1: 2006-04/A11: 2009-03/A1: 2010-03/A12: 2011-02
Electrical protection class	III (EN 61140: 2006-08)
Enclosure rating	IP 67 (EN 60529: 1991-10/A2:2000-02)
Radio equipment approval	See model-specific online data sheet
EMC	EN 301489-3
MTBF	25 years <sup>3)</sup>
Vibration resistance Shock resistance	EN 60068-2-6: 2008-02 EN 60068-2-27: 2009-05
Ambient temperature range	Operation: –25 °C (–30 °C <sup>4)</sup> ) ... +60 °C Storage: –30 °C ... +70 °C
Relative humidity	0 % ... 90 % Non-condensing
Conformity	CE, UL <sup>5)</sup>
Clock	NTP network time protocol, no internal clock

- 1) For example: configuration, diagnosis, transponder access or display of read results
- 2) Interface only for temporary use.
- 3) Continuous operation at an ambient operating temperature of +50 °C.
- 4) For firmware version V2.02 or higher.
- 5) Only UL certified if the type label contains the UL logo.

For further technical specifications, see the online data sheet on the product page on the Internet at: [www.sick.com/RFU65x](http://www.sick.com/RFU65x).

## Regulatory notes

### Europe: Simplified EU declaration of conformity

SICK AG hereby declares that the RFU650-101xx radio equipment complies with the 2014/53/EU directive. The complete text of the EU declaration of conformity is available at the following web address: [www.sick.com/RFU65x](http://www.sick.com/RFU65x).

## 12 Device overview

RFU65x-101xx: Device overview

Regional assignment	Firmware version	Carrier frequency range	Transmitting power of the internal antenna	Device type	Part no.	Supplied Quickstart (Part no.)
Europe/South Africa	V1.65	865.7 MHz ... 867.5 MHz	Max. 1.6 W (ERP <sup>1)</sup> )	RFU650-10100	1073556	English (8018808), German (8018807)
USA/Canada/Mexico	V1.65	902.75 MHz ... 927.25 MHz	Max. 2.5 W (EIRP <sup>2)</sup> )	RFU650-10101	1076522	English (8018808), French (8018809), Spanish (8018810)
Australia	2.0.0 R	920.25 MHz ... 925.75 MHz	Max. 2 W (EIRP <sup>2)</sup> )	RFU650-10102	1087587	English (8018808)
India	V2.10	865.70 MHz... 866.90 MHz	Max. 1.6 W (ERP <sup>1)</sup> )	RFU650-10103	1096413	English (8018808)
Brazil	2.0.0 R	902.75 MHz... 907.25 MHz... 915.25 MHz... 927.25 MHz	Max. 2.5 W (EIRP <sup>2)</sup> )	RFU650-10104	1092036	English (8018808), Portuguese (801881)
China	V1.67	920.625 MHz ... 924.375 MHz	Max. 1.6 W (ERP <sup>1)</sup> )	RFU650-10105	1083559	English (8018808), Chinese (8018813)
Japan	V1.67	916.8 MHz ... 920.4 MHz	Max. 2.5 W (EIRP <sup>2)</sup> )	RFU650-10106	1083560	English (8018808), Japanese (8018814)

1) ERP = equivalent radiated power.

2) EIRP = equivalent isotropic radiated power.

### 12.1 Operational restrictions

#### ! NOTICE

##### Operational restrictions!

When delivered, the frequency band of the RFU650 is configured in such a way that it can be operated in the following assigned regions (depending on the model) without interfering with protected frequencies (such as mobile communications):

- RFU650-10100 (Europe/South Africa)
- RFU650-10101 (USA/Canada/Mexico)
- RFU650-10102 (Australia)
- RFU650-10103 (India)
- RFU650-10104 (Brazil)
- RFU650-10105 (China)
- RFU650-10106 (Japan)

Operating the same RFU650 in other regions can interfere with protected frequencies.

- ▶ Only use the RFU650 in the region for which it has been approved.
- ▶ When reselling the RFU650, inform the buyer of the regional assignment.

#### France

The RFU650 must not be operated within a 20 km radius of 13 military zones.

#### Lithuania

There may be restrictions in Lithuania (extent not currently known).

#### Russia

Only licensed operation is possible in Russia.

#### USA

(1) This device complies with part 15 of the FCC Rules. Operation is subject to the following two conditions:

(1) This device may not cause harmful interference, and (2) this device must accept any interference received, including interference that may cause undesired operation.

(2) Changes or modifications not expressly approved by the party responsible for compliance could void the user's authority to operate the equipment.

(3) Note: This equipment has been tested and found to comply with the limits for a Class A digital device, pursuant to part 15 of the FCC Rules. These limits are designed to provide reasonable protection against harmful interference when the

equipment is operated in a commercial environment. This equipment generates, uses, and can radiate radio frequency energy and, if not installed and used in accordance with the instruction manual, may cause harmful interference to radio communications. Operation of this equipment in a residential area is likely to cause harmful interference in which case the user will be required to correct the interference at his own expense.

(4) To comply with FCC part 15 rules in the United States, the system must be professionally installed to ensure compliance with the Part 15 certification.

(5) It is the responsibility of the operator and professional installer to ensure that only certified systems are deployed in the United States. The use of the system in any other combination (such as co-located antennas transmitting the same information) is expressly forbidden.

(6) This device complies with the limit values defined by the FCC for radio radiation in an uncontrolled environment. The device must have a minimum distance of 30 cm between the source of radiation and your body.

#### Canada

(1) This Class A digital apparatus complies with Canadian ICES-003.

(2) This device satisfies the Industry Canada CNR applicable to license-free radio equipment. Use is permitted providing the two following conditions are met: (1) The device must not cause any faults and (2) the user of the device must accept any fault produced in the device, even if this may impair its function.

#### Mexico

(1) IFETEL note:

"Operation is subject to the following two conditions: (1) This device must not produce any harmful faults and (2) this device must be able to withstand faults, including faults that may cause unwanted operating behavior."

## 13 Sources for obtaining more information

Additional information about the device, its optional accessories, and fieldbus modules can be found in electronic format on the following product pages on the Internet at:

### 13.1 RFU650 read/write device

You can obtain the Quickstart, operating instructions and additional documentation, for accessories as well, from the Internet at [www.sick.com](http://www.sick.com):

- Enter the device's type designation or part number into the search field.
- Select the desired device.
  - All documentation and other downloadable content relating to the device can be found under **Downloads**.
  - Under **Software**, you can download function blocks for connecting to an PLC as well as sdd files of the device for the SOPAS ET configuration software.
  - Documentation for usable accessories can be downloaded from **Accessories**.

Configuration software SOPAS ET can be found at: [www.sick.com/SOPAS\\_ET](http://www.sick.com/SOPAS_ET)

### 13.2 Function blocks

[www.sick.com/RFU65x](http://www.sick.com/RFU65x)

- Function blocks for communication between the device and a programmable control from Siemens, Rockwell, or Mitsubishi.
- Function blocks for other controllers on request.

### 13.3 CDF600-21xx PROFIBUS fieldbus module

[www.sick.com/CDF600-2](http://www.sick.com/CDF600-2)

- CDF600-21 xx PROFIBUS fieldbus module operating instructions in English (no. 8015335) and German (no. 8015334), in other languages if required

### 13.4 CDF600-22xx PROFINET fieldbus module

[www.sick.com/CDF600-2](http://www.sick.com/CDF600-2)

- CDF600-2200 PROFINET fieldbus module operating instructions (M12 variant) in English (no. 8015922) and German (no. 8015921) as well as in other languages, if applicable

### 13.5 Documents on request

- Overview of command strings of the device

Support is also available from your sales partner: [www.sick.com](http://www.sick.com)

### 13.6 Copyright notices

#### Open source programs

SICK uses open-source software in the device. This software is licensed by the rights holders using the following licenses among others: the free licenses GNU General Public License (GPL Version2, GPL Version3) and GNU Lesser General Public License (LGPL), the MIT license, zLib license, and the licenses derived from the BSD license.

This program is provided for general use, but WITHOUT ANY WARRANTY OF ANY KIND. This warranty disclaimer also extends to the implicit assurance of marketability or suitability of the program for a particular purpose.

More details can be found in the GNU General Public License.

View the complete license texts here: [www.sick.com/licensesetexts](http://www.sick.com/licensesetexts)

Printed copies of the license texts are also available on request.

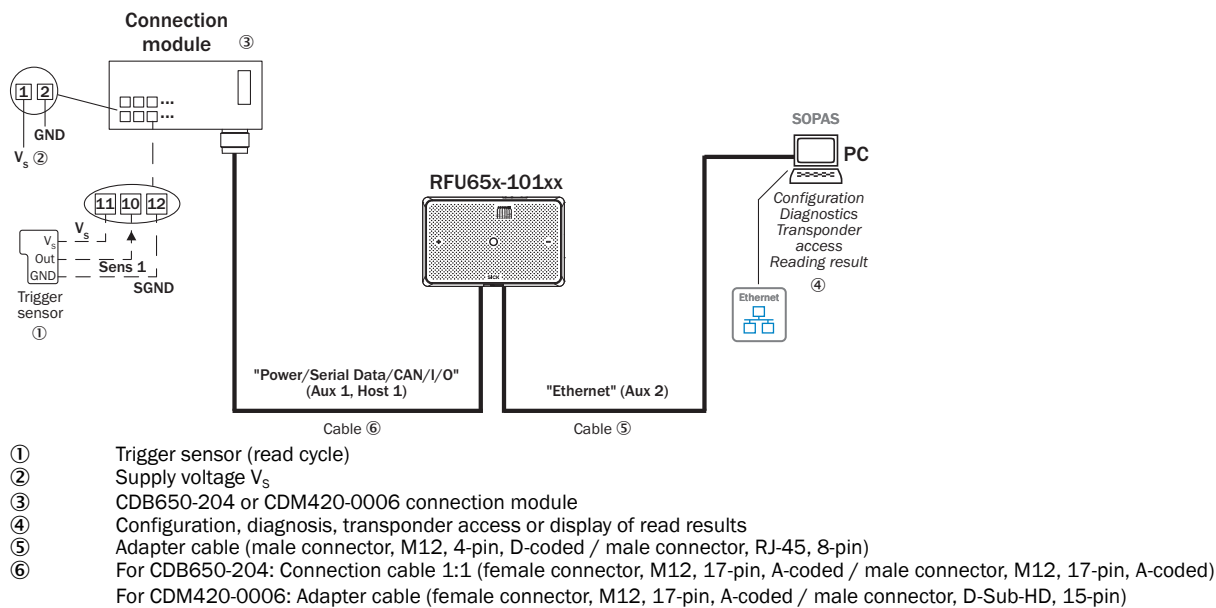
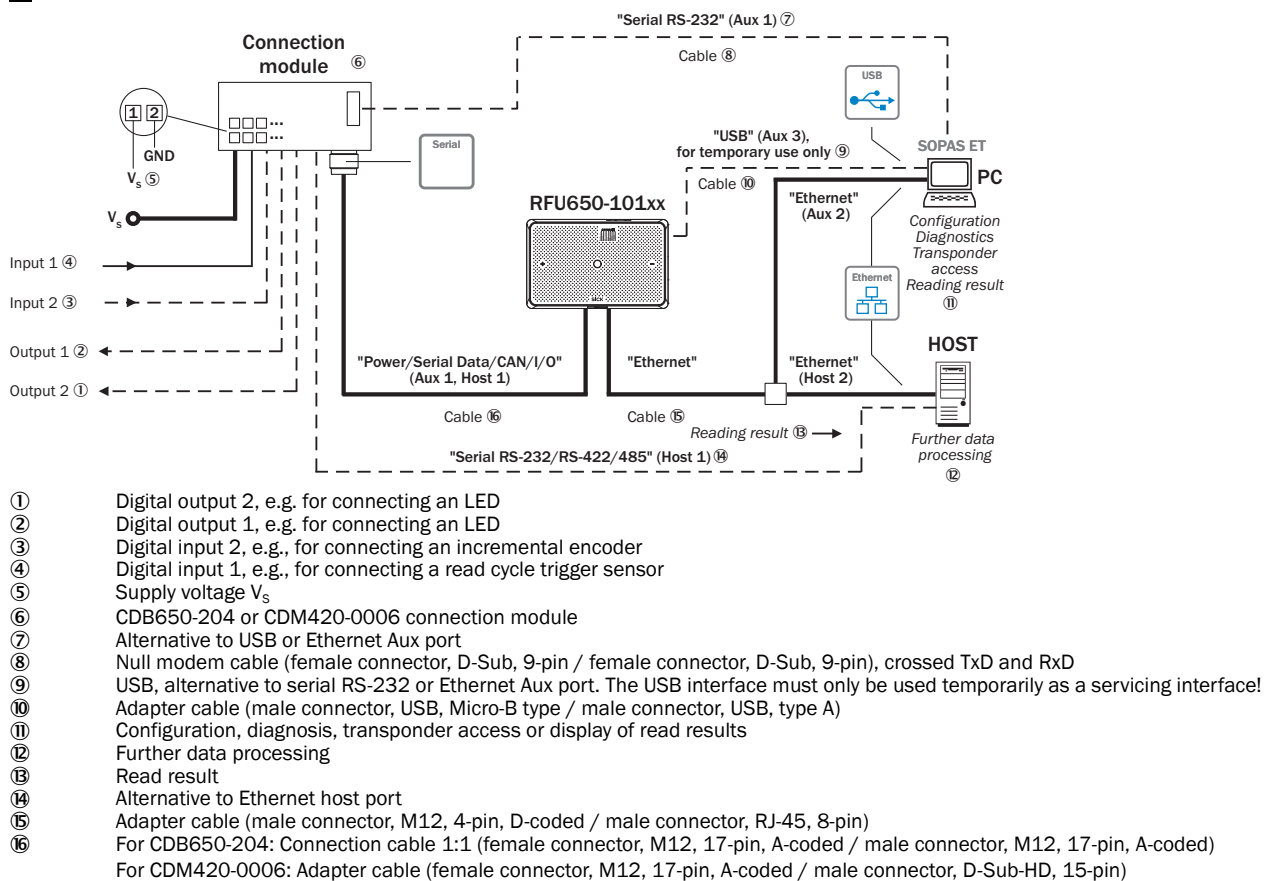
**A****B**

**C**

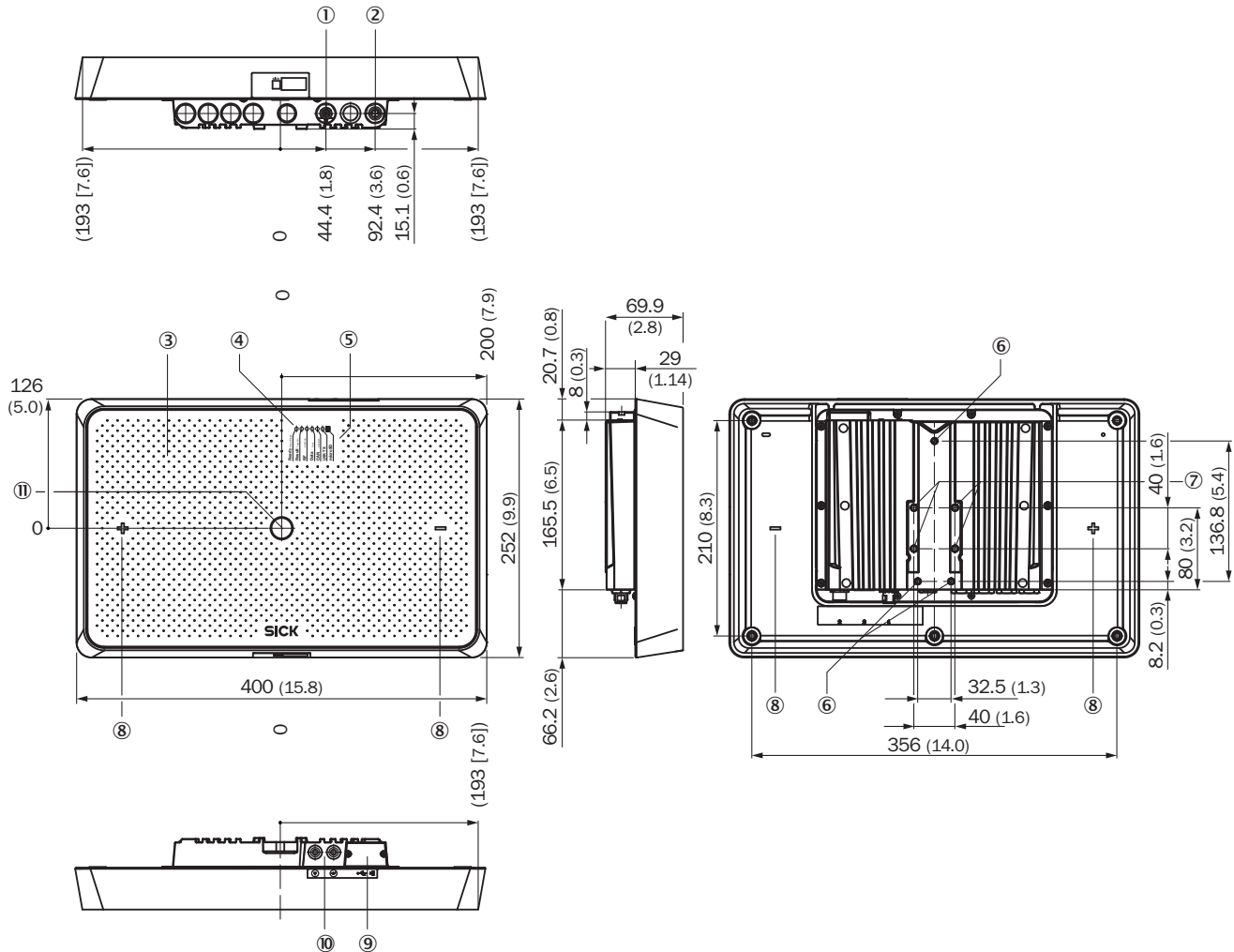

- ① "Power/Serial Data/CAN/I/O" connection (male connector, M12, 17-pin, A-coded)
- ② "Ethernet" connection (female connector, M12, 4-pin, D-coded)
- ③ Cover with internal antenna
- ④ 7 x LED, multi-colored (status indicator)
- ⑤ Acoustic opening of the beeper, under a cover film
- ⑥ 3 x M5 blind tapped hole, 8 mm deep, for mounting the device
- ⑦ 4 x M6 blind tapped hole, 11 mm deep, for alternative mounting of the device
- ⑧ Range definition for angle measurement of the transponders within this working range
- ⑨ "USB" connection (female connector, 5-pin, type Micro-B) and slot for microSD memory card, behind screw-mounted cover. USB interface only for temporary use (servicing).
- ⑩ 2 x function buttons (Step ▼ and Enter ◀)
- ⑪ 1 x LED, multi-colored (process feedback)