



OL1

OPERATING INSTRUCTIONS

en

1 About this document

The operating instructions are used to put the product into operation quickly and easily to get the first measurement results.

1.1 Supplementary and other relevant documents

- AOD1 Quick Start Guide, see www.sick.com/8019684
- AOD1 operating instructions, see www.sick.com/8020327

Additional information (e.g. application examples, other documents, associated software) can be found at www.sick.com/OL1.

2 Safety information

2.1 Intended use

The optical OL1 micrometer is used for optical, non-contact thickness measurement and position determination.

The device can only be used in conjunction with the AOD1 evaluation unit. Up to two sets of OL1 measurement sensors can be configured and controlled with the evaluation unit.

SICK AG assumes no liability for losses or damage arising from the use of the product, either directly or indirectly. This applies in particular to use of the product that does not conform to its intended purpose and is not described in this documentation.

2.2 Improper use

Any use outside of the stated areas, in particular use outside of the technical specifications and the requirements for intended use, will be deemed to be incorrect use.

- The device does not constitute a safety component in accordance with the respective applicable safety standards for machines.
- The device must not be used in explosion-hazardous areas, in corrosive environments or under extreme environmental conditions.
- Any use of accessories not specifically approved by SICK AG is at your own risk.

⚠ WARNING

Danger due to improper use!

Any improper use can result in dangerous situations.

Therefore, observe the following information:

- Product should be used only in accordance with its intended use.
- All information in these operating instructions must be strictly observed.
- Shut down the product immediately in case of damage.

2.3 Internet protocol (IP) technology

📌 NOTE

SICK uses standard IP technology in its products. The emphasis is placed on availability of products and services.

SICK always assumes the following prerequisites:

- The customer ensures the integrity and confidentiality of the data and rights affected by its own use of the aforementioned products.
- In all cases, the customer implements the appropriate security measures, such as network separation, firewalls, virus protection, and patch management.

2.4 Limitation of liability

Relevant standards and regulations, the latest technological developments, and our many years of knowledge and experience have all been taken into account when compiling the data and information contained in these operating instructions. The manufacturer accepts no liability for damage caused by:

- Non-adherence to the product documentation (e.g., operating instructions)
- Incorrect use
- Use of untrained staff
- Unauthorized conversions or repair
- Technical modifications
- Use of unauthorized spare parts, consumables, and accessories

With special variants, where optional extras have been ordered, or owing to the latest technical changes, the actual scope of delivery may vary from the features and illustrations shown here.

2.5 Modifications and conversions

⚠ NOTICE

Modifications and conversions to the device may result in unforeseeable dangers.

Interrupting or modifying the device or SICK software will invalidate any warranty claims against SICK AG. This applies in particular to opening the housing, even as part of mounting and electrical installation.

2.6 Requirements for skilled persons and operating personnel

⚠ WARNING

Risk of injury due to insufficient training.

Improper handling of the device may result in considerable personal injury and material damage.

- All work must only ever be carried out by the stipulated persons.

This product documentation refers to the following qualification requirements for the various activities associated with the device:

- **Instructed personnel** have been briefed by the operator about the tasks assigned to them and about potential dangers arising from improper action.
- **Skilled personnel** have the specialist training, skills, and experience, as well as knowledge of the relevant regulations, to be able to perform tasks delegated to them and to detect and avoid any potential dangers independently.
- **Electricians** have the specialist training, skills, and experience, as well as knowledge of the relevant standards and provisions, to be able to carry out work on electrical systems and to detect and avoid any potential dangers independently. The electrician must comply with the provisions of the locally applicable work safety regulation.

The following qualifications are required for various activities:

Activities and technical requirements

Activities	Qualification
Mounting, maintenance	<ul style="list-style-type: none"> • Basic practical technical training • Knowledge of the current safety regulations in the workplace
Electrical installation, device replacement	<ul style="list-style-type: none"> • Practical electrical training • Knowledge of current electrical safety regulations • Knowledge of the operation and control of the devices in their particular application
Commissioning, configuration	<ul style="list-style-type: none"> • Basic knowledge of the computer operating system used • Basic knowledge of the design and setup of the described connections and interfaces • Basic knowledge of data transmission
Operation of the device for the particular application	<ul style="list-style-type: none"> • Knowledge of the operation and control of the devices in their particular application • Knowledge of the software and hardware environment for the particular application

2.7 Operational safety and particular hazards

Please observe the safety notes and the warnings listed here and in other chapters of this product documentation to reduce the possibility of risks to health and avoid dangerous situations.

⚠ CAUTION

Optical radiation: Laser class 1

The accessible radiation does not pose a danger when viewed directly for up to 100 seconds. It may pose a danger to the eyes and skin in the event of incorrect use.

- Do not open the housing. Opening the housing may increase the level of risk.
- Current national regulations regarding laser protection must be observed.

Caution – Use of controls or adjustments or performance of procedures other than those specified herein may result in hazardous radiation exposure.

⚠ WARNING

Electrical voltage!

Electrical voltage can cause severe injury or death.

- Work on electrical systems must only be performed by qualified electricians.
- The power supply must be disconnected when attaching and detaching electrical connections.
- The product must only be connected to a voltage supply as set out in the requirements in the operating instructions.
- National and regional regulations must be complied with.
- Safety requirements relating to work on electrical systems must be complied with.

⚠ WARNING

Risk of injury and damage caused by potential equalization currents!

Improper grounding can lead to dangerous equipotential bonding currents, which may in turn lead to dangerous voltages on metallic surfaces, such as the housing. Electrical voltage can cause severe injury or death.

- Work on electrical systems must only be performed by qualified electricians.
- Follow the notes in the operating instructions.
- Install the grounding for the product and the system in accordance with national and regional regulations.

3 Commissioning

Ensure that installation is done by a qualified person.

3.1 Scope of delivery

- OL1 in the version ordered
- Y-cable for connecting the OL1 sender and OL1 receiver
- Printed operating instructions (this document)
- Printed Safety Notes, multilingual (brief information and general safety notes)

3.2 Mounting

1. Ensure that the device is not connected to a voltage supply.
2. Mount the AOD1 on the mounting rail.
3. Mount the OL1 over the fixing holes.
4. Align sensor heads in relation to the reference surfaces so that both top sides and both side surfaces lie in the same plane.

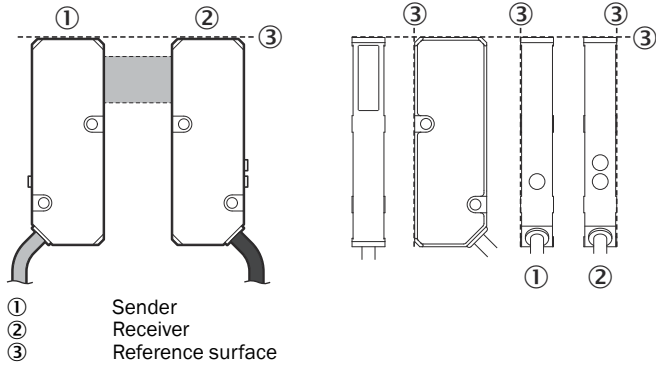

3.3 Alignment of sender - receiver ("direction checking")

The receiver has two alignment LEDs to correctly assembly and align the sensor heads. To use the alignment LEDs, activate the *Direction Checking* function in the AOD1 menu.

1. Keep pressing ∇ until an arrow appears in front of Head 1 or 2 (depending on where the OL1 is connected).
 2. To access the *Top Menu*, press A .
 3. To select *Setup mode*, press Δ .
 4. To display *Direction Checking*, press \leftarrow .
 5. To select *ON*, press ∇ .
 6. Complete with A .
- ✓ *ON* is bracketed.
 - ✓ The alignment LEDs are flashing.
7. Align sensor heads so that both LEDs light up, but do not flash.
 - If no LED lights up on the receiver: Align sensor heads to one another.
 - When the red LED flashes: Move receiver upwards until both LEDs light up.
 - When the green LED flashes: Move receiver downwards until both LEDs light up.

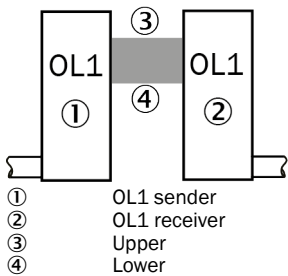

8. After alignment, quit *Direction Checking*: Click on ∇ , select *Off* and confirm with A .
9. To return to the main screen, hold B .

4 Electrical installation

1. Connect OL1 sensor heads without voltage to the AOD1 with the supplied Y-cable.

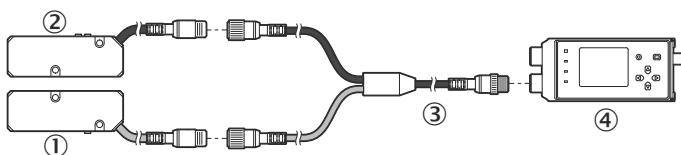

1. Connect AOD1 to the voltage supply (see AOD1 Quickstart).

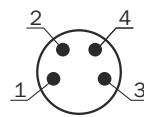

Y-cable connection diagram to AOD1, M8, 4-pin

Pin	Description	Color
1	Vcc	Brown
2	B (RS-485)	White
3	0 V	Blue
4	A (RS-485)	Black

5 Device description

Dimensions

Dimensions: A

OL1E status LEDs (receiver)

Name	Color	Description
Power	Green	<ul style="list-style-type: none"> • Lights up: Supply voltage on • Flashing: Device is in <i>Direction checking mode (Direction checking)</i>
Alarm	Red	<ul style="list-style-type: none"> • Lights up: Device displaying an alarm • Flashing: Device is in <i>Direction checking mode (Direction checking)</i>

AOD1 device display and OL1

NOTE

See AOD1 Quickstart (no. 8019684) for an exact description of the operating elements and menu structure of the AOD1.

AOD1 advertisement	Schematic image	Description	
9.999 background changes to white		There is no object in the measuring range.	
9.999 background remains black		The object is larger than the measuring range.	
-xxx		The object protrudes into the measuring range from above.	Measure polarity Set in a positive direction
+xxx		The object protrudes from below into the measuring range.	Measure polarity Set in a negative direction
+xxx		The object protrudes from below into the measuring range.	Measure polarity Set in a positive direction
-xxx		The object protrudes from below into the measuring range.	Measure polarity Set in a negative direction

6 OL1 menu

1. Keep pressing ∇ until an arrow appears in front of Head 1 or 2 (depending on where the OL1 is connected).
2. To access the *Top menu*, press A .

Top menu

Number	Function	Parameter	Comment
1	Top Menu	Teach mode	-
		Setup mode	-
		Back	Return to basic screen

6.1 OL1 "Setup mode" configuration menu

1. To access the configuration menu, at the *Top Menu* press Δ .

Adjustment options

Number	Function	Parameter	Comment
1	Sensitivity	Mini Sense	-
		2nd Sense	-

Number	Function	Parameter	Comment
		3rd Sense	-
		4th Sense	-
		Max Sense	-
		Adjusted	Configure via Translucent Teach see OL1 "Teach mode" teach-in menu, page 3
2	Measure polarity	Positive	see "Measure polarity" direction function, page 3
		Negative	
3	Moving averaging	1 to 128	-
4	Zeroing value	-5.000 Up to 9.999 (0.000)	-
5	Measure Type	Edge	-
		Width	-
6	Measure direction	Top	Object comes into light band from above
		Bottom	Object comes into light band from below
7	Direction Checking	OFF	see Alignment of sender - receiver ("direction checking"), page 2
		ON	
8	Reset Settings	Not Reset	-
		Execute by (A)	-

"Measure polarity" direction function

Direction function only works with edge measurement (Edge).

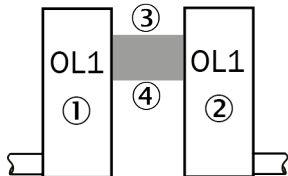

- ① OL1 sender
- ② OL1 receiver
- ③ Upper
- ④ Lower

Use the direction function to configure how the measured values are displayed from the top or bottom (cable side).

Positive: Top -5.000 mm, bottom +5.000 mm
 Negative: Top +5.000 mm, bottom -5.000 mm

6.2 OL1 "Teach mode" teach-in menu

Teach-in option

Number	Function	Comment
1	Zeroing	-
2	Reset Zeroing	-
3	Translucent Teach	Adapts the sensitivity value. Translucent Teach is recommended for semi-transparent materials to improve the detection results. It is only possible to use the Translucent Teach if the sensitivity is set to Adjusted in the Setup mode see OL1 "Setup mode" configuration menu, page 2. The Translucent Teach is run without an object in the measuring range.

7 Application examples

- Keep pressing **(V)** until an arrow appears in front of Head 1 or 2 (depending on where the OL1 is assembled).
- To access the Top Menu, press **(A)**.
- To select Setup mode, press **(Δ)**.
- Press **(◀)** until Measure Type is displayed.
- To select Edge or Width, press **(V)** or **(Δ)**.
- To confirm, press **(A)**.
- To return to the main screen, hold **(B)**.
- To exit the AOD1, Head 1, Head 2 selection mode on the main screen, press **(B)**.

"Edge" detection application

- Measure the edge position relating to the measuring range center of the light band with leading edge detection see AOD1 device display and OL1, page 2.
- When more than one edge is in the measuring range, the device cannot measure and show the value 9.999 (background remains black).

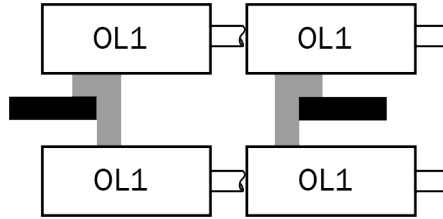

"Edge" detection application for transparent objects

NOTE

Safe edge detection is not guaranteed for very transparent objects (above approx. 80% transmission).

- The function works the same as for edge detection of non-transparent objects.
- The "Adjusted" value must be set in the "Sensitivity" setting for edge detection of transparent objects. For optimal sensitivity adjustment, there must be no measuring object between the sender and the receiver see OL1 "Setup mode" configuration menu, page 2.
- The direction from which the object protrudes into the measuring range must be specified in the "Measure polarity" menu item see "Measure polarity" direction function, page 3.

"Width" and diameter measurement application

- Measures the distance between two edges.
- In this measurement type, the device shows the measured value of 0.000 mm to 9.999 mm.
- The device distinguishes between light-dark and dark-light edges. Then the width function can measure both the width and the gap.
- In "Width" mode, there must always be exactly two edges inside the measuring range. If there are more than two edges inside the measuring range, the output measured values are not specified.
- If there is no or only one edge in the measuring range, the device shows an alarm or "cannot be measured".
- The direction function (Measure polarity) does not work for width measurement.

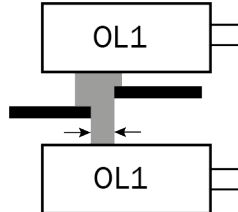

Figure 1: Measurement of the gap between two objects edges

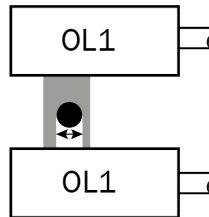

Figure 2: Measurement of object width

8 Cleaning

NOTICE

- Equipment damage due to improper cleaning. Improper cleaning may result in equipment damage.
- Only use recommended cleaning agents and tools.
 - Never use sharp objects for cleaning.

- Clean the front screen at regular intervals and in the event of contamination using a lint-free lens cloth (part no. 4003353) and plastic cleaning agent (part no. 5600006). The cleaning interval essentially depends on the ambient conditions.

9 Technical data

NOTE

The relevant online data sheet for your product, including technical data, dimensional drawing, and connection diagrams can be downloaded, saved, and printed from the Internet:

- www.sick.com/OL1

Please note: This documentation may contain further technical data.

9.1 Mechanics/electronics

Supply voltage V_s	12 V DC ... 24 V DC, $\pm 10\%$, including residual ripple
----------------------	---

Power consumption	< 20 mA (12 V)
Power consumption ¹⁾	Sender: ≤ 0.96 W
	Receiver: ≤ 0.24 W
Warm-up time	≤ 10 min
Housing material	Aluminum die cast
Viewing window material	Glass
Mounting	M3 screws
Connection type	Cable with M8 male connector, 4-pin, length: 30 cm, Y-cable for connecting to the AOD1 evaluation unit
Status indicators ²⁾	Sender 1 status LED: 1 green LED (voltage supply)
	Receiver 2 status LEDs: • 1 green LED (voltage supply) • 1 red LED (alarm)
Weight	Sender: 30 g
	Receiver: 30 g
Dimensions (W x H x D)	9.6 mm x 61 mm x 21 mm
Protection	Reverse polarity protected
Enclosure rating	IP50
Protection class	III

- Without load.
- The LEDs are also used to check that the sender and receiver are aligned correctly, see [Alignment of sender - receiver \("direction checking"\)](#), page 2.

9.2 Performance

Measuring range	10 mm
Mounting distance	0 mm ... 300 mm, sender/receiver
Minimum detectable object	0.2 mm
Repeatability	10 µm
Linearity	± 40 µm
Response time	≥ 0.5 ms
Measuring frequency ¹⁾	≤ 2 kHz

Light sender ²⁾	Laser, red
Laser class	Laser class 1 according to EN/IEC 60825-1:2014. Complies with 21 CFR 1040.10 and 1040.11 except for the listed tolerances in the document "Laser Notice No. 50" of June 24, 2007.
Typ. light spot size (distance)	3 mm x 14 mm
Additional function	Measurement modes: edge detection or diameter/width measurement, configurable average filter, sensitivity adjustment for measuring transparent objects, alignment aid

- The AOD1 does not communicate in sync with the measuring frequency. The AOD1 response after scanning the sensor head is delayed by a maximum of 1.5 ms.
- Wavelength: 660 nm
Max. pulse output: 0.39 W
Max. average power: 0.16 mW
Max. pulse length: 0.5 ms

9.3 Interfaces

Serial	Function: communication with the AOD1 evaluation unit
Digital output ¹⁾	Quantity: 3 Type: PNP/NPN, selectable
Analog output ¹⁾	Quantity: 1 Type: current output Current: 4 mA ... 20 mA, ≤ 300 Ω

- Optionally via the AOD1 evaluation unit.

9.4 Ambient data

Ambient temperature, operation	-10 °C ... +50 °C
Ambient temperature, storage	-20 °C ... +60 °C
Relative humidity (non-condensing)	35% ... 85%
Temperature drift	± 2 µm/K
Vibration resistance	EN 60068-2-6 10 Hz ... 55 Hz (amplitude 1.5 mm, x-, y-, z-axis, 2 hours each)
Shock resistance	EN 60068-2-27 500 m/s ² (x-, y-, z-axis, 3 times each)

- Operating temperature at U_v = 24 V.

