

MARSIC300

Ship Emission Measuring Device

Installation and Initial Start-up

SICK
Sensor Intelligence.



Described product

MARSIC300

Manufacturer

SICK AG
Erwin-Sick-Str. 1
79183 Waldkirch
Germany

Legal information

This work is protected by copyright. Any rights derived from the copyright shall be reserved for SICK AG. Reproduction of this document or parts of this document is only permissible within the limits of the legal determination of Copyright Law. Any modification, abridgment or translation of this document is prohibited without the express written permission of SICK AG.

The trademarks stated in this document are the property of their respective owner.

© SICK AG. All rights reserved.

Original document

This document is an original document of SICK AG.



Contents

1	About this document.....	6
1.1	Function of this document.....	6
1.2	Target group.....	6
1.3	Further information.....	6
1.4	Symbols and document conventions.....	6
1.4.1	Warning symbols.....	6
1.4.2	Warning levels / Signal words.....	7
1.4.3	Information symbols.....	7
2	Installation.....	8
2.1	Gas supply terminology.....	8
2.2	Installation information.....	8
2.2.1	Information on power supply.....	8
2.2.2	Notes on the gas supply.....	8
2.2.3	Tube screw fitting.....	9
2.3	Scope of delivery.....	9
2.4	Provision by operator.....	9
2.5	Installation overview.....	10
2.6	Checklist for mechanical and electrical installation.....	10
2.7	Assembly information for sample gas lines and tube bundle cable.....	11
2.8	Installing the analyzer cabinet.....	13
2.9	Connect the sample gas line to the analyzer.....	14
2.10	Connecting the tube bundle cable to the analyzer.....	16
2.11	Connecting the signal lines to the analyzer.....	19
2.12	Air and gas connections on analyzer.....	20
2.13	Electrical connections on the analyzer.....	23
2.14	Installing the gas sampling system.....	25
2.15	Setting up the Modbus-Profinet converter (optional).....	27
2.16	Setting up the Modbus-Profinet converter (optional).....	32
3	Initial start-up.....	37
4	Configuration software.....	39
4.1	Software SOPAS ET.....	39
4.2	Saving parameters.....	40
4.3	Backing up the logbook with SOPAS ET.....	41
4.4	Passwords.....	41
4.5	Using the menus.....	42
4.6	Menu tree (SOPAS ET).....	42
5	Measuring screens and data storage.....	44
5.1	Measuring screen.....	44
5.2	Data storage function.....	45
6	Parameterization.....	47

6.1	Measuring components.....	47
6.2	Measuring screens.....	47
6.3	Adjustment functions.....	50
	6.3.1.1 Concentrations of test gases.....	51
	6.3.1.2 Adjustment factors.....	51
	6.3.1.3 Start times.....	51
	6.3.1 Manual adjustment.....	52
	6.3.2 Automatic adjustment.....	52
6.4	Measuring point switchover / Sequence control program.....	52
6.5	Data interfaces / IO.....	55
	6.5.1 Digital inputs.....	55
	6.5.2 Digital outputs.....	56
	6.5.3 OPC outputs.....	56
	6.5.4 Modbus.....	56
6.6	Device parameters.....	58
	6.6.1 Temperature control.....	58
	6.6.2 Pressure control.....	59
	6.6.3 Flow rate.....	59
	6.6.4 O2 sensor.....	59
	6.6.5 Logbook.....	59
	6.6.6 Instrument display.....	60
	6.6.7 System	60
	6.6.8 Emitter.....	61
7	Diagnosis.....	62
7.1	Control values adjustment, sensors and signals.....	62
7.2	Sensor values.....	63
7.3	Signals.....	63
7.4	Logbook.....	66
7.5	System info.....	67
	7.5.1 System status.....	68
	7.5.2 System info.....	68
	7.5.3 Timemeter.....	68
8	Maintenance.....	69
8.1	Test digital I/O.....	69
8.2	Setting operating states.....	69
8.3	System maintenance (Stand-by, Leakage test, etc.).....	70
8.4	Restart.....	71
8.5	Service log.....	71
8.6	Acknowledging messages.....	72
8.7	Loading/saving the parameters.....	72
8.8	Loading/saving the parameters after replacing the analyzer.....	73
8.9	Loading/saving the parameters after replacing the electronics.....	74
9	Maintenance.....	75

9.1	Leak tightness check during initial startup.....	75
9.2	Leak tightness check with pressure test tool.....	76
10	Technical data.....	78
10.1	Dimensional drawings.....	78
10.2	Design.....	79
10.3	Measuring parameters.....	79
10.4	Ambient conditions.....	80
10.5	Sample gas conditions.....	80
10.6	Heated sample gas lines.....	81
10.7	Tube bundle cable.....	81
10.8	Interfaces and protocols.....	82
10.9	Power supply.....	82
10.10	Connections in analyzer.....	83
10.11	Circuit breakers.....	86
10.12	Supply gases.....	87
10.13	Tube connections.....	87
10.14	Torques.....	87
11	Annex.....	89
11.1	Gas flow plan.....	89
11.2	Modbus register.....	90
11.2.1	Device status (Discrete Inputs [1xxxx], Function Code 02)...	90
11.2.2	Measured variables (Input Register [3xxxx], Function Code 04).....	90
11.2.3	Device-internal monitoring values (Input Register [3xxxx], Function Code 04).....	91
11.2.4	Triggering the MARSIC 300 (Coils [0xxxx], Function Code 15, write multiple Coils).....	92
11.2.5	VDI 4301 conform range (Holding Register [4xxxx], Function Code 03).....	92
11.3	Error messages and possible causes.....	93
11.4	Tags (variable names).....	100
12	Index.....	102

1 About this document

1.1 Function of this document

This document describes:

- Installation
- Initial start-up
- Operation via SOPAS ET



NOTICE

This technical documentation is only valid in combination with the MARSIC300 Operating Instructions.

1.2 Target group

This document is addressed to technicians (persons with technical understanding) operating and maintaining the measuring system.

The technicians must have been trained on the device.

Requirements for the technician

- The technician must be familiar with the exhaust gas technology on the ship (overpressure, toxic and hot flue gases) and be able to avoid hazards when working on gas ducts.
- The technician must be familiar with handling compressed gas cylinders (test gases).
- The technician must be able to avoid hazards caused by noxious test gases.
- Only allow an authorized electrician to work on the electrical system or electrical subassemblies.

1.3 Further information







- SFU Gas Sampling System Operating Instructions
- Sample Gas Line Operating Instructions
- System documentation
- Short instructions for MARSIC300
- Optional: MPR (Meeting Point Router) Operating Instructions
- Optional: Instrument Air Conditioning Operating Instructions
- Optional: External Measuring Point Switchover Operating Instructions
- Optional: Pressure Test Tool Operating Instructions
- Optional: Profibus/Profinet Converter Operating Instructions
- Optional: HOTSAMPLER (measuring point extension) Operating Instructions

1.4 Symbols and document conventions

1.4.1 Warning symbols

Table 1: Warning symbols

Symbol	Significance
	Hazard (general)
	Hazard by voltage

Symbol	Significance
	Hazard in potentially explosive atmospheres
	Hazard by explosive substances/mixtures
	Hazard by toxic substances
	Hazards by noxious substances
	Hazard by high temperature
	Hazard for the environment/nature/organic life

1.4.2 Warning levels / Signal words

DANGER

Risk or hazardous situation which will result in severe personal injury or death.

WARNING

Risk or hazardous situation which could result in severe personal injury or death.

CAUTION

Hazard or unsafe practice which could result in less severe or minor injuries.

Notice



Hazard which could result in property damage.

Note

Hints

1.4.3 Information symbols

Table 2: Information symbols

Symbol	Significance
	Important technical information for this product
	Important information on electric or electronic functions

2 Installation

2.1 Gas supply terminology

Definition of utility gases:

- Zero gas: Gas to adjust the zero point. Instrument air or nitrogen (N₂)
- Span gas: Gas to adjust the upper measuring range value
- Test gas: Generic term for zero and span gas
- Instrument air: Clean compressed air

Gas quality: [see "Supply gases", page 87](#).

2.2 Installation information

2.2.1 Information on power supply

The operator is responsible for correct laying and connection of the electric lines.



WARNING

Danger to life by electric voltage

- ▶ Only allow an authorized electrician to work on the electric system
-



ATTENTION

The analyzer power supply is configured for an individual power system
Check the configured power system against the system documentation provided.

- ▶ If the analyzer power system does not match the power system on board: Please contact SICK Customer Service.
-

When selecting and laying the electric lines for power supply, observe the applicable local standards and guidelines.

2.2.2 Notes on the gas supply

The operator is responsible for the correct laying of the sample gas lines.



ATTENTION

Risk of contamination of the analyzer by unclean instrument air.

- ▶ Only use instrument air corresponding to the mandatory specification ([see "Technical data", page 78](#)).
 - ▶ Install a suitable instrument air conditioning when necessary.
-

2.2.3 Tube screw fitting

Swagelok screw fitting

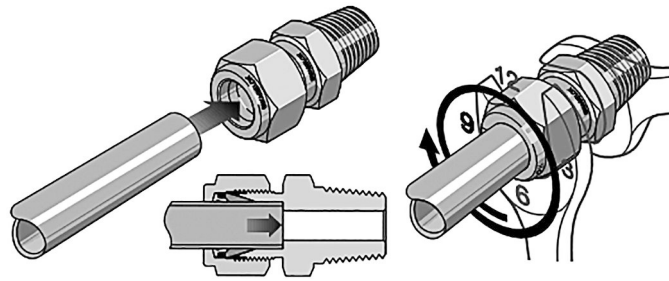

Figure 1: Swagelok screw fitting

- ▶ Push the tube up to the stop in the tube screw fitting. Turn the cap nut finger-tight.
- ▶ During initial assembly: Hold the fitting bolt steady and tighten the cap nut with 1 1/4 revolutions.
- ▶ During refitting: Tighten the cap nut to the previous position (the resistance increases noticeably) and then slightly tighten.

Push-in fitting (pneumatic)

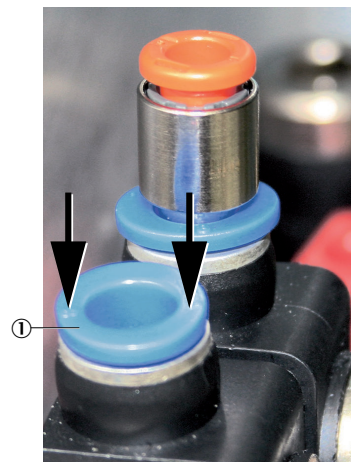

Figure 2: Push-in fitting with retaining ring

- ① Retaining ring
- ▶ Connecting the tube: Push tube in.
- ▶ Disconnecting the tube: Press the retaining ring in and pull the tube out.

It is easier to press the retaining ring in using the pressure tool provided.



Figure 3: Using the pressure tool

Pressure tool

2.3 Scope of delivery

Please see the delivery documents for the scope of delivery.

2.4 Provision by operator

To be provided by operator, especially:

- Suitable flange on the exhaust duct (see “Operating Instructions SFU”)
- Fixing accessories of enclosures (dowels, screws, etc.)

- Fixing accessories for heated sample gas line and tube bundle cable
- Power cable: see "Power supply", page 82
- External power disconnection unit
- Compressed air, instrument air as zero gas when necessary
Observe quality of operator's instrument air: see "Supply gases", page 87
- Optional span gases

2.5 Installation overview

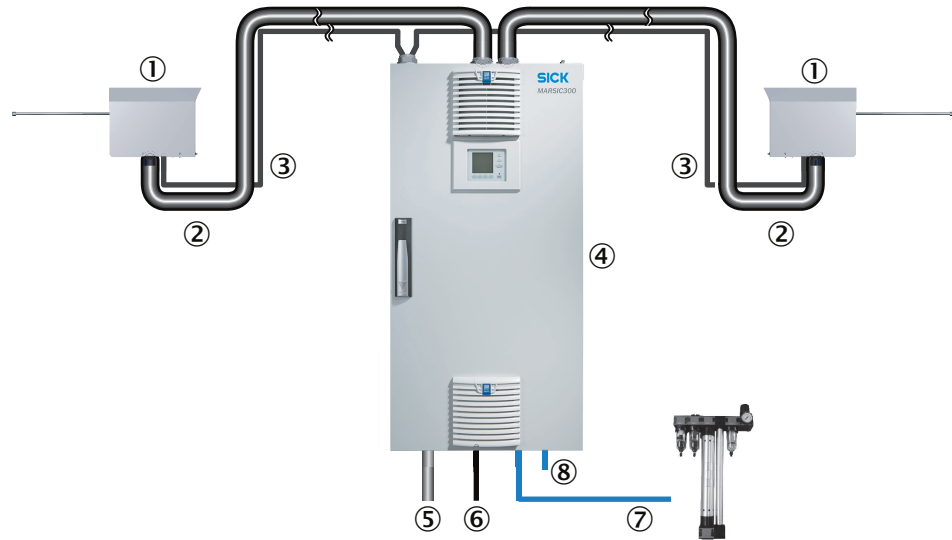

Figure 4: Installation - overview

- ① Gas sampling system
- ② Heated sample gas line (with 2 measuring points: 2 sample gas lines)
- ③ Tube bundle cable (with 2 measuring points: 2 tube bundle cables) with pneumatic and electric lines
- ④ Analyzer
- ⑤ Energy supply
- ⑥ Interfaces
- ⑦ Instrument air inlet
Option: Instrument air conditioning
- ⑧ Sample gas outlet

2.6 Checklist for mechanical and electrical installation



NOTICE

Observe the sequence during installation. Connect the gas sampling units on the exhaust duct as last task.

Incorrect assembly can create a risk of contaminating the gas extraction system. In this case, exhaust gas can penetrate the unheated analyzer and possibly condensate.

1. First connect instrument air and power supply.
2. Then install the gas sampling system in the exhaust duct.

Observe laying information (Chapter see "Assembly information for sample gas lines and tube bundle cable", page 11).

Table 3: Fitting and connecting system components

System component	Reference
Install analyzer cabinet	see "Installing the analyzer cabinet", page 13

System component	Reference
Connect sample gas line to analyzer	see "Connect the sample gas line to the analyzer", page 14
Connect tube bundle cable to analyzer	see "Connecting the tube bundle cable to the analyzer", page 16
Connect signal lines to analyzer	see "Connecting the signal lines to the analyzer", page 19
Air and gas connections on analyzer	see "Air and gas connections on analyzer", page 20
Electrical connections on analyzer	see "Electrical connections on the analyzer", page 23
Install SFU gas sampling system	see "Installing the gas sampling system", page 25
Optional: Configure Modbus-Profinet /Profibus converter	see "Setting up the Modbus-Profinet converter (optional)", page 27
Optional: Install measuring point switchover HOTSAMPLER	See Operating Instructions HOTSAMPLER
Optional: Install MPR	See Operating Instructions MPR

2.7 Assembly information for sample gas lines and tube bundle cable

Installing the sample gas lines



WARNING

Risk of fire

- ▶ Observe the laying instructions provided with the line.
- ▶ Minimum clearance to other lines (for example, tube bundle cable): 10 cm.
- ▶ Do not lay or roll up lines directly next to each other.



WARNING

Danger to life by electric voltage

- ▶ Only allow an authorized electrician to work on the electric system
-
- ▶ Start laying at the analyzer.
 - The end **with** the electric connection belongs on the analyzer.

Important: The screw fitting for the enclosure duct must be located at the end of the electrical connection (analyzer side).
 - The end **without** electrical connection belongs on the gas sampling system.

Roll-up excess length on the gas sampling system.
Leave enough length for pulling the gas sampling system.
 - ▶ Protect the line from damage (chafing through vibration, mechanical load).
 - ▶ Observe minimum bend radius of 300 mm.

Installing the tube bundle cable

Start laying the tube bundle cable at the analyzer and roll-up excess length at the gas sampling probe.

1. Assembly on the analyzer: see "Air and gas connections on analyzer", page 20 and see "Electrical connections on the analyzer", page 23.
2. Lay the tube bundle cable to the analyzer cabinet.
 - Attach excess length to the gas sampling probe.
 - Leave enough length for pulling the probe.
 - Protect the line from damage (chafing through vibration, mechanical load).
 - Minimum bend radius: 300 mm.

3. Assembly on the gas sampling probe: see "Installing the gas sampling system", page 25.



NOTE

Fit the sample gas lines and tube bundle cable on the cable strips with holes.

- ▶ Observe the minimum distance and bend radius.

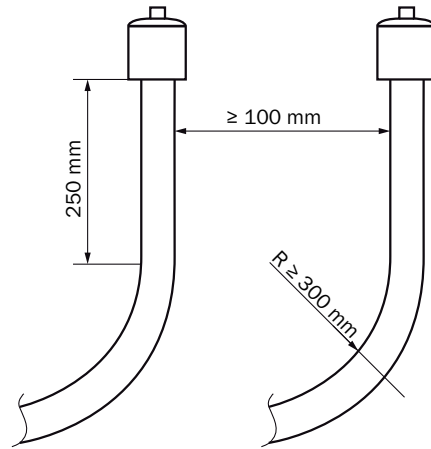

Figure 5: Sample gas line - distance and radius

2.8 Installing the analyzer cabinet

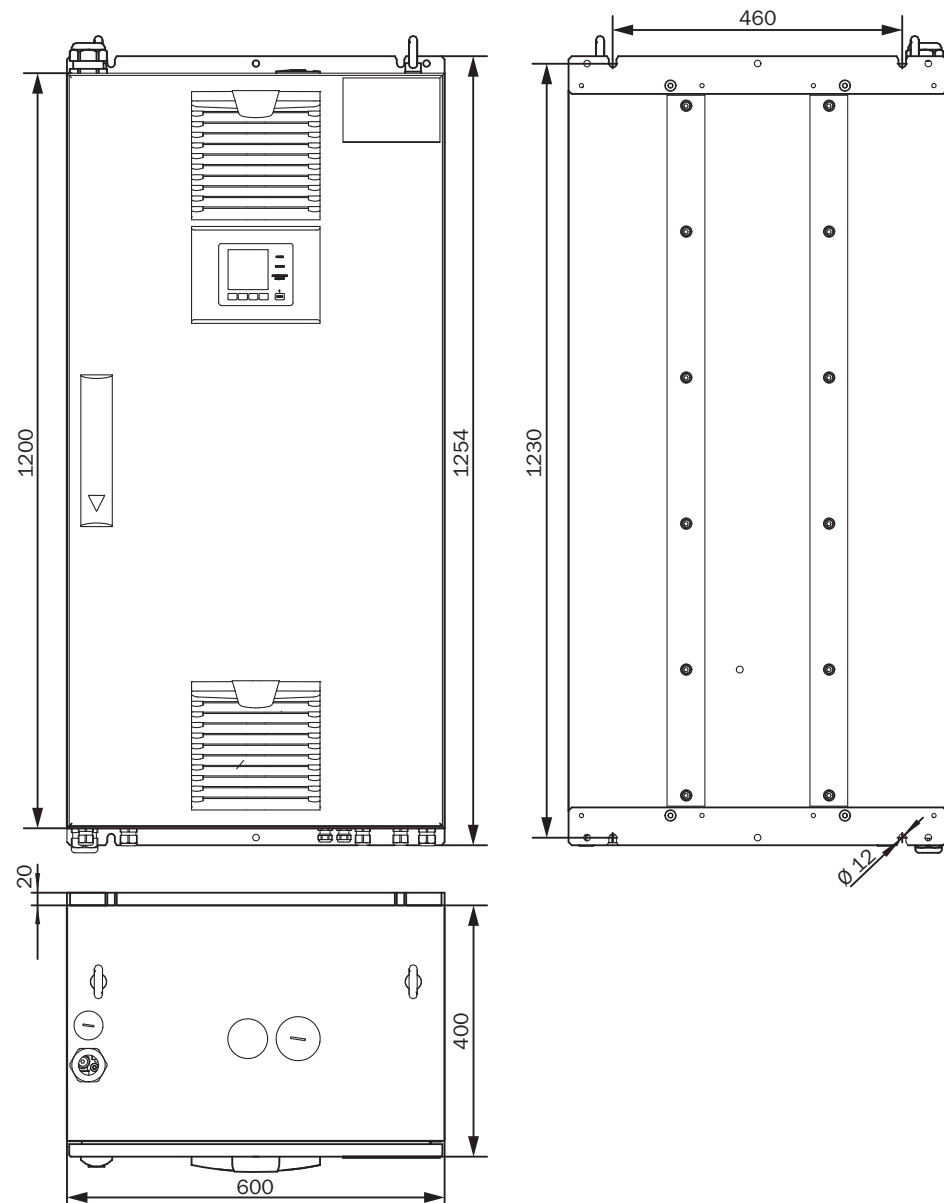

Figure 6: Analyzer cabinet - dimensional drawing



NOTICE

Observe clearances:

- Top: 30 cm
- Bottom: 20 cm

- Observe the clearances for the heated sample gas line.
- Install the analyzer in a well ventilated room at a location, when possible, with constant temperature conditions.
- Observe the relevant ambient conditions: [see "Ambient conditions", page 80.](#)
- Attach the enclosure with the mounting brackets provided on a suitable wall with sufficient load-bearing capacity.
- Secure the enclosure with 4 x M10 screw fittings (2 at bottom, 2 at top) with property class 8.8 (or higher).

- Secure the screw fittings against loosening.
- Drilling plan: See dimension drawings above.
- Install the enclosure horizontal.

2.9 Connect the sample gas line to the analyzer



WARNING

Danger to life by electric voltage

- ▶ Only allow an authorized electrician to work on the electric system

Connect heated sample gas line to analyzer

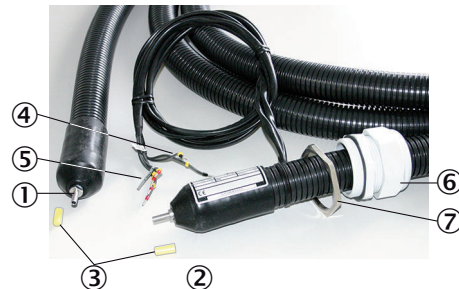

The flexible wires of the heated sample gas line are numbered.

Line assignment: [see "Heated sample gas lines", page 81](#)

Figure 7: Heated sample gas line

- ① Connection side without electric connections on gas sampling system
- ② Connection side with electric connections on analyzer
- ③ Protective cap
- ④ 2 x Pt100 connections (1 as reserve)
- ⑤ Power supply
- ⑥ Cable gland
- ⑦ Counter nut

1. Unscrew counter nut from the cable gland and pull off the sample gas line.
2. Lead sample gas line together with electrical connections from above through the housing opening on the analyzer.
3. Push counter nut back over the sample gas line and electric connections.

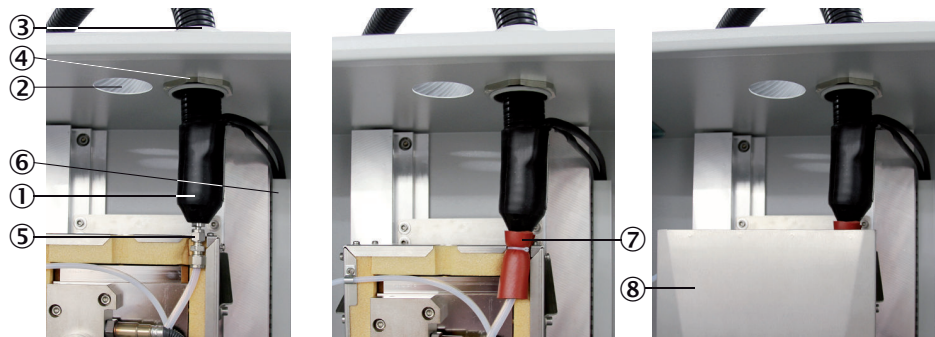

Figure 8: Sample gas line - connection diagram

- ① Sample gas line 1
- ② Sample gas line 2 (option)
- ③ Cable gland
- ④ Counter nut
- ⑤ Clamping ring screw connection (cell)

- ⑥ Cable duct
 - ⑦ Foam insulation
 - ⑧ Finished assembly
4. Screw counter nut tight on the cable gland.
 5. Unscrew cell cover and remove.



CAUTION
Hot parts in cell.

- ▶ Let cell cool down before working on the cell.

6. Remove protective cap from sample gas line.
7. Insert sample gas line to stop in the clamping ring screw connection on the cell.
With 2 sample gas lines: Observe inlets:
 - Right inlet: Measuring point 1
 - Left inlet: Measuring point 2
8. Screw sample gas line tight on the clamping ring screw connection.
9. Attach red foam insulation on the clamping ring screw connection and bind together with a cable clip. No thermal bridges may remain.
10. Close cell again.
11. Screw cable gland tight.
12. Push electric lines downwards through the cable duct.
13. Connect power supply of the sample gas line:

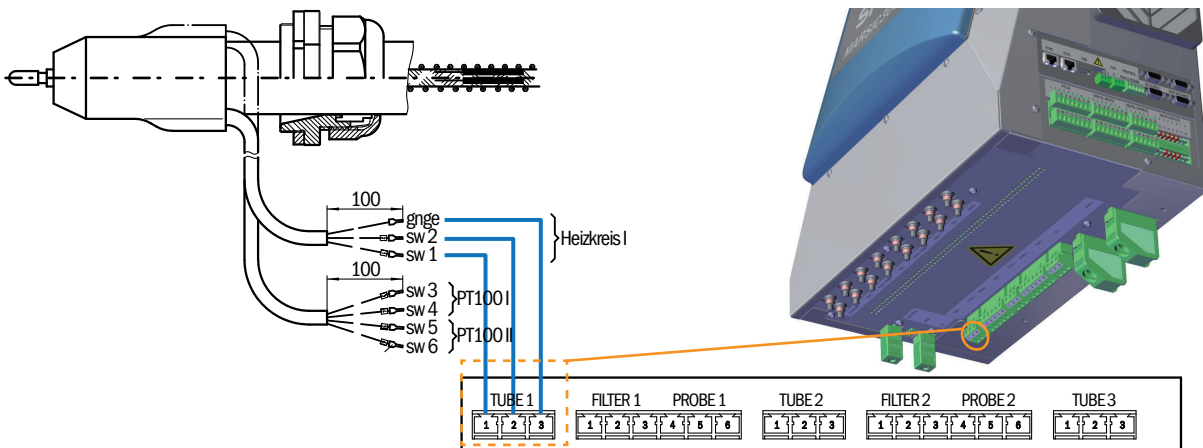

Figure 9: Power supply connection

Complete description of the interface on [page 82](#).

- ▶ Connect the optional second sample gas line (TUBE 2).



NOTICE

The connections on MARSIC300 must match the connections of the gas sampling system.

14. Connect Pt100 of the sample gas line:

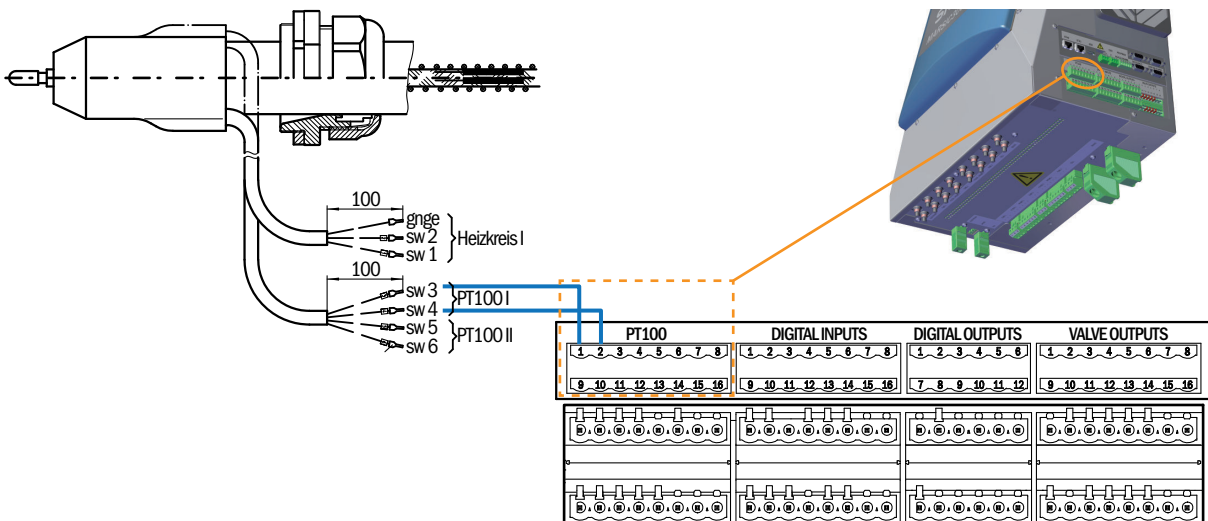

Figure 10: Pt100 connection

Complete description of the interface on [page 86](#).

15. Connect Pt100 from the sample gas line 2 to pins 9 and 10.

2.10 Connecting the tube bundle cable to the analyzer



Figure 11: Analyzer - overview

- ① Tube bundle cable 1
- ② Tube bundle cable 2 (optional)
- ③ Valve block
- ④ Electronics unit

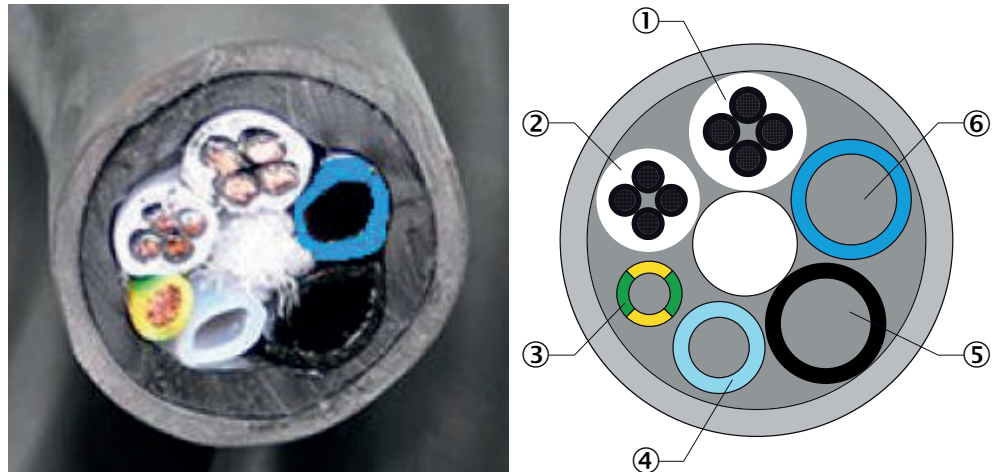

Figure 12: Tube bundle cable - overview

- ① Power supply
- ② Pt100 lines
- ③ Grounding conductor
- ④ PTFE tube DN4/6
- ⑤ PA tube black DN6/8; Imprint "1"
Connections on analyzer and gas sampling probe must match
- ⑥ PA tube black DN6/8; Imprint "2"
Connections on analyzer and gas sampling probe must match

No.	Designation	Function	Dimension
①	Power supplies	Lines 1 and 2: Gas sampling filter Lines 3 and 4: Probe tube (optional)	4 x 1.5 mm ²
②	Signal lines (Pt100)	Lines 1 and 2: Gas sampling filter Lines 3 and 4: Probe tube (optional)	4 x 1.0 mm ²
③	Grounding conductor (gnge)	Ground	1 x 4.0 mm ²
④	PTFE hose (white)	Zero gas	DN 4/6
⑤	PA hose (black)	Control air main valve	DN 6/8
⑥	PA hose (blue)	Backflush air	DN 6/8



WARNING

Danger to life by electric voltage

- ▶ Only allow an authorized electrician to work on the electric system



CAUTION

The tube bundle cable is unusable when it is cut off too short.

The tube bundle cable is unusable when a lead inside is damaged when removing the sheath.

- ▶ If the tube bundle cable is long enough: Leave a piece as "reserve".
- ▶ Only remove the sheath from the tube bundle cable when you are technically capable of doing this.

1. Remove 1900 mm of the tube bundle cable sheath.
2. Lead the tube bundle cable through the screw fitting on the enclosure top.
3. Lead tubes and lines of the tube bundle cable downwards in the cable duct.

- Connect the 3 gas lines of one tube bundle cable to the valve block (connections marked as "outlet" in the Figure below).

NOTICE

The gas connections on the valve block must match the gas connections of the gas sampling system (see "SFU Gas Sampling System Operating Instructions").

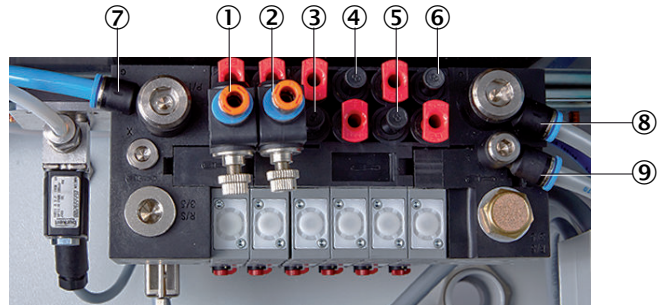

Figure 13: Valve block

- ① Outlet: Zero gas measuring point 1
- ② Outlet: Zero gas measuring point 2 (option)
- ③ Outlet: Control air measuring point 1
- ④ Outlet: Backflush air measuring point 1
- ⑤ Outlet: Control air measuring point 2 (option)
- ⑥ Outlet: Backflush air measuring point 2 (option)
- ⑦ Inlet: Zero gas
- ⑧ Inlet: Control/backflush air
- ⑨ Inlet: Auxiliary control air
- Red plug = dummy plug

- Connect the heating of the gas sampling system (heated sample gas filter and optional heated probe tube).



NOTICE

The connections on MARSIC300 must match the connections of the gas sampling system.

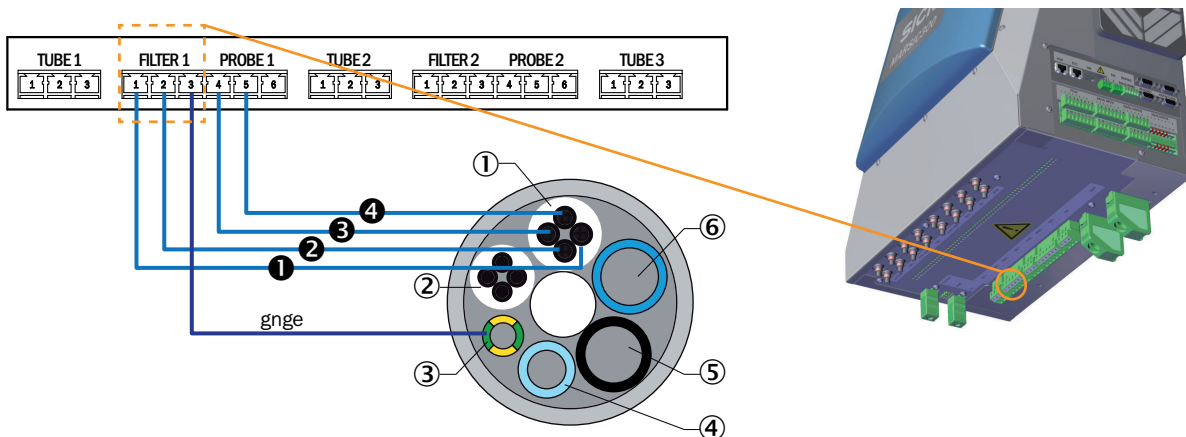

Figure 14: Supply lines - tube bundle cable connection diagram

Complete description of the interface, see "Tube bundle cable", page 81 Tube bundle cable 2 optional to tube bundle cable 1.

- Connect the Pt100 of the gas sampling system (heated sample gas filter and optional heated probe tube).



NOTICE

The connections on MARSIC300 must match the connections of the gas sampling system.

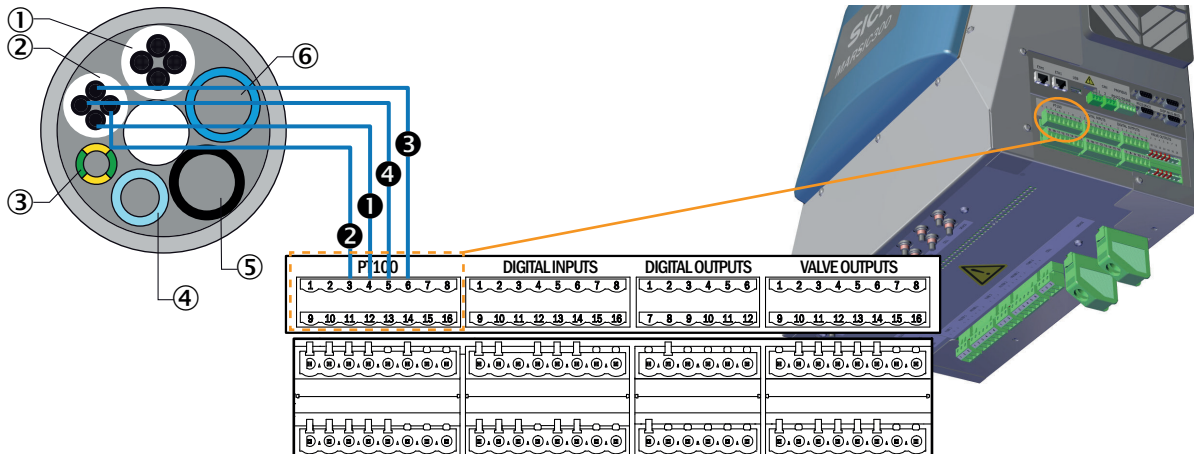

Figure 15: Signal lines - tube bundle cable connection diagram

2.11 Connecting the signal lines to the analyzer

4 digital inputs and outputs each are available as an option that must then be configured, see "Data interfaces / IO", page 55.

4 digital inputs

- Fill level signal, condensate container
- Condition, instrument air
- Scrubber system on/off (can be linked with StBy MARSIC300)
- Temperature error, weatherproof cover or other external alarm

4 digital outputs

- Status (OK / Maintenance)
- Status (OK / Failure)
- Coefficient SO₂/CO₂ less than/greater than xy (definable)

The inputs and outputs are deactivated as standard. The inputs and outputs can be activated and negated in SOPAS ET.

Digital inputs and outputs can also be redefined differently to the above description.

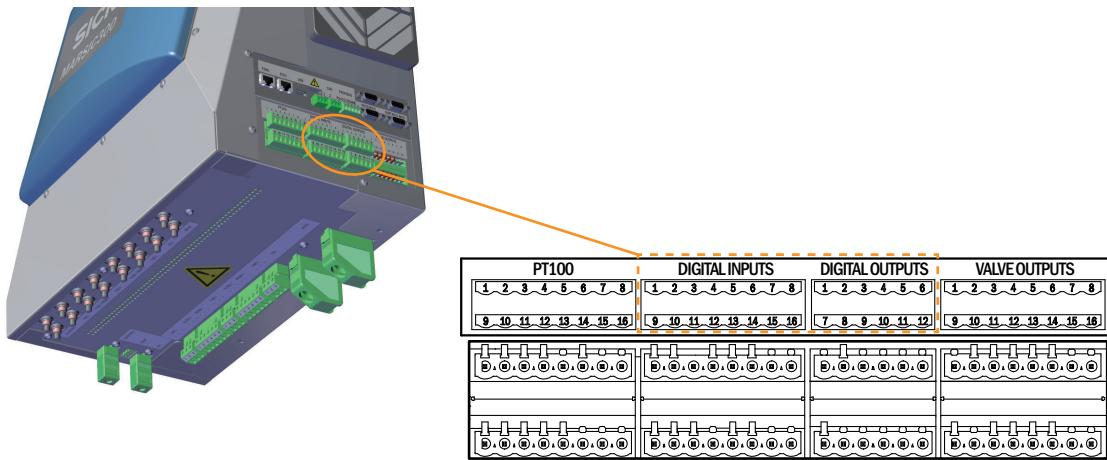

Figure 16: Connection diagram - digital connections

2.12 Air and gas connections on analyzer



WARNING

Hazard when pressure is too high
Hoses can burst when the pressure is too high.

- ▶ Observe the maximum pressures of the gases provided by the operator: see "Supply gases", page 87.

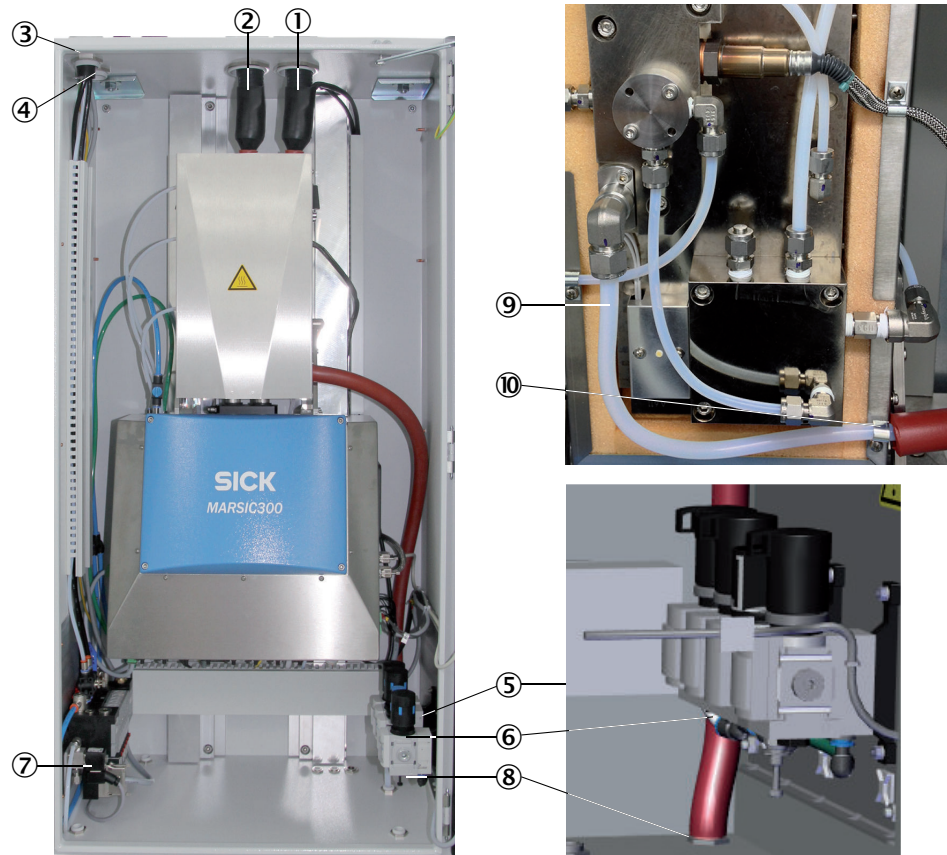

Figure 17: Overview - air and gas connections

- ① Heated sample gas line for measuring point 1
- ② Heated sample gas line for measuring point 2 (option)

- ③ Tube bundle cable 1
- ④ Tube bundle cable 2 (option)
- ⑤ Pressure reducer unit
- ⑥ Instrument air as zero gas/test gas (option)
- ⑦ Test gas inlet
- ⑧ Sample gas outlet
- ⑨ Sample gas outlet on cell
- ⑩ Fixing of line sample gas outlet on the cell

Connect instrument air

Connect instrument air to the pressure control unit.



ATTENTION

Risk of contamination of the analyzer by unclean instrument air.

- ▶ Only use instrument air corresponding to the mandatory specification (see "Technical data", page 78).
- ▶ Install a suitable instrument air conditioning when necessary.

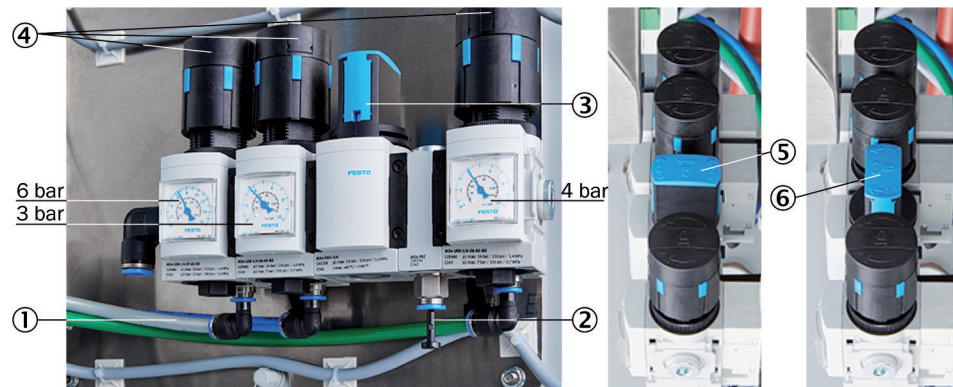

Figure 18: Pressure reducer unit

- ① Instrument air inlet with zero gas quality
- ② Instrument air inlet for induction air ejector only
- ③ Manual valve for instrument air selection
- ④ 3 pressure reducers (adjustable)
- ⑤ Manual valve - closed position
- ⑥ Manual valve - open position

The instrument air is used as both induction air for the ejector (cell) and zero/control air.

Instrument air can be connected in 2 ways:

- ▶ One common instrument air supply for ejector air and zero/control air (inlet 1).
- ▶ Separate instrument air supply for:
 - Ejector air (inlet 2)
 - and zero/control air (inlet 1)

Instrument air quality

The requirements for instrument air quality are lower when the air is only used as ejector air than when used as zero/control air (zero gas quality) (see "Supply gases", page 87).

- ▶ When connected just as instrument air supply with zero gas quality to be used as common air for both ejector air and zero/control air (on inlet 1):

- ▷ Set manual valve to position “open”.
- ▶ When connected as one instrument air supply for the ejector (on inlet 2) and one instrument air supply with zero gas quality (on inlet 1):
 - ▷ Set manual valve to position “closed”.

Connect span gas (option)



WARNING

Hazard when pressure is too high
Hoses can burst when the pressure is too high.

- ▶ Observe the maximum pressures of the gases provided by the operator: [see "Supply gases", page 87](#).

Connect span gas to the span gas valve.

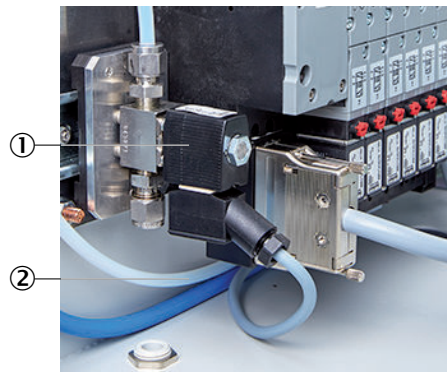

Figure 19: Test gas valve connection

- ① Test gas valve
- ② Test gas inlet

Connect sample gas outlet



CAUTION

Acidic condensate in sample gas outlet - risk of blockage
Acidic condensate forms in the sample gas outlet.

- ▶ Always lay the sample gas outlet line running downwards so that no condensate can accumulate.
- ▶ Lay the line end in a suitable disposal device (drain or condensate collection container).
- ▶ Do not kink the line and protect against frost.

The analyzer is fitted with an outlet hose (DIN 8/10) about 30 cm long when delivered.

- Lay the sample gas outlet in a suitable exhaust duct.
- The sample gas outlet must be open to the ambient pressure.

Recommendation for lengthening the outlet hose:

To prevent the outlet line clogging, it is recommended to lay a (1) new line starting at the sample gas outlet of the cell to the disposal location.

To do this, [see figure 17, page 20](#):

1. Open cell cover (loosen 4 screws on the side).
2. Unscrew sample gas outlet line on the sample gas outlet (bracket piece).
3. Loosen fixing of sample gas outlet line.

4. Remove the thermal insulation from the existing line and remove the line.
5. Lead a new line through the enclosure duct at the bottom on the enclosure floor and connect it to the sample gas outlet of the cell.
6. Refit the fixing.
7. Refit the thermal insulation.
8. Close cell again.

To lengthen the existing hose piece: No cross-section narrowing may occur when connecting the lengthening hose.

Sample gas outlet on housing:

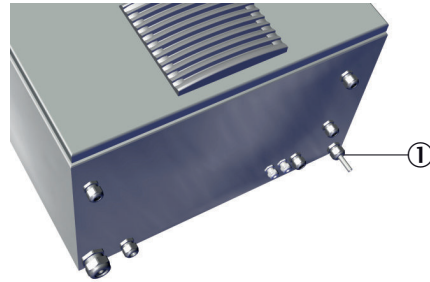

Figure 20: Sample gas outlet - enclosure underside

- ① Sample gas outlet at bottom rear of the housing

2.13 Electrical connections on the analyzer

Connect power supply



ATTENTION

The analyzer power supply is configured for an individual power system. Check the configured power system against the system documentation provided.

- If the analyzer power system does not match the power system on board: Please contact SICK Customer Service.

The power supply is located on the left on the analyzer.

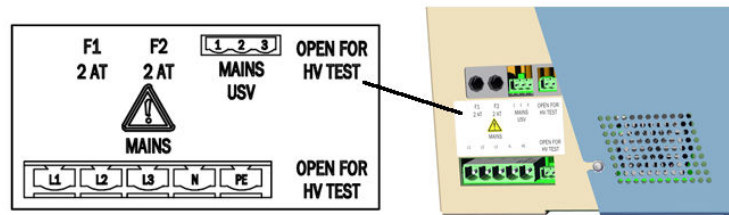

Figure 21: Power supply connections



NOTICE

- Install an external power disconnection unit which disconnects all connectors and fuses near the analyzer.
- The power disconnection unit must be marked clearly and be easily accessible.
Observe the maximum power input of the complete system: see "Power supply", page 82.
- The onsite wiring system to the power source of the system must be installed and fused according to the relevant regulations.
- Always connect a protective ground to PE.

- ▶ Route the electric lines through the screw fittings of the enclosure.
- ▶ Connect the electric lines.

Connect signal line (optional)

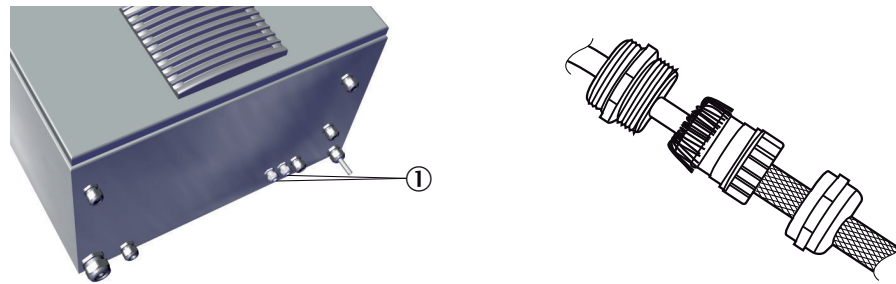

① 2 x signal line ducts

- ▶ Lead cable through the enclosure duct.
- ▶ Attach shield as shown in the Figure above.

Connect Ethernet (optional)

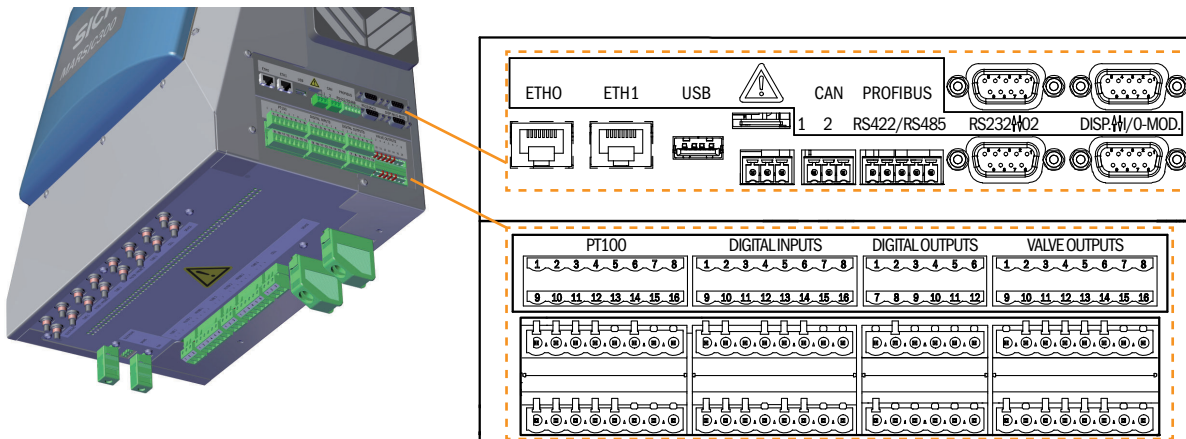
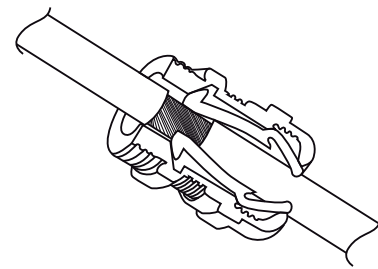
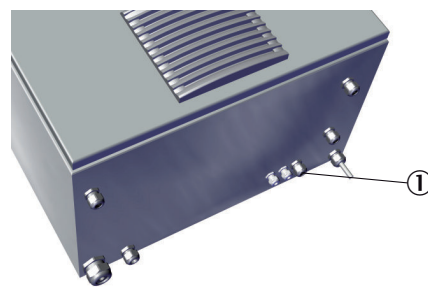

Figure 22: Connections overview

Table 4: Data interfaces - overview

Plug	Connection for
ETH0	Ethernet (e.g. SOPAS ET), MPR (remote maintenance), communication via Modbus TCP
ETH1	Internal
USB	Internal
SD card	SD card (on the right, next to USB)
CAN1	Internal
CAN2	Internal
RS422, RS485	Internal
RS232 (top plug)	Internal
O2 (bottom plug)	O ₂ sensor
DISP (top plug)	Display
I/O-MOD (bottom plug)	Internal



① Ethernet cable duct

- ▶ Lead cable through the enclosure duct.
- ▶ Attach shield as shown in the corresponding Figure above.
- ▶ Connect Ethernet to ETH0 (network or computer with SOPAS ET). Plug type: RJ 45.
- ▶ Connect MPR (remote maintenance via SICK Meeting-Point Router) to ETH0. Further information, see “MPR Operating Instructions”.

2.14 Installing the gas sampling system



NOTICE

- ▶ Observe the ambient conditions of the gas sampling system: See “SFU Gas Sampling System Operating Instructions”.
- ▶ Leave the sample gas line and tube bundle cable long enough to be able to pull the sample gas system out of the exhaust duct.
- ▶ All connections must match the connections in the analyzer (see ["Connecting the tube bundle cable to the analyzer"](#), page 16 and see ["Connect the sample gas line to the analyzer"](#), page 14).

Fitting the flange

- ▶ Install the flange of the gas sampling system as described in the “SFU Gas Sampling System Operating Instructions”.
 - Observe the 10° tilt of the probe tube during installation.

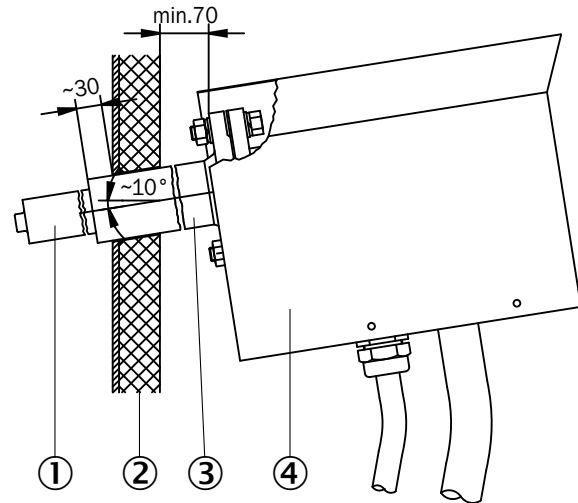

Figure 23: Flange assembly

- ① Probe tube
- ② Stack wall
- ③ Welding neck flange
- ④ Gas sampling filter

Gas connections

- ▶ Connect the following gas connections on the gas sampling system:
 - Heated sample gas line
 - Tube bundle cable
 - Black line 1: Main valve
 - Blue line 2: Backflush
 - White PTFE tube: Instrument air/test gas

Electrical connections

- ▶ Connect the following electric lines of the tube bundle cable on the gas sampling system:
 - Power supply, gas sampling system
 - Power supply, probe tube (when heated)
 - Filter Pt100 line
 - Pt100 line, probe tube (optional, when heated)

Tube bundle cable

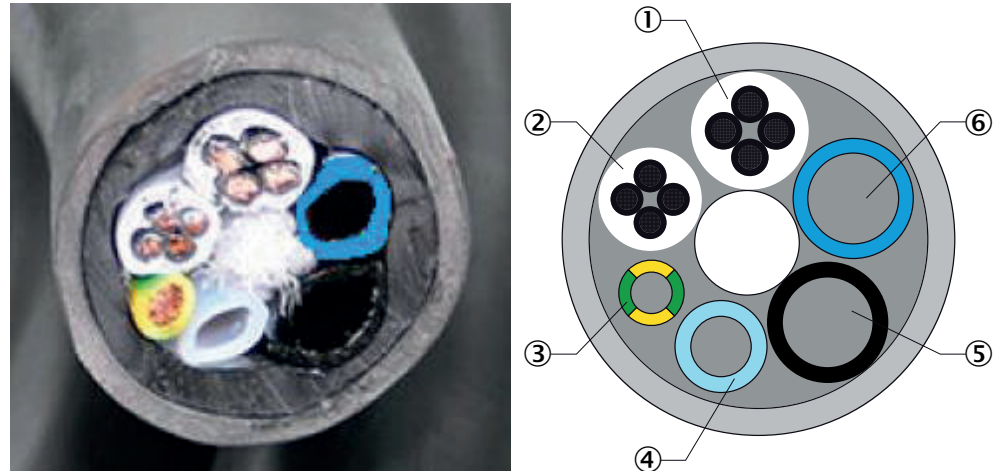

Figure 24: Tube bundle cable - overview

- ① Power supply
- ② Pt100 lines
- ③ Grounding conductor
- ④ PTFE tube DN4/6
- ⑤ PA tube black DN6/8; Imprint “1”
Connections on analyzer and gas sampling probe must match
- ⑥ PA tube black DN6/8; Imprint “2”
Connections on analyzer and gas sampling probe must match

No.	Name	Function	Dimension
①	Power supplies	Lines 1 and 2: Gas sampling filter Lines 3 and 4: Probe tube (optional)	4 x 1.5 mm ²
②	Signal lines (Pt100)	Lines 1 and 2: Gas sampling filter Lines 3 and 4: Probe tube (optional)	4 x 1.0 mm ²
③	Grounding conductor (gnge)	Ground	1 x 4.0 mm ²
④	PTFE hose (white)	Zero gas	DN 4/6
⑤	PA hose (black)	Control air, main valve	DN 6/8
⑥	PA hose (blue)	Backflush air	DN 6/8

Fit the gas sampling system on the flange



NOTICE

Risk of contamination of gas sampling system

- ▶ First install the gas sampling system on the exhaust duct just before the analyzer is switched on.
- ▶ Install the gas sampling system: See “SFU Gas Sampling System Operating Instructions”.

2.15 Setting up the Modbus-Profinet converter (optional)

As an option to Modbus, the MARSIC300 can also be configured with a Profinet or Profibus protocol. This requires an external Modbus-Profinet converter that may require some adjustments.

Configuration:

1. Install the converter onsite on a DIN rail and create a connection to the MAR-SIC300 (Modbus-TCP).
2. Connect the converter to 24 V DC.
3. Connect a PC via one of the Modbus-TCP connections of the converter with a network cable (crossover not required).
Use the "IP config" software on the Product-CD to find the IP address of the converter in the network using its MAC address (the MAC address is on a label on the converter (next to the TCP interface).

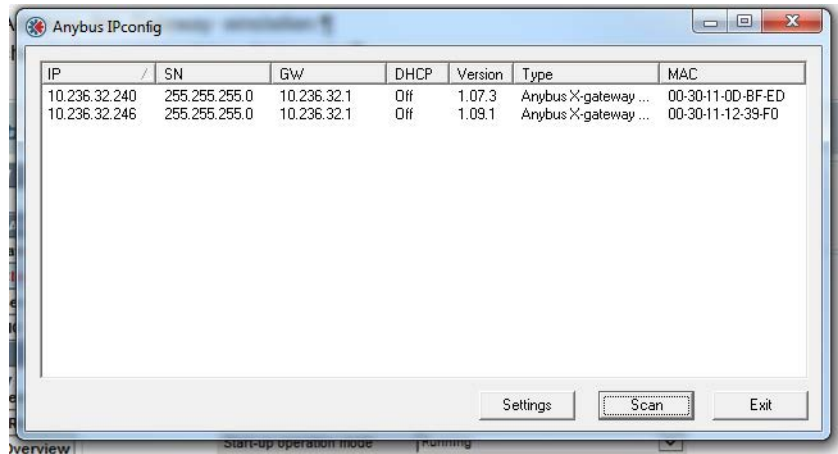

Figure 25: Menu window Anybus IPconfig

4. Start a web browser (IE7.0 or 8.0), enter the IP address and a connection to x-Gateway to the web interface.
5. Define your specific IP address incl. subnet of the converter that matches your network and safety settings.

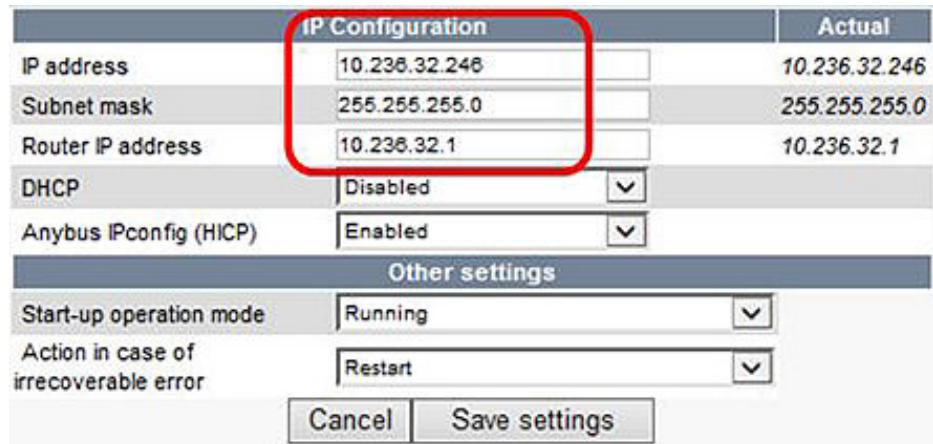

Figure 26: Menu Configuration/Modbus Client

6. Enter the name, IP address and port of the MARSIC300.

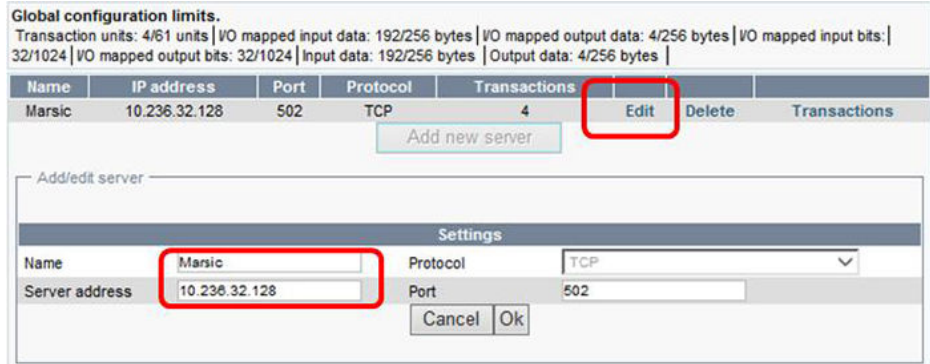

Figure 27: Menu Configuration/Modbus Servers

7. Enter address from PROFINET and save the settings. The address must be the same as in the operator-side SPS.

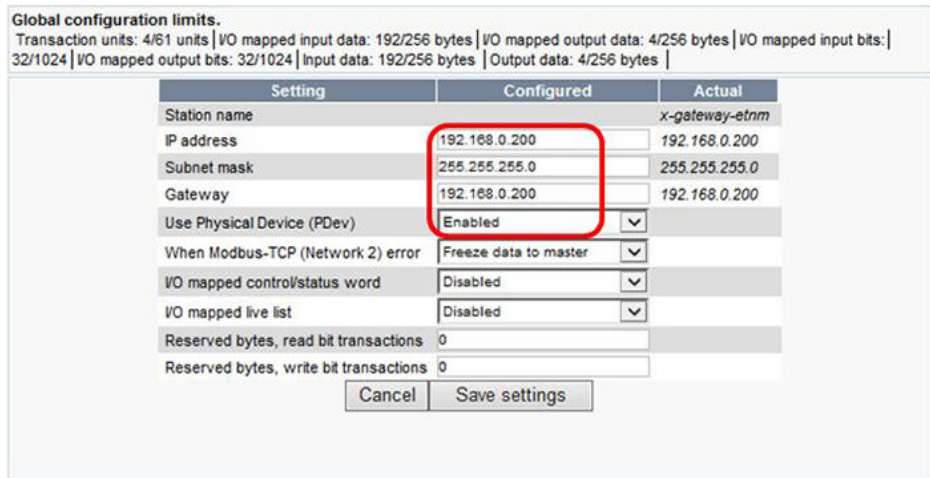

Figure 28: Menu Configuration/PROFINET IO

8. Click "Apply" to activate all changes.

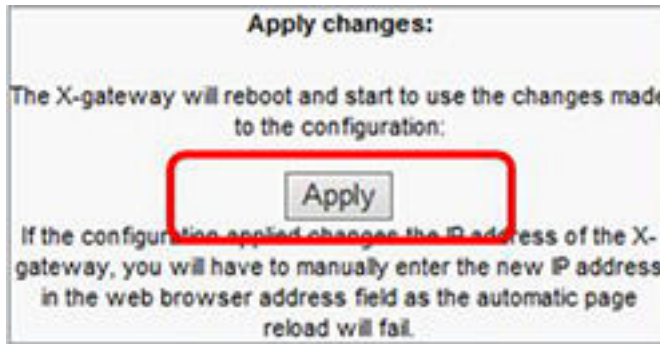

Figure 29: Menu Tools/X-gateway management

9. Setup the hardware configuration on the operator-side (operator SPS) according to the following Table:

Network 1 (PROFINET IO)					
SLOT DETAILS Cyclic I/O					
Slot	Transaction name	In slot Range (bytes)	Absolute range (bytes)	Input words	Output words
1	Packed Modbus read bits	0 .. 3	0 .. 3	2	-
	Read_States	0.0 .. 3.7	0.0 .. 3.7		
2	Measure_Signals	0 .. 107	4 .. 111	54	-
	Diagnie_Signals	0 .. 79	112 .. 191	40	-
4	Packed Modbus write bits	0 .. 3	0 .. 3	-	2
	Write_Coils	0.0 .. 3.7	0.0 .. 3.7		

PARAMETER DATA, Acyclic I/O

Figure 30: Byte sequence

- Set the byte sequence. The byte sequence can be set in MARSIC300 when desired.
A connection to the PC with SOPAS ET is then necessary.

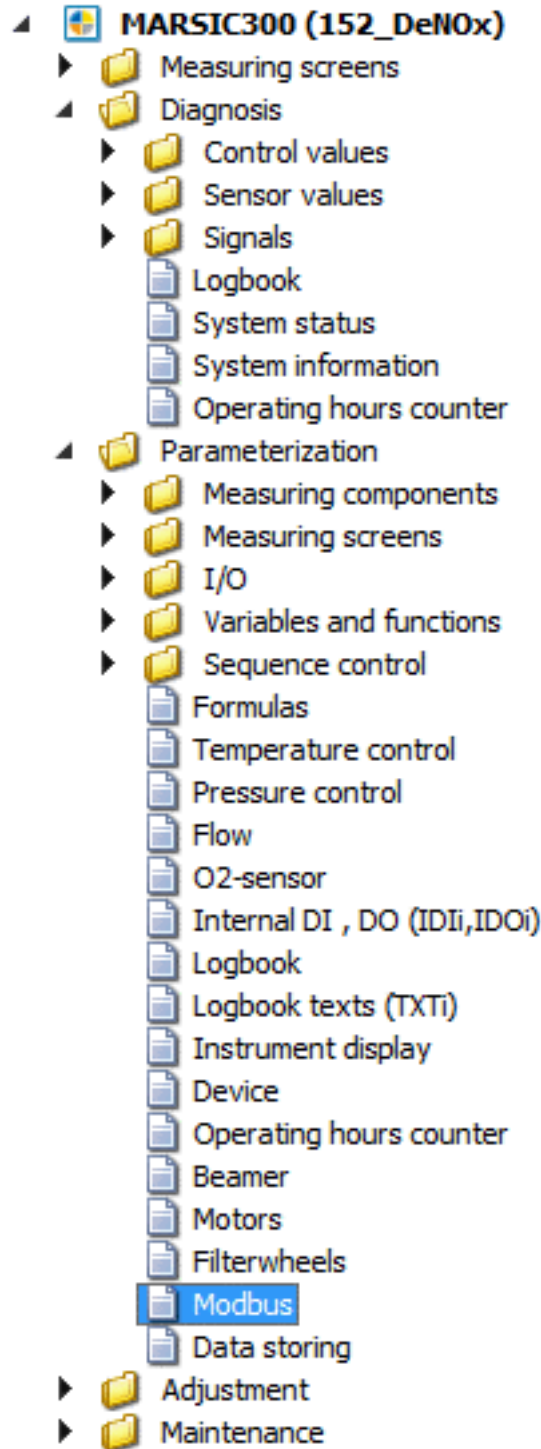

Figure 31: Menu Tree Parameters/Modbus in SOPAS ET

Set the register swap in SOPAS ET to CD_AB for Siemens controls.

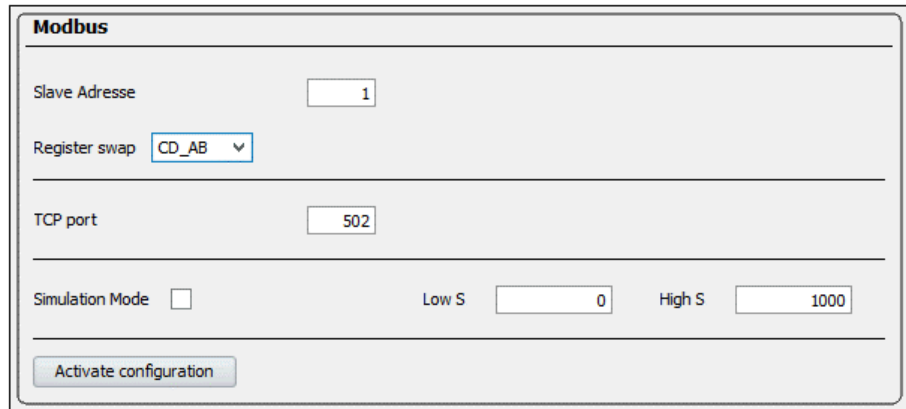

Figure 32: Menu Modbus in SOPAS ET

2.16 Setting up the Modbus-Profinet converter (optional)

As an option to Modbus, the MARSIC300 can also be configured with a Profinet or Profibus protocol. This requires an external Modbus-Profibus converter that may have to be adjusted.

How to configure the external converter is described in the following:

1. Install the converter onsite on a DIN rail and create a connection to the MARSIC300 (Modbus-TCP).
2. Connect the converter to 24 V DC.
3. Connect a PC via one of the Modbus-TCP connections of the converter with a network cable (crossover not required).

Use the “IP config” software on the Product-CD to find the IP address of the converter in the network using its MAC address (the MAC address is on a label on the converter (next to the TCP interface).

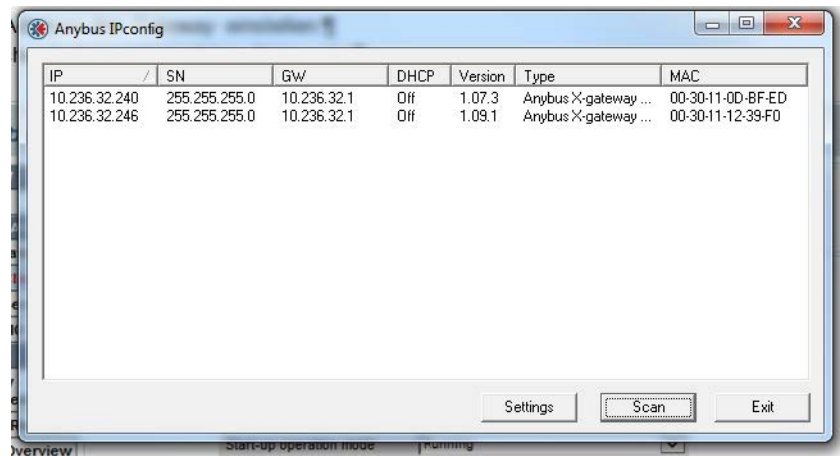

Figure 33: Menu window Anybus IPconfig

4. Start a web browser (IE7.0 or 8.0), enter the IP address and a connection to x-Gateway to the web interface.
5. Define your specific IP address incl. subnet of the converter that matches your network and safety settings.

IP Configuration		Actual
IP address	10.236.32.246	10.236.32.246
Subnet mask	255.255.255.0	255.255.255.0
Router IP address	10.236.32.1	10.236.32.1
DHCP	Disabled	
Anybus IPconfig (HICP)	Enabled	

Other settings	
Start-up operation mode	Running
Action in case of irrecoverable error	Restart

Cancel Save settings

Figure 34: Menu Configuration/Modbus Client

- Enter the name, IP address and port of the MARSIC300.

Global configuration limits.
 Transactions: 4/64 | I/O mapped input data: 192/244 bytes | I/O mapped output data: 4/244 bytes | I/O mapped input bits: 32/1024 | I/O mapped output bits: 32/1024 | Input data: 192/256 bytes | Output data: 4/256 bytes | Total I/O mapped data: 196/368 bytes

Name	IP address	Port	Protocol	Transactions			
Marsic	10.236.32.128	502	TCP	4	Edit	Delete	Transactions

Add new server

Add/edit server

Settings			
Name	Marsic	Protocol	TCP
Server address	10.236.32.128	Port	502

Cancel Ok

Figure 35: Menu Configuration/Modbus Servers

- Enter the address of PROFIBUS and save the settings. The address must be the same as in the operator-side SPS.

Global configuration limits.
 Transactions: 4/64 | I/O mapped input data: 192/244 bytes | I/O mapped output data: 4/244 bytes | I/O mapped input bits: 32/1024 | I/O mapped output bits: 32/1024 | Input data: 192/256 bytes | Output data: 4/256 bytes | Total I/O mapped data: 196/368 bytes

Setting	Configured	Actual
Node address	71	71
When Modbus-TCP (Network 2) error	Freeze data to master	
I/O mapped control/status word	Disabled	
I/O mapped live list	Disabled	
Reserved bytes, read bit transactions	0	
Reserved bytes, write bit transactions	0	

Cancel Save settings

Figure 36: Menu Configuration/PROFIBUS DP-V1

- Click "Apply" to activate all changes.



Figure 37: Menu Tools/X-gateway management

9. Setup the hardware configuration on the operator-side (operator SPS) according to the following Table:

Network 1 (PROFIBUS DP-V1)				
CONFIGURATION DATA				
Slot	CFG data	Designation	Data	
			Input words	Output words
1	0x40,0xf7	Input data	36	-
2	0x40,0xe7	Input data	40	-
3	0x80,0xc1	Output data	-	2

Figure 38: Byte sequence

10. Set the byte sequence. The byte sequence can be set in MARSIC300 when desired.
A connection to the PC with SOPAS ET is then necessary.

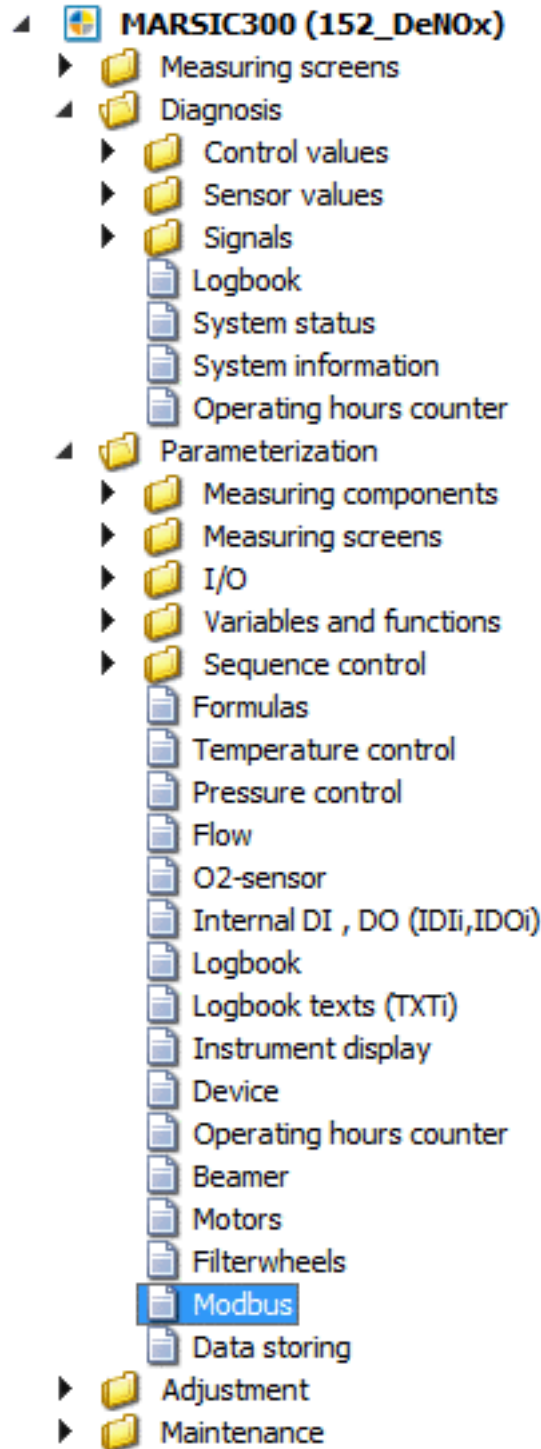

Figure 39: Menu Tree Parameters/Modbus in SOPAS ET

Set the register swap in SOPAS ET to CD_AB for Siemens controls.

Modbus

Slave Adresse

Register swap

TCP port

Simulation Mode Low S High S

Figure 40: Menu Modbus in SOPAS ET

3 Initial start-up



NOTE

Prerequisite: The system is completely installed and connected.

Before switching on

1. Check connections are connected properly as described in the "Installation" Chapters.
2. Relieve the pressure on all pressure regulators in the analyzer (see ["Air and gas connections on analyzer", page 20](#)): Turn the regulators counterclockwise.
3. Adjust the manual valve in the analyzer as described in see ["Air and gas connections on analyzer", page 20](#).
4. Open the external instrument air supply.
5. Set pressures: see ["Air and gas connections on analyzer", page 20](#).
6. Check the power supply of the analyzer matches the setting on the ship network: see ["Electrical connections on the analyzer", page 23](#).
7. Check the voltage connection on the gas sampling system.
8. Install the gas sampling system on the flange of the exhaust duct: See "SFU Gas Sampling System Operating Instructions".

Switching on

1. Switch on the external power disconnection unit.
2. The **green** "Power" LED on the control panel goes on: Energy supply is available.
3. The yellow and red LEDs go on sporadically.
4. **Booting** appears several times on the screen.
5. The Measuring screen appears.
6. The system heats up:
 - **Only** the **green** LED is on.
 - Display: **Init/Heating up**.
A downwards counter displays the maximum duration of the process.
7. Display: **Conditioning**.
8. Only the **green** LED is on and **Measuring** is shown in the status line.
The system is ready for operation.
If a measured values blinks: The measured value is outside the calibration range.
When the yellow or red LED is on: Press the Diag button and clear the error: Error list see ["Error messages and possible causes", page 93](#).

Final tests and parameter settings

1. Perform a leak tightness check: see ["Leak tightness check during initial startup", page 75](#).
2. Perform an internal adjustment: Display menu Adjustment/internal adjustment.
3. Connect computer with SOPAS ET on ETH0 (see ["Connections in analyzer", page 83](#)) (see ["Software SOPAS ET", page 39](#)).
If the customer network is already connected: Disconnect the customer network.
4. If required: Set the times for automatic adjustments.
 - ▷ To change in SOPAS ET: Menu Adjustment/Parameter/Start times.
5. If required: Configure the measuring point switchover.
 - ▷ In SOPAS ET: Menu Parameterization/Sequence Controls/Sampling point program.
6. Set the IP address of the customer network for the ETH0.
 - In the SOPAS ET user interface: Click the pen symbol in the device tile of the MARSIC300.

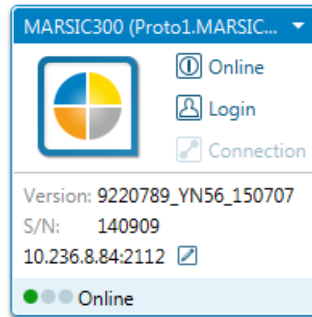

Figure 41: SOPAS ET device tile

7. Disconnect the computer from ETH0 and connect the customer network to ETH0.

Initial start-up is completed.

4 Configuration software

4.1 Software SOPAS ET

SOPAS ET can also be used to configure MARSIC300 and to access the MARSIC300 logbook.

SOPAS ET runs on an external PC connected to the MARSIC300 via the Ethernet interface.

Connect MARSIC300 with software SOPAS ET

1. Make sure all electric and pneumatic connections are connected properly, start-up has been carried out correctly and the system is running without error messages. Connect your computer with SICK software SOPAS ET installed (on the Product CD or free in internet under www.sick.com):

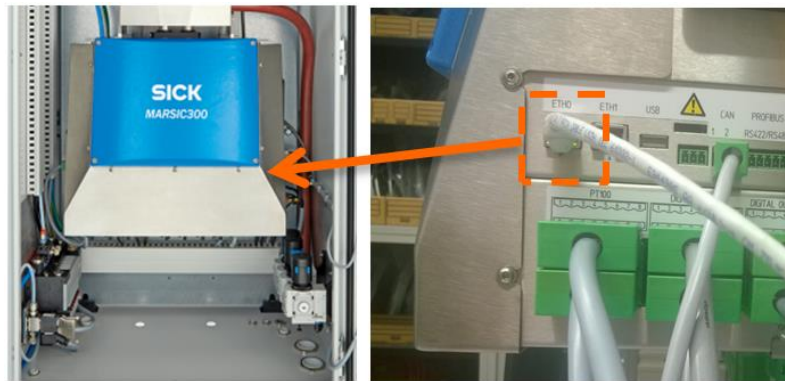

Figure 42: MARSIC300 network connection



NOTE

SOPAS ET connects automatically the first time MARSIC300 is started and inquires whether the driver files (SDD files) for the connected device should be downloaded. Downloading is not necessary because SOPAS ET loads the driver files direct from the MARSIC300.

2. Start SOPAS ET on the PC and search for devices. When the MARSIC300 appears in the right area in SOPAS ET, drag & drop it to the left Project area. To change the IP setting of the MARSIC300, click on the pen icon (marked red in the Figure) and confirm the message with “Yes”.

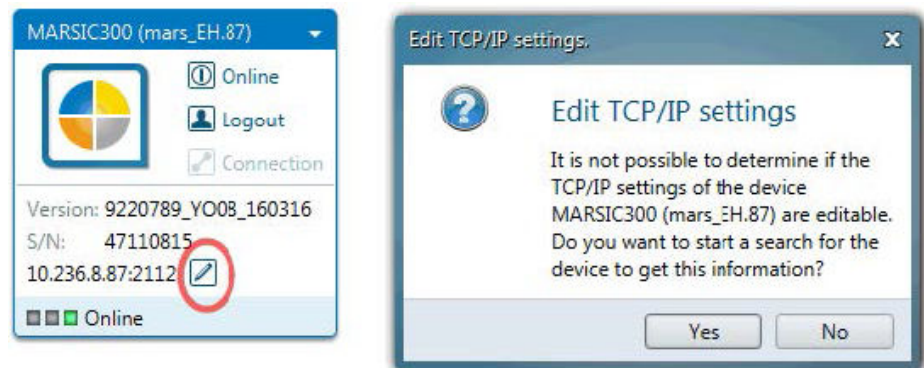
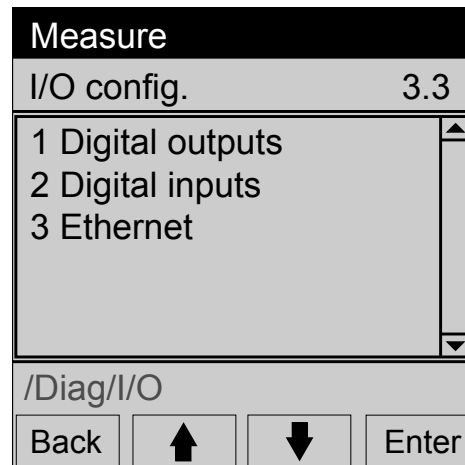

Figure 43: Menu dialog TCP/IP settings

3. If the MARSIC300 was not found, login on the MARSIC300 on the control panel as “Authorized Operator” (password is “1234”). You can change the network settings

for the MARSIC300 here. Make sure the PC and the MARSIC300 are in the same subnet and no firewall is active.



Set the device parameters matching your network in this menu and confirm with “OK”. A warning appears to confirm that the device is set offline. Confirm with “Yes”. The network configuration has been changed, however the old configuration can still be seen. The IP configuration is updated on the operator panel and in SOPAS ET after a restart (switching the MARSIC300 off and on).

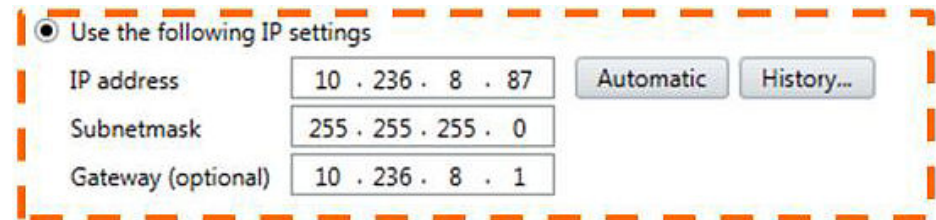

Figure 44: Menu settings IP configuration

After configuration, the MARSIC300 must be adjusted to the network settings of the customer network.

4.2 Saving parameters

SOPAS ET can be used to backup and restore the MARSIC300 parameters:

1. Click the left mouse button to select the desired device in the main window.
2. Select “Project / Project save as” to save the SOPAS ET-Project file in a local directory on the PC.

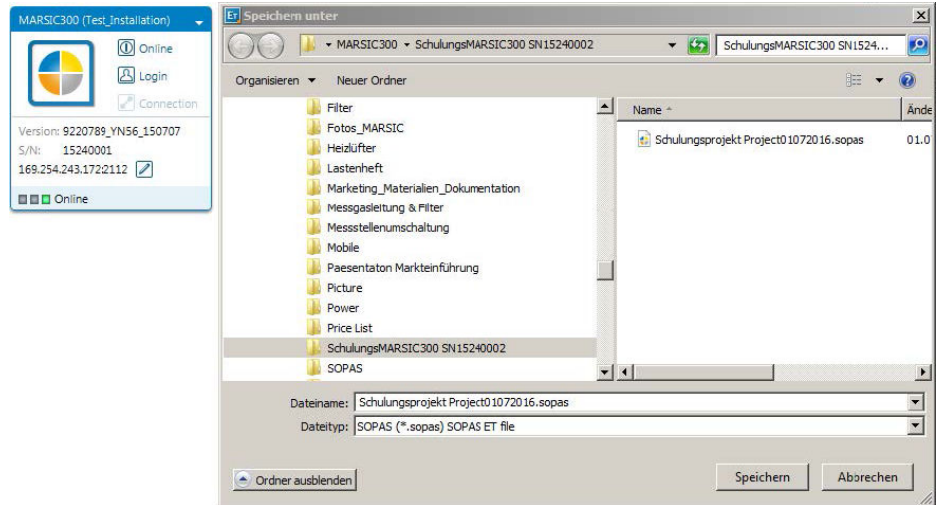

Figure 45: Menu dialog - Save Project file

4.3 Backing up the logbook with SOPAS ET

It is useful for diagnostic purposes when the MARSIC300 logbook is made available to Service. It can be downloaded easily and, e.g. sent per e-mail.

1. Login as “Authorized User”.
2. Select path: MARSIC300 / Diagnosis / Logbook.
3. Select “All” in the scroll down menu.
4. Select “Export” to save the log file in a local directory on the PC.

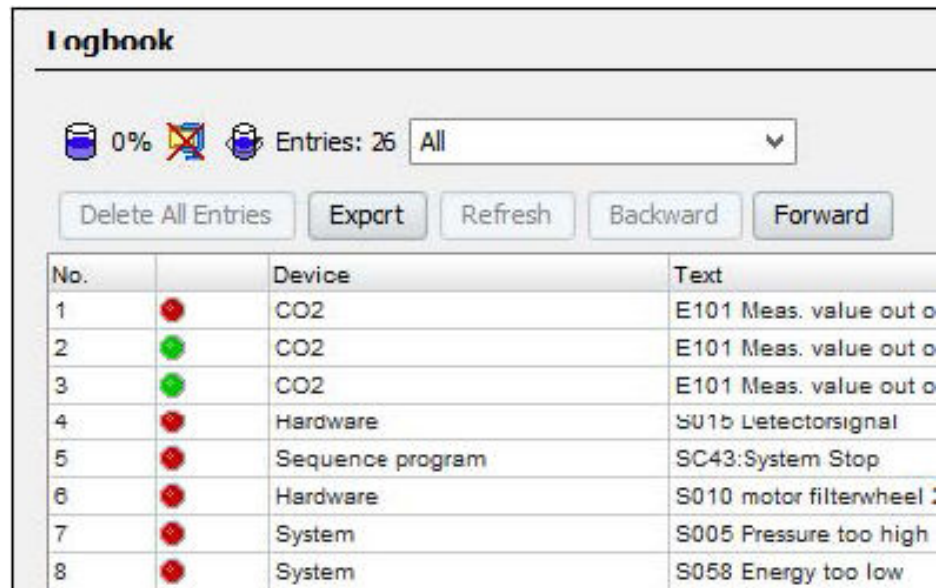

Figure 46: Menu Logbook in SOPAS ET

4.4 Passwords

There are 2 passwords:

Table 5: Passwords

Password for	Password	Change password
Device display access "Authorized User"	1234	Changing the password: see "Instrument display", page 60
SOPAS ET	HIDE	Cannot be changed

4.5 Using the menus

Example: Menu: Parameterization/I/O/Data/External Data/Analog inputs

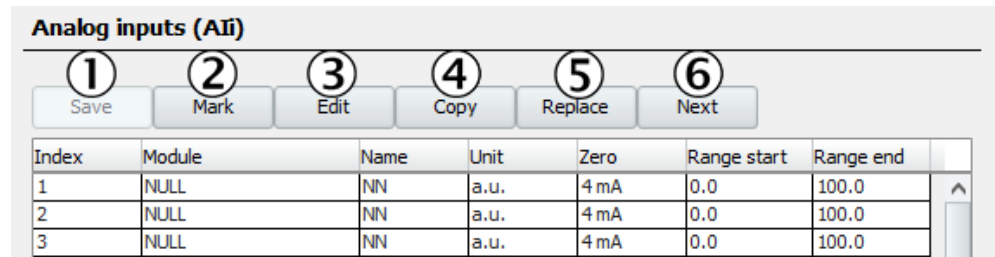

Figure 47: Menu Analog inputs

Table 6: Menu fields legend

Entry field	Significance
①	Save current entries.
②	Create group <ul style="list-style-type: none"> ▶ Click "Mark" and then click the desired lines. ▶ To cancel "Mark": Click "Mark" again and then click an empty line.
③	In editable menus: Call up the setting menu for lines. <ul style="list-style-type: none"> ▶ Click desired line. Then click "Edit".
④	Copy selected lines
⑤	Insert copied lines before a selected line
⑥	Call up "Next function group"

(The bottom lines in the example depend on the menu)

4.6 Menu tree (SOPAS ET)

The menu tree shown here shows the menus for user level "Authorized User".

Menu	Reference
Measuring screen	chapter 5.1
Measuring screens	
Diagnosis	chapter 7
Control values	chapter 7.1
Zero drift	
Span gas drift	
Internal adjustment drift	
Reference energy	
Intensity	
Sensor values	chapter 7.2
Temperatures	
Pressures	
Flow rate	
Cell	
O2 sensor	
Emitter	
Motors	

Hardware	
Signals	chapter 7.3
External signals	
Measuring signals (MVi)	
Diagnosis internal (IDOi, ID)	
Boolean values (BVi, Lli)	
Real values (RVi)	
Modbus values (MBVi)	
Modbus input values (MBiVi)	
Modbus input flags (MBiFi)	
Modbus reference flags (MBiRi)	
Filtered values (FVi)	
Integer values (IiVi)	
Real constant (RCi)	
Logbook	chapter 7.4
System status	chapter 7.5.1
System info	chapter 7.5
Timemeter	chapter 7.5
Parameter	chapter 6
Measuring components	chapter 6.1
Global definitions	
Measuring screen	chapter 6.2
Measuring Screen x	
I/O	chapter 6.5
Hardware plan	
Data	
- External data	
- OPC outputs (OPCOi)	
- Modbus values (MBVi)	
- Modbus input values (MBiVi)	
- Modbus input flags (MBiFi)	
- Modbus reference flags (MBiRiFi)	
Sequence control programs	chapter 6.4
Sampling point program (MPP)	
Temperature control	chapter 6.6.1
Pressure control	chapter 6.6.2
Flow rate	chapter 6.6.3
O2 sensor	chapter 6.6.4
Logbook	chapter 6.6.5
Instrument display	chapter 6.6.6
Device	chapter 6.6.7
Emitter	chapter 6.6.8
Modbus	chapter 6.6.7
Adjustment	chapter 6.5.4
Parameter	chapter 6
Concentrations	
Adjustment factors	
Start times	
Manual adjustment	chapter 6.3
Automatic adjustment	chapter 6.3
Maintenance	chapter 8
Tests	chapter 8.1
Digital inputs	
Digital outputs	
Operating states	chapter 8.2
System maintenance	chapter 8.3
Service log	chapter 8.5
Restart system	chapter 8.4
Confirm active messages	chapter 8.6
Replacing the analyzer	chapter 8.8
Replacing the electronics	chapter 8.9
Loading/saving the parameters	chapter 8.7

5 Measuring screens and data storage

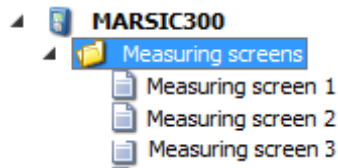

Only the configured Measuring screens are shown.
 ▶ Double-click the desired Measuring screen

Figure 48: Menu Measuring Screens

- Configuring Measuring screens: see "Measuring screens", page 47.
- Scaling Measuring screens.

5.1 Measuring screen

The Measuring screen is shown as measured value box, bar graph or line writer depending on the configuration.

Measured value box

Here, the measured values are shown in numeric format.

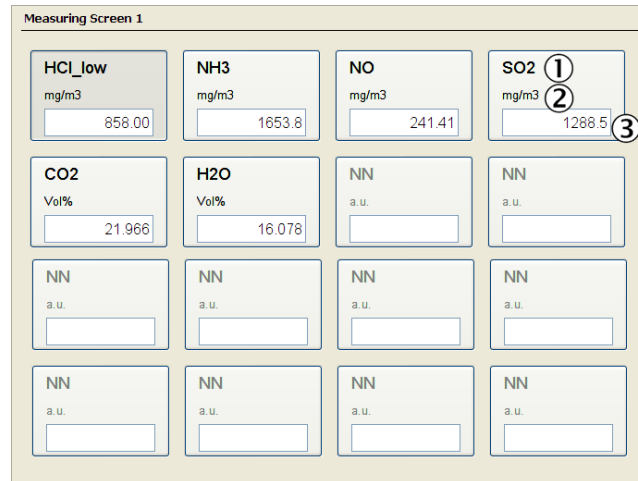

- ① Component
- ② Unit
- ③ Measured value

Figure 49: Menu Measuring Screen/Measuring Screen 1 ... x

Bar graph

Here, the measured values are shown as a bar graph.

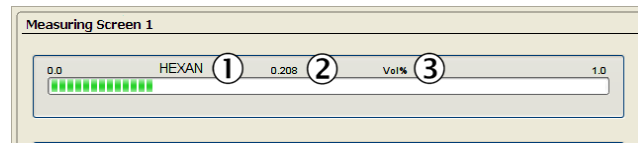

- ① Component
- ② Unit
- ③ Measured value

Figure 50: Bar graph

Line Writer and data storage

Here, the measured values are shown in numeric format as measured value box and in a time chart.

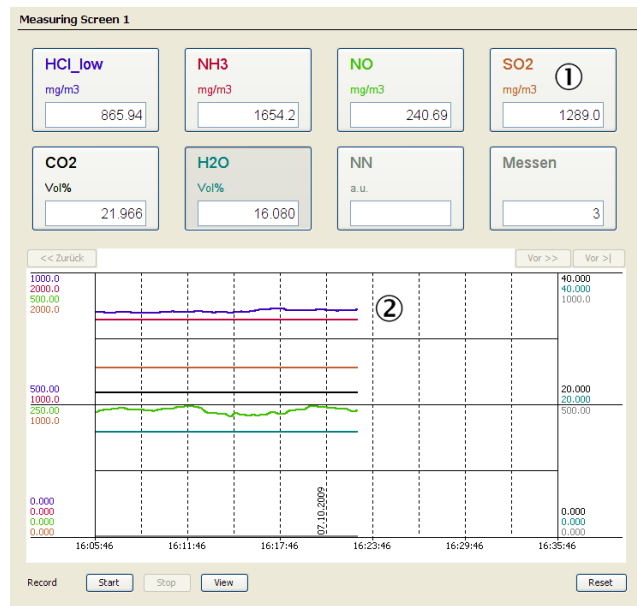

- ① Component
- ② Line Writer - shows the activated measured values (see under “Scaling Measuring screens”). The Line Writer first starts the display when it is called up for the first time. Changing the user level deletes the history of the line display.



Figure 51: Line Writer

5.2 Data storage function

- ▶ **Start:**
Start data storage.
Data that have been configured are stored (independent of the graphic representation).
Maximum 65536 entries per curve are stored in a file and then a new file created automatically (with an incremental index).
▷ A dialog field appears above the line diagram to enter a target file name (.txt):

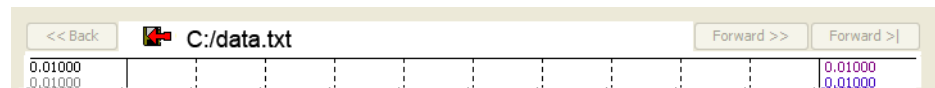

Figure 52: Storing the recording

- ▶ **Stop:**
Stop recording.
- ▶ **View:**
View recorded data.
A dialog field appears to select the file with the stored values.
The following then appears above the line diagram:

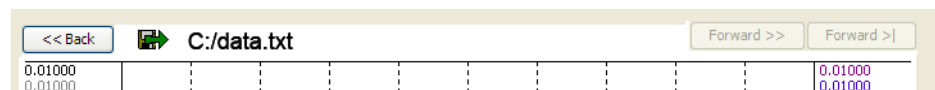

Figure 53: Loading the recording

- ▶ **Reset:**
Delete all line displayed (no effect on data storage).

Scaling Measuring screens

Tap on a display to call up a screen for scaling:

Measuring Screen 1

Color selection: black ①

Number format: -5 ②

Scale start: -0.01 ③

Scale end: 0.01 ④

Active: ⑤

Save Cancel

Figure 54: Menu Scaling

- ① Font color (Line Writer colors are predefined)
- ② Measuring screen precision
Example:
-2: 123.45
-1: 1234.5
0 : 12345
1 : 123450
- ③ Scale start value
- ④ Scale end value
(for Line Writer: for y-axis)
- ⑤ Line display active / not active
(for Line Writer)

6 Parameterization

6.1 Measuring components

Global definitions

This menu displays the global device information (e.g.: number of filter wheels, number of activated components).

Global definitions																				
Active measuring component	1	<input checked="" type="checkbox"/>	2	<input checked="" type="checkbox"/>	3	<input checked="" type="checkbox"/>	4	<input checked="" type="checkbox"/>	5	<input checked="" type="checkbox"/>	6	<input checked="" type="checkbox"/>	7	<input checked="" type="checkbox"/>	8	<input checked="" type="checkbox"/>	9	<input checked="" type="checkbox"/>	10	<input checked="" type="checkbox"/>
Reference energy failure	<input type="text" value="1"/> %																			

Figure 55: Menu Parameterization/Measuring component/Global Definitions

- ① Active measuring components. Checkmark: Active
- ② Internal use: Error threshold of reference energy as from which a message is generated.

Definition of measuring components

This menu displays the setting for the respective measuring component.

This menu only serves as information.

Definition of component 1	
Component name	<input type="text" value="SO2LO"/>
Unit of concentration of calibration	<input type="text" value="ppm"/>
Conversion of unit of concentration	<input type="checkbox"/>
Averaging time [s]	<input type="text" value="60"/>
Monitored limits	
Reference energy warning	<input type="text" value="10"/> %
Zero drift	<input type="text" value="6"/> %
Adjustment Ref.point	<input type="text" value="10"/> %
Upper range value	<input type="text" value="30"/> <input type="text" value="ppm"/>

Figure 56: Menu Parameterization/Measuring components/Definition of components

6.2 Measuring screens

Up to 8 Measuring screens can be configured and displayed:

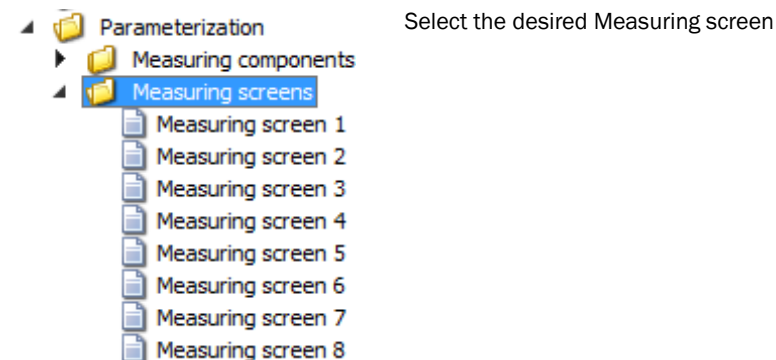
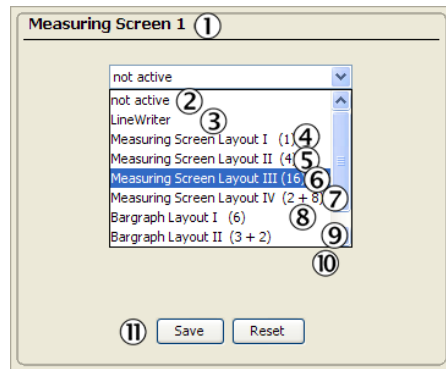

Figure 57: Menu Tree Parameters/Measuring Screens in SOPAS ET

Double-clicking a Measuring screen opens a screen in which the Measuring screen can be configured:



- ① Selected Measuring screen
- ② Do not display the Measuring screen
- ③ Line Writer (see example below)
- ④ 1 measured value box
- ⑤ 4 measured value boxes
- ⑥ 16 measured value boxes (see example below)
- ⑦ 2 large, 8 small measured value boxes
- ⑧ 6 bar graphs (see below)
- ⑨ 3 bar graphs + 2 measured value boxes
- ⑩ 3 bar graphs + 8 measured value boxes (hidden)
- Ⓜ Click "Save" to store

Figure 58: Menu Measuring Screens - Layout selection

Measured value box

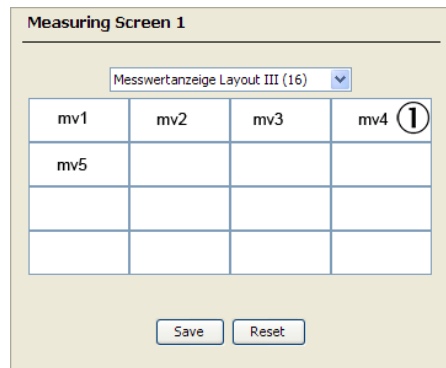

- Example: Measuring screen 1 with layout III (16 measured value boxes)
- ① ▶ Enter desired names (tags). MAR-SIC300 tags: see "Tags (variable names)", page 100
- Scaling the measured value box: see "Measuring screen", page 44

Figure 59: Menu Measuring Screens - Example layout

The Measuring screen now looks like this.

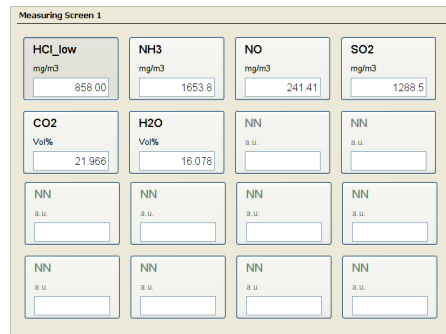

The component names and units can be, for example, from the factory settings (e.g. RVi) the source of a filter (e.g. FVi) or from the analyzer.

Figure 60: Menu Measuring Screens - Component names

Bar graph

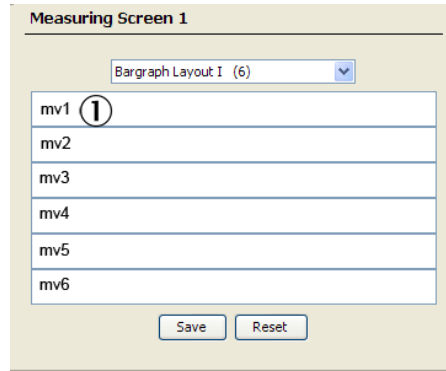

Figure 61: Menu Measuring Screens - Bar graph

The Measuring screen then looks like this:

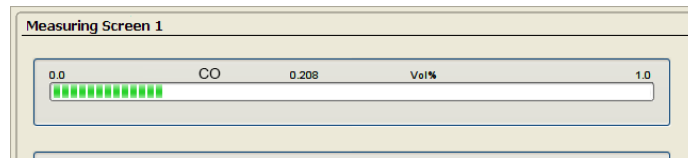

Figure 62: Bar graph - example

- Example: Measuring screen 1 with bar graph layout I (6 bars)
- ① ► Enter desired names (tags). MAR-SIC300 tags: see "Tags (variable names)", page 100
- Scaling the measured value box: see "Measuring screen", page 44

Line Writer

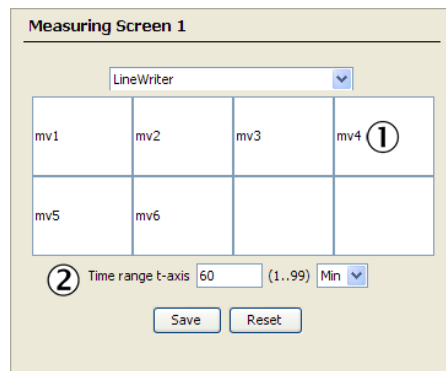

Figure 63: Menu Measuring Screens - Tags

The Measuring screen then looks like this:

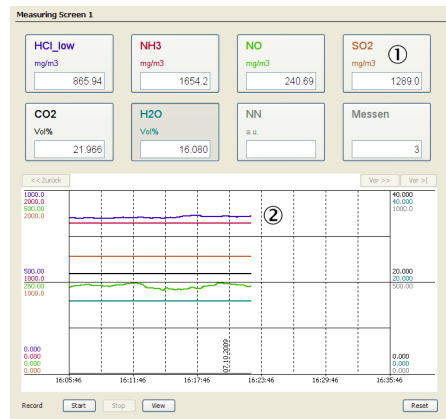

Figure 64: Menu Measuring Screens - Line Writer

- ① ► Enter desired names (tags). Scaling the measured value box: see "Measuring screen", page 44
- ② Scaling the time axis [sec, min or hrs], scaling the y-axis: see "Measuring screen", page 44

- ① Measured value box
- ② Line Writer

6.3 Adjustment functions

Start times

Menu: Adjustment/Parameter/Start times

This menu displays the start times of the “Cyclic triggers (CT1 .. CT16)”.

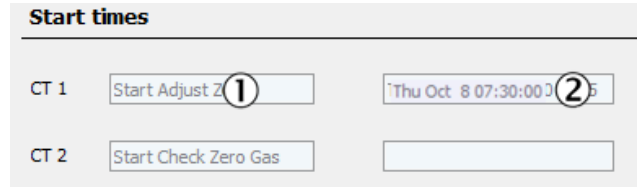

- ① Cyclic trigger name
 - ② Next start time
- Deactivation via operator panel or menu: Parameter/Variables and functions/Cyclic trigger (CTi)

Figure 65: Menu Start times

Manual adjustment

Menu: Adjustment/Manual adjustment

Further information, see “MARSIC300 Operating Instructions”

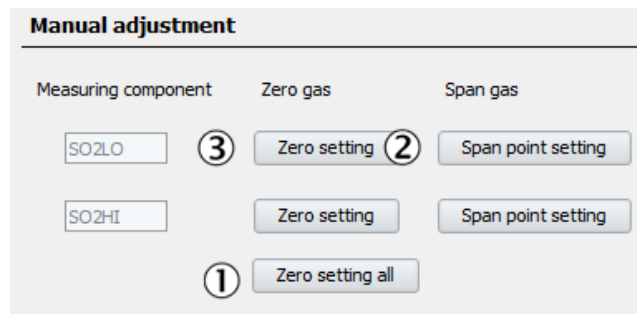

- ① Measured value of this component is set to zero
- ② Measured value of this component is set to the nominal concentration of the test medium
- ③ Measured values of all components listed above are set to zero

Figure 66: Menu Manual adjustment

Automatic adjustment

Menu: Adjustment/Automatic adjustment

Further information, see “MARSIC300 Operating Instructions”

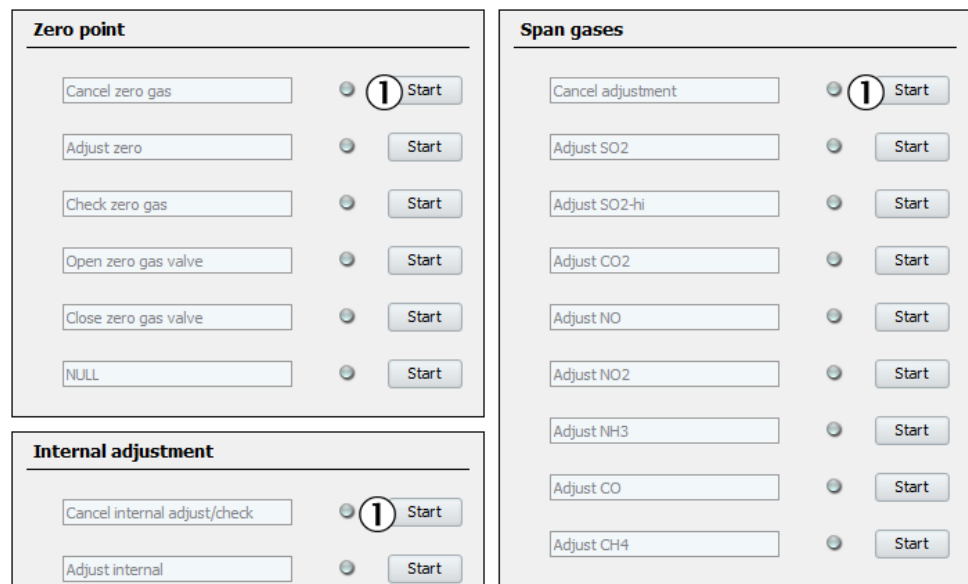

Figure 67: Menu Automatic adjustment

- ① Start adjustment of program displayed

The available programs are system-specific: see System documentation.

Parameter

6.3.1.1 Concentrations of test gases

Menu: **Adjustment/Parameter/Concentrations**

This menu displays the concentrations of the span gases and internal adjustment filter.

The concentrations of the test gases can be set.

Concentrations				
Measuring component	Unit	Concentration		Nominal absor.
		Span gas	Internal adjust.	Internal adjust.
SO2LO	ppm	15	24	0.021000
SO2HI	ppm	0	1600	0.058000
Extern Component	Unit	Concentration span gas		
NULL	NULL	0		
NULL	NULL	0		

- ① Enter the concentration of the test medium
- ② Only internal significance

Figure 68: Menu Concentrations

6.3.1.2 Adjustment factors

Menu: **Adjustment/Parameter/Adjustment factors**

This menu serves to set the correction factors (adjustment filter wheel optional).

- The measured value is computed with both adjustment factors.
- Factor "Internal adjust." is set automatically to "1.000" when factor "Span gas" is changed.
- Checkmark "Active": This measuring component is computed.

Measuring component	Span gas			Internal adjustment		
	actual value	active	Set value	actual value	active	Set value
SO2LO	1.000	<input checked="" type="checkbox"/>	1	1.020	<input checked="" type="checkbox"/>	1.02
SO2HI	1.000	<input checked="" type="checkbox"/>	1	0.992	<input checked="" type="checkbox"/>	0.992

Figure 69: Menu Adjustment factors

- ① Display: Current factor
- ② Input: New factor
- ③ Confirm: Use new factor

6.3.1.3 Start times

Menu: **Adjustment/Parameter/Start times**

This menu displays the start times of the "Cyclic triggers (CT1 .. CT16)".

Start times	
CT 1	Start Adjust Z [] [Thu Oct 8 07:30:00]
CT 2	Start Check Zero Gas []

- ① Cyclic trigger name
 - ② Next start time
- Deactivation via operator panel or menu: Parameter/Variables and functions/Cyclic trigger (CTi)

Figure 70: Menu Start times

6.3.1 Manual adjustment

Menu: Adjustment/Manual adjustment

Further information, see "MARSIC300 Operating Instructions"

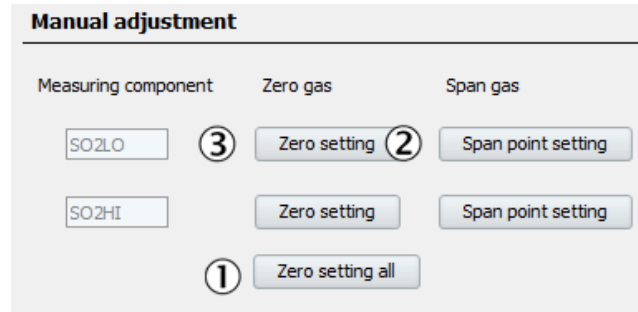

- ① Measured value of this component is set to zero
- ② Measured value of this component is set to the nominal concentration of the span gas
- ③ Measured values of all components listed above are set to zero

Figure 71: Menu Manual adjustment

6.3.2 Automatic adjustment

Menu: Adjustment/Automatic adjustment

Further information, see "MARSIC300 Operating Instructions"

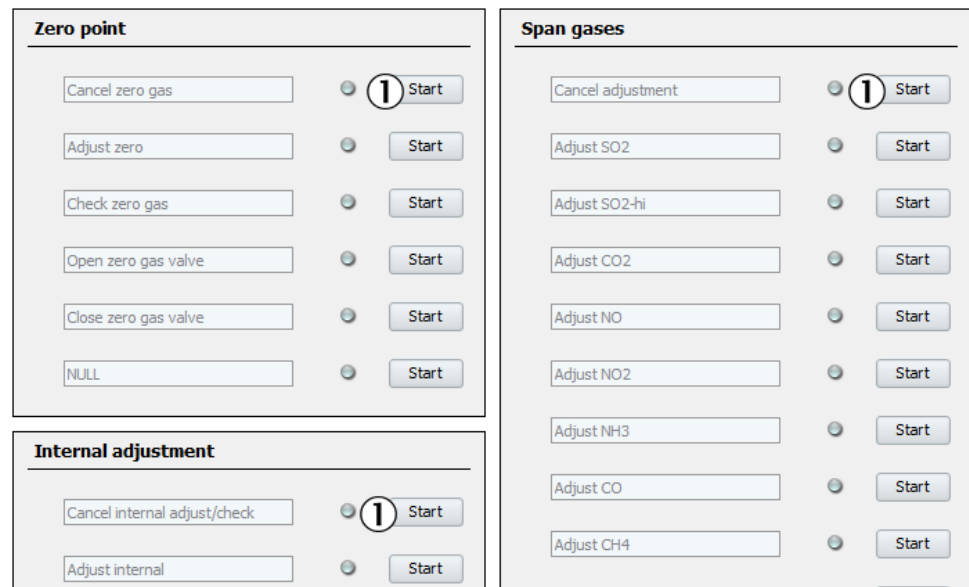

Figure 72: Menu Automatic adjustment

- ① Start adjustment of program displayed
The available programs are system-specific: see System documentation.

6.4 Measuring point switchover / Sequence control program

Sampling point program

Menu: Parameterization/Sequence control program/Sampling point program

This menu serves to configure "measuring at several sampling points".



CAUTION

The programs are automatically controlled.

The device no longer measures correctly when a program is interrupted with Start/Pause/Stop/Continue.

- ▶ Only use these functions when you are sure you can assess the consequences.

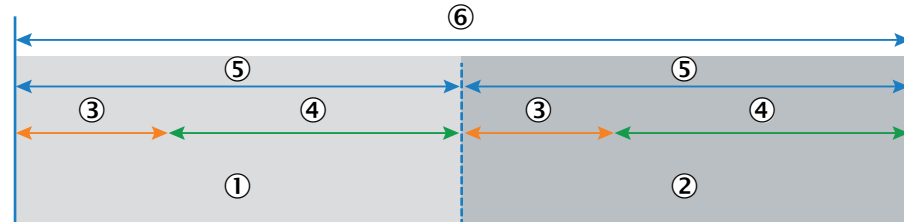

Figure 73: Measuring point switchover - diagram

- ① Measuring point 1
- ② Measuring point 2
- ③ Hold time
- ④ Active
- ⑤ Duration
- ⑥ Cycle time

Cycle time

The complete defined measuring cycle including measuring point switchover is completed within the cycle time.

Duration

The time during which a measuring point is active and measuring (including run-in time after measuring point switchover).

Hold time

After measuring point switchover: The time in which the last valid measured value of the measuring point is held until the new measuring point has run-in (purge processes etc.).

The hold time can be entered individually for each measuring point and serves, for example, to control the release of the measured value to Modbus or similar.

Active

Valid measured values of the active measuring point are available after the run-in time.

Figure 74: Menu Sampling point program (MPP)

- ① Display: Internal tag to enable the sampling point program
- ② Display: Run-time for the current sampling point
- ③ Start the sampling point program
- ④ Interrupt the sampling point program (pause)
- ⑤ Display: Active sampling point
- ⑥ Display: Index of active sampling point

- ⑦ Cancel the sampling point program
- ⑧ Continue the sampling point program after "Pause"
- ⑨ Input: Number of sampling points
- ⑩ Minimum measuring time per sampling point
- ⑪ Checkmark: Fixed cycle time 285 s ("DeSOx time")
- ⑫ Checkmark: Fixed cycle time from "Cycle time"
- ⑬ Checkmark: Fixed sampling point time
- ⑭ Input: Cycle time

DeSOx-Time (⑪)

The DeSOx-Time is based on Guideline MEPC.259(68). This requires that each measuring point must be measured once within 4:45 minutes (285 seconds).

To enter in the menu below: Subtract the hold times from the 4:45 minutes and divide the remaining time by the number of measuring points. For example: For 2 measuring points with the same hold time, each measuring point is active for 142 seconds.

This can be used, for example, to control the release of the measured value on Modbus.

Fix.Cycle-Time (⑫)

The "Fix.Cycle-Time" corresponds to the "DeSOx-Time", however the cycle time is not specified fixed but can be entered explicitly (see menu above).

Fix.Msp-Time (⑬)

Measuring on each measuring point continues for the time specified under "Duration" in the menu.

This means different measuring times can be defined per measuring point. If the duration set is shorter than the "hold time + minimum measuring time", the duration is automatically set to this time. The following is also valid - the total of "hold times + the minimum measuring time" per measuring point may not be longer than the cycle time. Otherwise the cycle time is increased accordingly.

Sampling point program (MPP)

Save Mark Edit Copy Replace Next

Sampling point	Name	Order	Duration [s]	Hold time [s]	Active
1	① Sampling Point 1	1	0	45	⑥
2	② Sampling Point 2	2	0	45	

Figure 75: Measuring point program - menu description

- ① Sampling point index
- ② Sampling point name
- ③ Sampling point sequence
- ④ Measuring time at the sampling point including run-in times
- ⑤ Run-in time
- ⑥ Checkmark active: Sampling point active

Sampling point program (MPP)

Sampling point: 1 ① ② Active

Name: ③ Sampling Point 1 Duration [s]: ④ 0 Hold time [s]: ⑤ 45

Order: ⑥ 1

Cancel < >

Figure 76: Measuring point program - setting options

- ① Display: Sampling point index
- ② Checkmark: Sampling point active
- ③ Sampling point name
- ④ Overall duration at the sampling point

- ⑤ Run-in time
- ⑥ Position in the sequence of the sampling point program



NOTICE

The green arrow (load all parameters) must be pressed after making changes in order to see the effect of the changes for both measuring points. This then updates the data in the Table accordingly.



Figure 77: Load parameters - button

6.5 Data interfaces / IO

Menu: **Parameterization/I/O**

This menu displays the data interfaces.

Hardware Plan

Menu: **Parameterization/I/O/Hardware plan**

CAN bus address x

Displays the I/O modules present in the selected CAN bus gateway.



NOTE

The sequence of the specified modules must match the sequence of the plugged in modules (starting at the gateway).

CAN Bus Adresse		CAN Bus address 0 (N1)						
Sichern		Save	Mark	Show	Copy	Replace	Next	Weiter
Index ①	Index	Plugged-In ②	Type ③					
1	1	<input type="checkbox"/>	NULL					
2	2	<input type="checkbox"/>	NULL					

Figure 78: Menu CAN Bus address

- ① Consecutive number of module.
- ② Checkmark: Module is plugged in.
- ③ I/O module type.

Data

Menu: **Parameterization/I/O/Data**

6.5.1 Digital inputs

Menu: **Parameterization/I/O/Data/External data/Digital inputs**

This menu displays the digital inputs.

Table 7: Digital inputs

Name	Remark
Index	Consecutive number of the digital input (DI1, DI2, ...).
Module	Topographic addressing (see "Data interfaces / IO", page 55). Generated automatically.
Name	Set fixed.
Inverted	Checkmark: Read in inverted.

6.5.2 Digital outputs

Menu: **Parameterization/I/O/Data/External data/Digital outputs**

This menu displays the digital outputs.

Table 8: Digital outputs

Name	Remark
Index	Consecutive number of the digital outputs (DO1, DO2, ...).
Module	Topographic addressing (see "Data interfaces / IO", page 55). Generated automatically.
Source	Tag.
Inverted	Checkmark: Output inverted.

6.5.3 OPC outputs

Menu: **Parameterization/I/O/Data/OPC outputs**

This menu assigns data from the MARSIC300 to the OPC output values.

Table 9: OPC outputs

Name	Remark
Index	Consecutive number of the OPC output value.
Source	Tag.

6.5.4 Modbus

MARSIC300 runs as "Slave".

The Modbus process communicates with the device process via shared memory.

A semaphore secures the access on both sides.

The Modbus process communicates with a connected device (e.g., evaluation computer) via TCP/IP.

Register assignment: see "Device status (Discrete Inputs [1xxxx], Function Code 02)", page 90

Modbus values and Modbus flags: see "Data interfaces / IO", page 55

This menu serves to configure Modbus communication.

Menu: **Parameterization/Modbus**

The screenshot shows the 'Modbus' configuration window. It contains the following elements:

- Slave Adresse:** A text input field with the value '1' and a circled '1' next to it.
- Register swap:** A dropdown menu showing 'AB_CD' and a circled '2' next to it.
- TCP port:** A text input field with the value '502' and a circled '3' next to it.
- Simulation Mode:** A checkbox that is currently unchecked, with a circled '4' next to it.
- Low S:** A text input field with the value '0' and a circled '5' next to it.
- High S:** A text input field with the value '1000' and a circled '6' next to it.
- Activate configuration:** A button with a circled '7' next to it.

Figure 79: Menu Modbus

- ① Slave address of MARSIC300
- ② Register swap
- ③ TCP port (standard: 502)
- ④ Simulation mode in which the values in registers 4200 et seq. are written scaled to registers 4000 et seq.
- ⑤ Lower measured value limit for Simulation mode
- ⑥ Upper measured value limit for Simulation mode

- ⑦ Modbus restart with acceptance of the settings

Modbus values (MBVi)

Menu: **Parameterization/I/O/Data/Modbus values**

The Modbus values determine which values are stored in the Modbus.

Edit window:

Figure 80: Menu Modbus values

- ① Index: Sequential numbering of the Modbus values
- ② Active Modbus values: Checkmark: Active
- ③ When the checkmark for “Auto Name/Unit” is set, the name and unit of the tag specified in the source are automatically used.
- ④ With Autostatus, the system status is used automatically as status of the value
- ⑤ When the checkmark for scaling is activated, this value is scaled. It is scaled in register range 4000 et seq. (Holding register) to 0 ... 10000.
- ⑥ Value name
- ⑦ Measuring range start
- ⑧ Measuring range end
- ⑨ Physical unit of value
- ⑩ Source: Tag for which the value is to be used.
- ⑪ Data type (Real/Integer/Bool) (2 registers)
- ⑫ The status of the tag named here is used when Autostatus is not activated.
- ⑬ Checkmark: Use standard range register 4000 et seq. (Holding register)
- ⑭ Position: Offset in respective range
- ⑮ Checkmark: Use standard range register 1000 et seq.
- ⑯ Register type (Holding/Input/Coil/DI)
- ⑰ Checkmark: Use standard range register 2000 et seq.
- ⑱ Checkmark: Use standard range register 3000 et seq.

Modbus input values (MBVi)

Menu: **Parameterization/I/O/Data/Modbus input values**

Serves to assign a name, unit and data type to the measured values stored by the Master in the Holding register, whereby i is the index. Two registers incrementing from the offset are used per measured value. A status is not considered.

Edit window:

Figure 81: Menu Modbus input values

- ① Line (Index)
- ② Input value name
- ③ Physical unit of input value
- ④ Data type (Real/Integer/Bool)

Modbus input flags (MBIFi)

Menu: **Parameterization/I/O/Data/Modbus input flags**

Serves to assign a name to the Bool values (flags) stored by the Master in the Coils.

Edit window:

Figure 82: Menu Modbus input flags

- ① Line (Index)
- ② Input flag name

Modbus reference flags (MBIRFi)

Menu: **Parameterization/I/O/Data/Modbus Reference flags**

Serves to assign the reference sources (test gases / internal adjustment) to individual values to so that it can be seen what is currently active.

Edit window:

Figure 83: Menu Modbus reference flags

- ① Index
- ② Reference flag name
- ③ Source: Tag for which the value is to be used.

6.6 Device parameters

6.6.1 Temperature control

Menu: **Parameterization/Temperature control**

This menu serves to set the unit of the temperature display.

All other displays serve as information.

Temperature control global

Unit for all temperature-displays ①

EK-LPMS01 Max.

EK-LPMS03 Max.

EK-LPMS02 Max.

- ① Adjustable: Unit of temperature display [°C, K, °F]

Figure 84: Menu Temperature control global

6.6.2 Pressure control

Menu: **Parameterization/Pressure control**

This menu serves to view the parameters for pressure control.

6.6.3 Flow rate

Menu: **Parameterization/Flow rate**

This menu serves to configure the warning threshold for the gas flow rate.

Flow monitoring

Active ①

Min. flow ② l/h

Min. flow warning ③ l/h

Max. flow warning ④ l/h

Max. flow ⑤ l/h

- ① Checkmark: Monitoring active
- ② Input: Minimum flow rate error message (default value: 100 l/h)
- ③ Input: Minimum flow rate warning threshold (default value: 130 l/h)
- ④ Input: Maximum flow rate warning threshold (default value: 600 l/h)
- ⑤ Input: Maximum flow rate error message (default value: 1000 l/h)

Figure 85: Menu Flow monitoring

6.6.4 O2 sensor

Menu: **Parameterization/O2 Sensor**

This menu serves to view the configuration of the O₂ sensor.

6.6.5 Logbook

Menu: **Parameterization/Logbook**

This menu serves to configure the logbook.



Changing the setting deletes all entries.

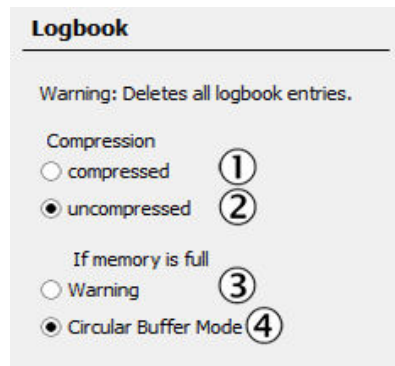

Figure 86: Menu Logbook

If an error occurs:

- ① An error counter is incremented.
- ② The error message is stored.

When the logbook is full:

- ③ Message "Logbook error" is output and no further entries are stored.
- ④ The current entries overwrite the oldest entries. A relevant message is not output.

6.6.6 Instrument display

Menu: **Parameterization/Instrument display**

This menu serves to configure how the instrument display shows information:

- The Measuring screen.
- The password for the operator panel on the display.
- If parameters have been changed and the Measuring screen is being shown on the instrument display: The display on the instrument display must be reinitialized so that the changes can be shown on the instrument display.
 - 1 Press the menu-dependent button "Menu" on the device.
 - 2 Then press "MEAS".

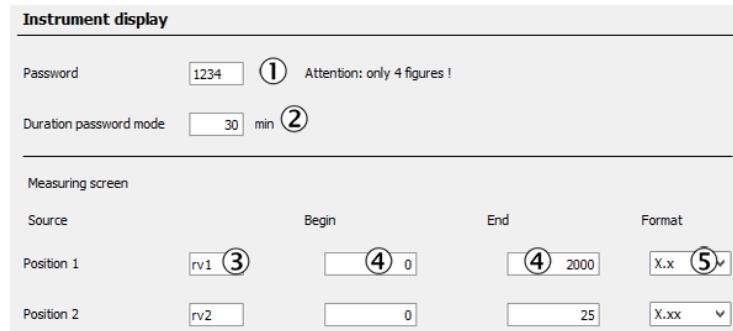

Figure 87: Menu Device display

- ① Password, comprising 4 digits. (Information: Is first used after a hardware reset ([Restart](#))).
- ② Validity duration of the password-protected level. (Information: Is first used after a hardware reset ([Restart](#))).
- ③ Configuration (see "[Tags \(variable names\)](#)", page 100) of the Measuring screen.
- ④ Start and end values of the display range of the bar and line charts. Start value must be lower than the end value (no plausibility check during input)..
- ⑤ Counter format of the display: Number of decimal places.

6.6.7 System

Menu: **Parameterization/System parameters**

This menu serves to display and change system parameters.

System parameter

System name ①

Serial number

Serial number cell

Allow IP configuration ② Language ③

④ Actual system time

Caution: IO will be reset!

Figure 88: Menu Device parameters

- ① System name
- ② Checkmark: The IP configuration of the MARSIC300 can be changed in SOPAS ET.
- ③ Device language.
Accept with "Initialize" (see "Setting operating states", page 69)
- ④ Use PC time on MARSIC300.

6.6.8 Emitter

Menu: Parameterization/Emitter

This menu serves to view the parameters for the emitter.

7 Diagnosis

7.1 Control values adjustment, sensors and signals

Zero drift

Menu: **Diagnosis/Control values/Zero drift**

This menu displays the drift "with zero gas" (since the last drift "reset") and can be reset.

This drift is recalculated as from the relevant adjustment.

Figure 89: Menu Zero drift

- ▶ Reset: Reset zero drift
Both "Reset" have the same effect.

Span gas drift

Menu: **Diagnosis/Control values/Drift span gas**

This menu displays the drift "with test gas" (since the last drift "reset") and can be reset.

This drift is recalculated as from the relevant adjustment.

Measuring component	Unit	Nominal	actual	last	first	Last deviation	Total deviation
SO2LO	ppm	15.00	-37.95	95.99	20.00	139.53 %	289.73 %
SO2HI	ppm	0.00	-3.30	-3.30	-3.30	0.00 %	0.00 %

Figure 90: Menu Test gas drift

- ▶ Reset: Reset zero drift.

Internal adjustment drift

Menu: **Diagnosis/Control values/Drift internal adjustment**

This menu displays the drift "with internal standard" (this means without test gas) (since the last drift "reset").

Measuring component	Unit	Nominal	actual	last	first	Last deviation	Total deviation
SO2LO	ppm	24	23.52	23.57	24.00	0.21 %	1.99 %
SO2HI	ppm	1600	1612.47	1612.54	1600.00	0.00 %	0.78 %

Figure 91: Menu Drift - internal adjustment

Reference energy

Menu: **Diagnosis/Control values/Reference energy**

This menu displays the current reference energy (as percentage) and can be reset.

The energy is automatically monitored.

If a limit value is underflown (default setting: 60 %), the MARSIC300 switches to classification "Maintenance request".

Measuring component	Reference energy
SO2LO	96.18 %
SO2HI	96.84 %

► Reset: Reset reference energy

Figure 92: Menu Reference energy

Intensity

Menu: **Diagnosis/Control values/Intensity**

This menu displays intensities (energies) and amplification levels of the measuring components.

Let SICK Customer Service evaluate this information.

Measuring component	Measuring filter	Reference filter	Meas.adjust filter	Ref.adjust filter
SO2LO	4510.7	1563.4	5746.1	5744.5
SO2HI	1984.4	1794.8	1788.2	1796.2

Figure 93: Menu Intensity

7.2 Sensor values

Menu: **Diagnosis/Sensor values**

This menu displays the diverse internal device sensor values:

- Temperatures
- Pressures
- Flow rate
- Cell
- O₂ sensor
- Emitter
- Motors
- Hardware

These values serve as information.

A message is output when a value is outside its nominal range.

7.3 Signals

Menu: **Diagnosis/Signals**



NOTE

Configuration of signals listed below: see "Data interfaces / IO", page 55 and following.

External signals

Digital signals

Menu: **Diagnosis/Signals/External signals/Digital signals**

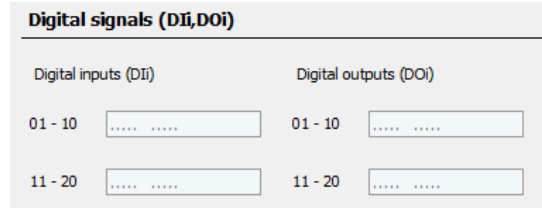

This menu displays the current state of the digital signals (DIi, DOi, limit values)

Digital values:
 . = off (0)
 I = on (1)

Figure 94: Menu Digital signals

Measuring signals

Menu: **Diagnosis/Signals/Measuring signals**

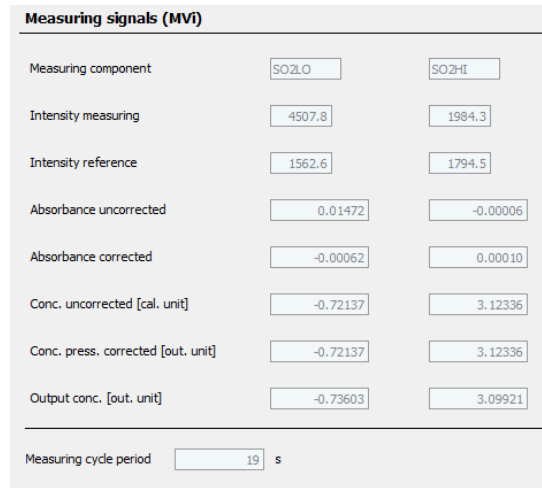

This menu displays the measuring signals.
 Let SICK Customer Service evaluate these signals.

Figure 95: Menu Measuring signals

Internal signals

Menu: **Diagnosis/Signals/Diagnosis internal**

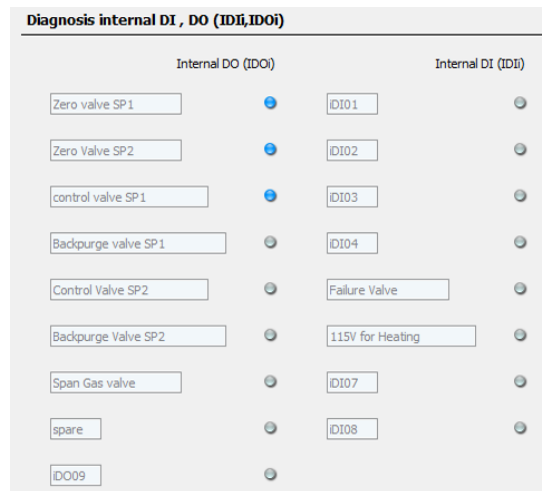

This menu displays the signals.
 Let SICK Customer Service evaluate these signals.

Figure 96: Menu Internal signals

Boolean values

Menu: Diagnosis/Signals/Boolean values

Boolean values (BVLBI)					
Boolean values (BVi)					
01 - 10	101 - 110		201 - 210
11 - 20	111 - 120	211 - 220
21 - 30	121 - 130	221 - 230
Limit values (Lli)					
01 - 10	11 - 20	21 - 30

This menu displays the Boolean values (BVi) and limit values (Lli).

Figure 97: Menu Boolean values

Real values

Menu: Diagnosis/Signals/Real values

Real values (RVi)			
RV 1	-0.354	RV 11	0
RV 2	-0.01	RV 12	0
RV 3	1.429	RV 13	0
RV 21	0	RV 22	0
RV 31	0	RV 32	-749.9
RV 23	0	RV 33	749.9

This menu displays the current real values (RVi).

Figure 98: Menu Real values

Modbus values

This menu shows the current Modbus values and Modbus flags

- Modbus values
- Modbus input values
- Modbus input flags
- Modbus reference flags

Further information on Modbus: see "Modbus", page 56 and see "Data interfaces / IO", page 55

Filtered values

Menu: Diagnosis/Signals/Filtered values

Filtered values (FVi)			
FV 1	-0.388	FV 17	0
FV 2	-0.018	FV 18	0
FV 3	1.424	FV 19	0
FV 33	0	FV 49	0
FV 34	0	FV 50	0
FV 35	0	FV 51	0

This menu displays the current filtered values (FVi).

Figure 99: Menu Filtered values

Integer values

Menu: Diagnosis/Signals/Integer values

Integer values (IVi)			
IV 1	0	IV 11	0
IV 2	24	IV 12	0
IV 3	0	IV 13	0
IV 21	0	IV 22	0
IV 31	400	IV 32	200
IV 23	0	IV 33	20

This menu displays the current integer values (IVi).

Figure 100: Menu Integer values

Real constants

Menu: Diagnosis/Signals/Real constants

Real constant (RCi)			
RC 1	<input type="text" value="0"/>	RC 11	<input type="text" value="0"/>
RC 2	<input type="text" value="0"/>	RC 12	<input type="text" value="0"/>
RC 3	<input type="text" value="0"/>	RC 13	<input type="text" value="0"/>
RC 21	<input type="text" value="0"/>	RC 22	<input type="text" value="0"/>
RC 31	<input type="text" value="0"/>	RC 32	<input type="text" value="0"/>
RC 23	<input type="text" value="0"/>	RC 33	<input type="text" value="0"/>

This menu displays the current real constants (RCi).

Figure 101: Menu Real constants

7.4 Logbook

The logbook records warnings, value overflows and underflows as well as errors and serves to document and reconstruct occurring events. The logbook can be saved with SOPAS ET (see "Saving parameters", page 40) and, for example, sent to SICK Customer Service per e-mail.

Maximum number of entries: 6000.

(Representation: uncompressed data storage)

No.	Dev	Classification	Date start	Time start	Date stop	Time stop
1	NO	U	15/08/17	08:41:21	15/08/17	08:41:58
2	System	X	15/08/17	08:40:53	15/08/17	08:40:55
3	System	X	15/08/17	08:40:51	15/08/17	08:40:52

Figure 102: Menu Diagnosis/Logbook

Table 10: Logbook - Menu legends

Name	Remark
	Logbook fill level in %. If the font is red: The logbook is full. Warning mode: No further entries are made. Ring buffer mode: The oldest entries are overwritten.
	Data storage: Symbol not crossed out: Compressed. Symbol crossed out: Uncompressed. Significance and default setting: see "Logbook", page 59
	Ring buffer mode warning mode, significance and default setting: see "Logbook", page 59
①	Number of entries of selected filter.
②	Only filtered messages are shown. <ul style="list-style-type: none"> • Failure (active) • Failure (all) • Maintenance request (active) • Maintenance request (all) • Uncertain (active) • Uncertain (all) • Other (active) • Other (all) • All active • All
③	Attention: All logbook entries in MARSIC300 are deleted
④	All entries selected with the filter (see in the Table further above) are stored on the PC as log file in C:\Own files. Format: CSV (comma-separated list). Viewable in, e.g., EXCEL.

Name	Remark
⑤	To update the display: Click the display.
⑥	Scroll to older entries.
⑦	Scroll to current entries.
	Consecutive number of the message. Red LED: Message still pending. Green LED: Message no longer pending.
⑧	Triggering unit: System, measured value name (sample gas component), subassembly, Evaluation module.
⑨	Number of times the error has occurred. Significance and default setting: see "Logbook", page 59 Only with "compressed data storage".
⑩	Logbook message (error messages see MARSIC300 Operating Instructions).
⑪	F = Failure M = Maintenance request C = Check (function control / maintenance) U = Uncertain X = Extended
⑫	Format: yy-mm-dd For "uncompressed": When message occurred. For "compressed": Last time message occurred
⑬	Format: hh:mm:ss For "uncompressed": When message occurred. For "compressed": Last time message occurred
⑭	Format: yy-mm-dd For "uncompressed": When message was deleted For "compressed": Last time message was deleted.
⑮	Format: hh:mm:ss For "uncompressed": When message was deleted For "compressed": Last time message was deleted.

7.5 System info

System info

Menu: **Diagnosis/System info**

This menu displays system status (see “MARSIC300 Operating Instructions”) and system information.

- Serial number
- IP address
- Software version

7.5.1 System status

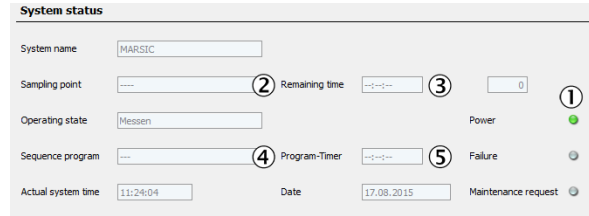

Figure 103: Menu Diagnosis/System status

- ① LEDs in accordance with the operator panel
- ② With measuring point switch-over: Current measuring point
- ③ With measuring point switch-over: Remaining time until measuring point switchover
- ④ Name of current sequence control program
- ⑤ Remaining time of current sequence control program

7.5.2 System info

System info

Menu: Diagnosis/System info

This menu displays system status (see “MARSIC300 Operating Instructions”) and system information.

- Serial number
- IP address
- Software version

7.5.3 Timemeter

This menu serves to view diverse operating hours counters.

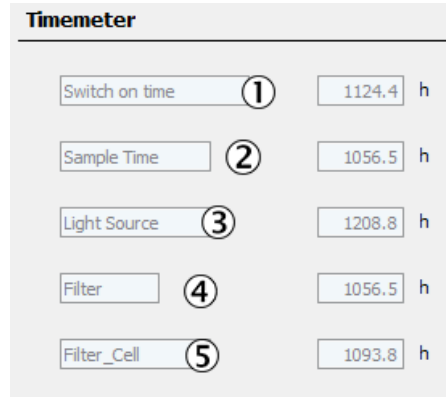

Figure 104: Menu Diagnosis/Timemeter

- ① Operating hours
This counter shows the total operating time (“Power on”) of the Analyzer module.
- ② Measuring duration
This counter shows the total time sample gas was fed.
- ③ Operating time of the light source
- ④ Operating time of the filter of the gas sampling system
- ⑤ Operating time of the cell inlet filter

8 Maintenance

8.1 Test digital I/O

Menu: **Maintenance/Tests**

This menu serves to test the digital interfaces.

- ▶ Click the desired interface (mark).
- ▶ Perform with „Test“.
- ▶ A menu to set the parameters appears.
- ▶ (Field “Save” has no significance).

Test digital inputs

Index	Module	Name	Inverted
1	NULL	NN	<input type="checkbox"/>
2	NULL	NN	<input type="checkbox"/>
3	NULL	NN	<input type="checkbox"/>
4	NULL	NN	<input type="checkbox"/>

Figure 105: Menu Digital inputs

Test digital outputs

Index	Module	Source	Inverted
1	NULL	NULL	<input type="checkbox"/>
2	NULL	NULL	<input type="checkbox"/>
3	NULL	NULL	<input type="checkbox"/>
4	NULL	NULL	<input type="checkbox"/>

Figure 106: Menu Digital outputs

8.2 Setting operating states

Menu: **Maintenance/Operating states**

This menu serves to switch the operating states of the MARSIC300 on.



- ① Switch button: LED on: Status signal "Maintenance" is switched on.
- ② System Stop.
- ③ Switch to measuring operation.
- ④ Switch to measuring operation (after changes in menu: Parameterization/Measuring components/...).

Figure 107: Menu Operating states

8.3 System maintenance (Stand-by, Leakage test, etc.)

Menu: Maintenance/Maintenance System

This menu serves to start various maintenance procedures.

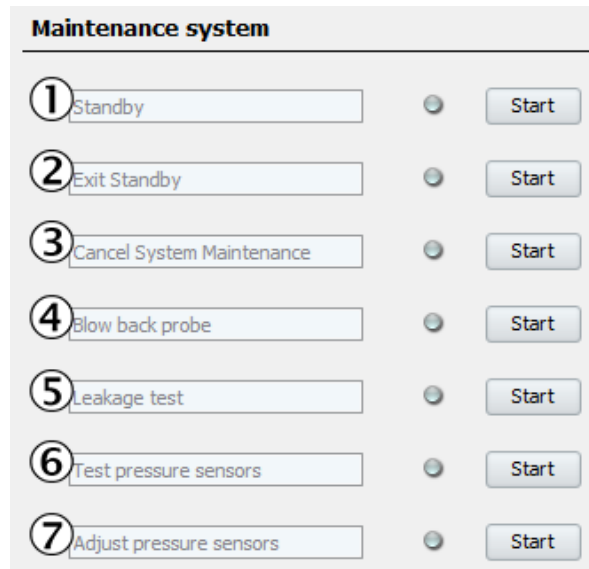

Figure 108: Menu System maintenance

- ① **Standby**
Switches the system to Standby to put it out of operation for some time.
- ② **Exit Standby**
Switches the system back to regular measuring operation. (After it was switched to Standby using item "1" of this menu).
- ③ **Cancel system maintenance**
Abort a program started in this menu.

- ④ **Blow back probe**
Triggers a backflush of the probe tube (as well as the inlet filter when fitted on the probe tube) with instrument air.
 - Press "Start" to start the backflush.
 - Operating state: "Maintenance".
 - The measuring screen appears with a downwards counter to the end of the adjustment.
 - The system switches back to operating state "Measure" when the adjustment has completed (when "Maintenance" was set manually beforehand: Back in "Maintenance").
- ⑤ **Leakage test**
Start a leak tightness check.
- ⑥ **Test pressure sensors**
Checks the pressure sensors.
Perform this check when you have the impression that a pressure sensor is defective.
 - "Test OK" means: The pressure sensors are OK.
 - "Test failed" means: One of the pressure sensors is defective. Replace pressure control module.
- ⑦ **Adjust pressure sensors**
After replacing the pressure control module: Perform this menu item.



NOTE

Further information, see "MARSIC300 Operating Instructions".

8.4 Restart

Menu: Maintenance/Restart System

This menu serves to restart the system.

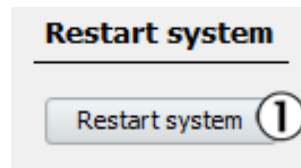

① Start "Restart system"

Figure 109: Menu Restart system

8.5 Service log

Menu: Maintenance/Service Log

Completed maintenance work can be entered in this Table as clear text.

Index	Date ①	Service ②	Entry
1	29.12.2014	Mr. Smith	Beam Source changed ③
2	dd.mm...	NULL	NULL
3	dd.mm...	NULL	NULL

Figure 110: Menu Service Log

- ① Date [dd.mm.yyyy]
- ② Service engineer name
- ③ Completed maintenance work in clear text

8.6 Acknowledging messages

Menu: **Maintenance/Confirm active messages**

This menu resets all pending active messages.

LED "MAINTENANCE REQUEST" goes off.

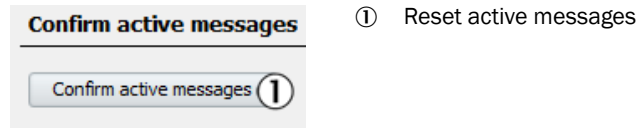

Figure 111: Menu Confirm active messages

8.7 Loading/saving the parameters

Parameters can be loaded/saved as parameter sets in different versions:

Table 11: Parameter sets

Factory setting	/opt/analyser/backup/
Parameter 1	/pccard/backup1/
Parameter 2	/pccard/backup2/
Parameter 3	/pccard/backup3/

Load/Save parameter

After load parameters the System restarts.

Factory settings

Date

with SW-version

SD card

Time of store

with SW-version

SD card

Time of store

with SW-version

SD card

Time of store

with SW-version

Figure 112: Menu Tree Loading/saving parameters in SOPAS ET

8.8 Loading/saving the parameters after replacing the analyzer

Load the configuration of the old analyzer module to the new analyzer module after replacement. This can be done easily using SOPAS ET.

1. Insert the SD card of the previous electronics in the new electronics.
2. Switch the device on.
3. Login as "Authorized User".
4. Select menu Maintenance/Replace analyzer.
5. Click <Load customer-specific parameters> (This loads just the customer-specific data from the SD card).
6. Wait until the device restarts.

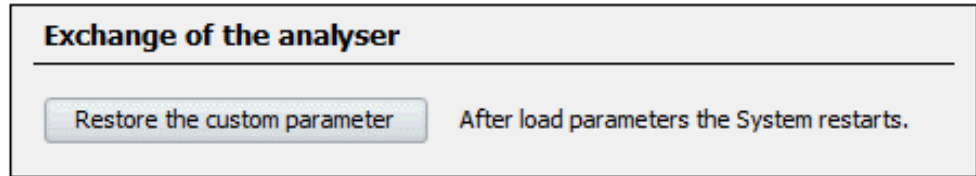

Figure 113: Menu Tree Analyzer replacement in SOPAS ET

8.9 Loading/saving the parameters after replacing the electronics

Load the configuration of the old electronics unit to the new electronics unit after replacement. This can be done easily using SOPAS ET.

1. Insert the SD card of the previous electronics in the new electronics.
2. Switch the device on.
3. Login as "Authorized user".
4. Select menu Maintenance/Electronics replacement.
5. Click <Load all parameters> (this load all data from the SD card).
6. Wait until the device restarts.

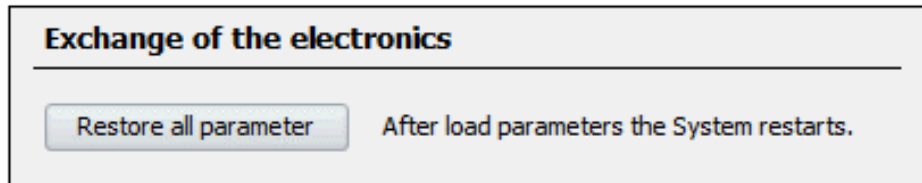

Figure 114: Menu Tree Electronics replacement in SOPAS ET

9 Maintenance

9.1 Leak tightness check during initial startup

1. Perform the leak tightness check when the device is running.



WARNING

Risk of burns on hot cell

The cell is very hot (approx. 200 °C).

For the leak tightness check, the line on the sample gas outlet must be unscrewed when the cell is hot.

- ▶ Use heat-resistant gloves.
- ▶ Use heat-resistant tool.

1. Start program **Maintenance/Maintenance Sys./Leakage Test**.
2. Wait until message "Close outlet - discon. purge" appears.

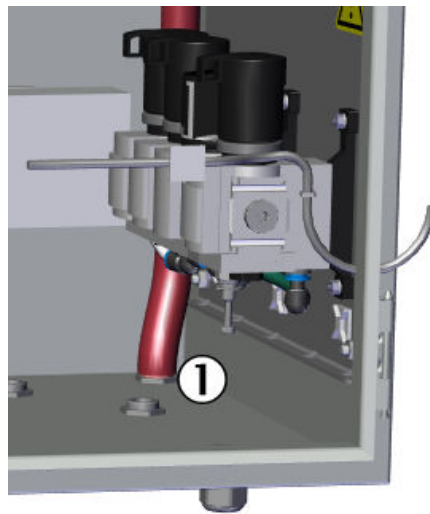

Figure 115: Sample gas outlet (inside view)

- ① Sample gas outlet

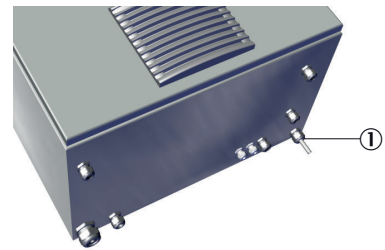

Figure 116: Sample gas outlet (outside view)

- ① Sample gas outlet at bottom rear of the housing

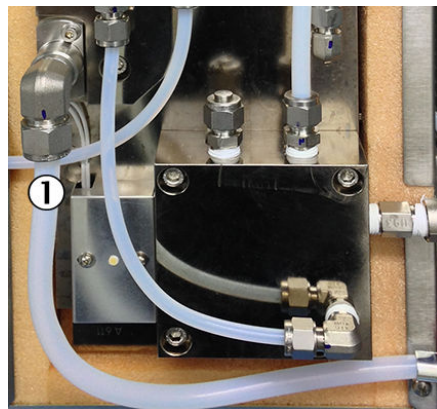

Figure 117: Sample gas outlet - cell

- ① Sample gas outlet on cell

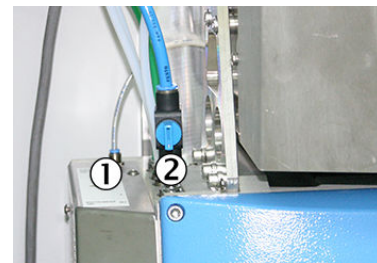

Figure 118: Analyzer module - Connections

- ① Rear (thin) flush air line
- ② Instrument air valve (shown "open")

3. On Analyzer module: Disconnect rear purge air line (press ring to do so).

4. Close off sample gas outlet gas-tight:
 - Either at the end of the sample gas outlet line (the line does not end at the enclosure duct but runs through to the cell in the enclosure).
The leak test tool kit has a suitable plug to close off the sample gas outlet line.
 - Or on the cell at the sample gas outlet (10 mm clamping ring sealing plug, the plug is also in the leak test tool kit).
To do this, open the cell: Loosen 4 side screws and remove cover.
5. The pressure in the system slowly rises.
Message “close air valve” appears when the pressure is ≥ 1200 hPa (after about 30 seconds) (the current pressure is shown in the “Measured value display”).
6. Close instrument air valve.
 - The pressure no longer rises and measurement starts automatically after about 20 seconds: Measurement duration approx. 5 minutes.
 - Pressure loss during this time must not exceed 20 hPa. A message is shown:
 - “Test OK - open air valve”: Test successful.
 - “Test failed - open air valve”: Test unsuccessful: Analyzer switches to “Maintenance request” state.
7. Open instrument air valve again.
8. Wait until message “Reopen outlet - connect purge” appears.
9. Reconnect rear purge air line.
10. Restore sample gas outlet to its original state.

9.2 Leak tightness check with pressure test tool

This Section describes the leak tightness check with the SICK “Leak test tool kit”.

Table 12: Screw fittings

Cap	Size
Probe tube	
Sample gas inlets	2 x clamping ring screw fittings 8/10
Span gas inlet	1 x clamping ring screw fitting 4/6
Ejector block	3 x clamping ring screw fitting 4/6

Procedure

1. Switch analyzer to “Standby”: [see "System maintenance \(Stand-by, Leakage test, etc.\)", page 70.](#)
2. Flush system for 10 minutes in this state.
Start removing the probe during the flush duration: See “SFU Gas Sampling System Operating Instructions”.
3. Close off external instrument air supply.
4. Close probe tube at gas inlet.
5. Open cell enclosure.
6. Unscrew exhaust gas line 1 from sample gas outlet of ejector.

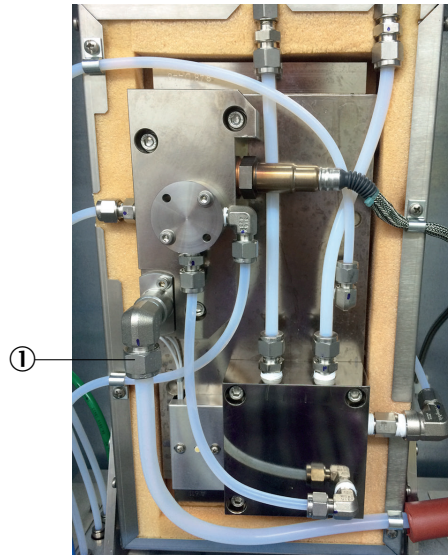

Figure 119: Sample gas outlet (inside view)

① Ejector sample gas outlet

7. Connect PTFE connecting hose of the test tool to sample gas output of ejector.
8. Unscrew all further lines marked in the Figure and close connections on the cell gas-tight.
9. Perform a leak tightness check: See “Pressure Test Tool Operating Instructions”.
 - Test duration: 5 minutes
 - The "leak" pressure rise must be < 10 mbar (< 0.14 psi). If the pressure rise is higher, search for and clear the leak in the gas path.
10. Connect all lines again after successful leak tightness check.
11. Refit the probe.
12. Switch standby off again.

10 Technical data



NOTE

The Technical data depend to some extent on the individual equipment of your analyzer.

- ▶ See the system documentation provided for the configuration of your analyzer.

10.1 Dimensional drawings

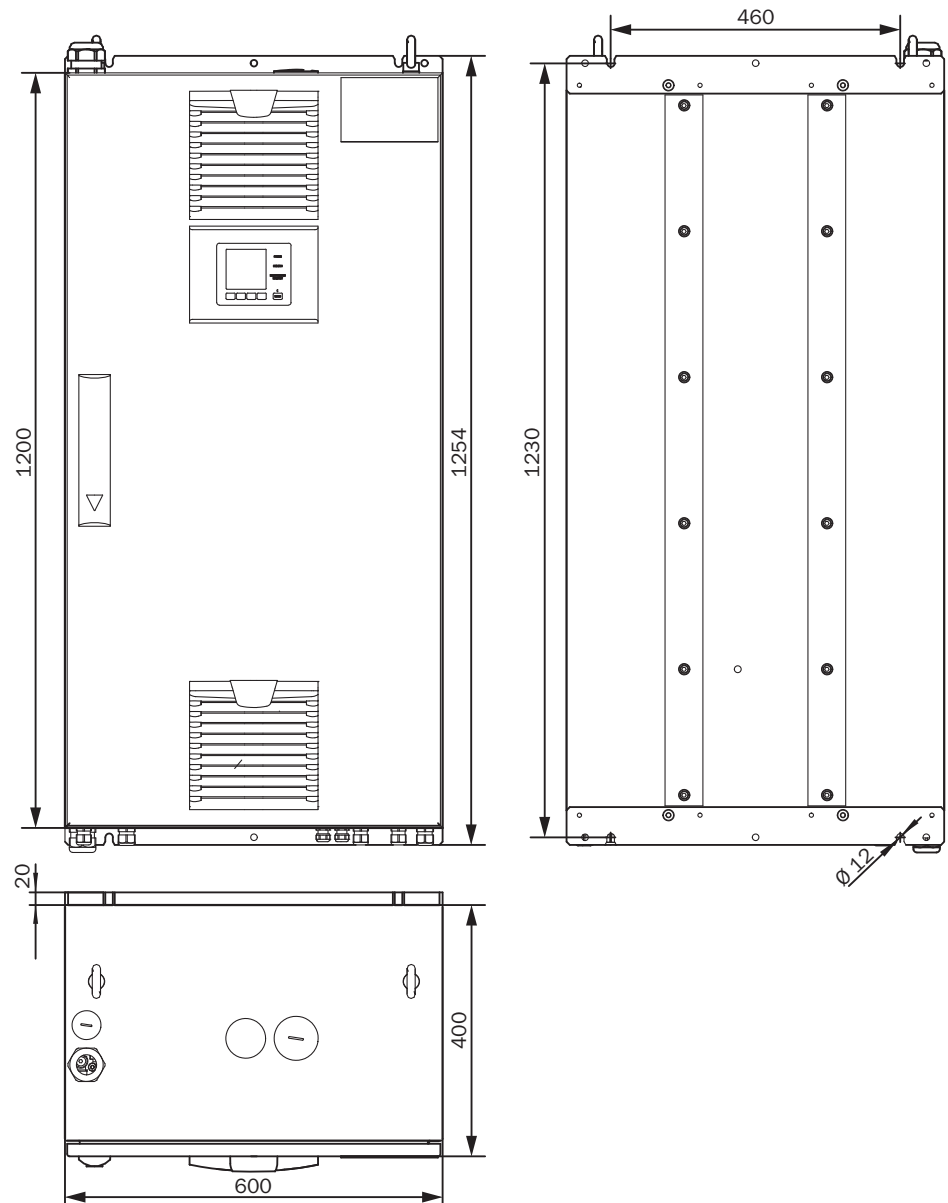

Figure 120: Analyzer cabinet - dimensional drawing



NOTICE

Observe clearances:

- Top: 30 cm
- Bottom: 20 cm

10.2 Design

Table 13: Design

Design	
Design	1 x wall housing
Material, general	Steel plate, aluminium cast
Dimensions	see "Dimensional drawings", page 78
Installation	Wall fitting
Weight	Approx. 120 kg
Materials with media contact	<ul style="list-style-type: none"> Stainless steel 1.4571 PTFE Aluminium (coated)
Degree of protection	IP 54

10.3 Measuring parameters

Table 14: Sample gases

Variants	Components
DeSO _x	SO ₂ , CO ₂ , H ₂ O, optional O ₂
DeNO _x	NO, NO ₂ , H ₂ O, optional O ₂
Emission	SO ₂ , CO ₂ , NO, NO ₂ , CO, CH ₄ , NH ₃ , H ₂ O, optional O ₂

Table 15: Measured variables

Number of measured variables	
Number of measured variables	Max. 9

Table 16: Measuring method

Measuring method	
Measuring method	Hot extractive

Table 17: Spectral range

Spectral range	
Spectral range	2000 ... 11000 nm

Table 18: Sample volume

Sample volume	
Sample volume	200 ... 300 l/h

Table 19: Sample gas - measuring range

Component	Measuring range
SO ₂	0 ... 30 ppm; 0 ... 2000 ppm
CO ₂	0 ... 25% by vol.
O ₂	0 ... 21% by vol.
NO	0 ... 300 ppm; 0 ... 2000 ppm
NO ₂	0 ... 200 ppm; 0 ... 500 ppm
CO	0 ... 200 ppm; 0 ... 2000 ppm
NH ₃	0 ... 50 ppm; 0 ... 500 ppm
CH ₄	0 ... 500 ppm; 0 ... 10000 ppm

Component	Measuring range
H ₂ O	0 ... 40% by vol.

Table 20: Measuring point switchover

Measuring point switchover	
Measuring point switchover	Max. 2 measuring points (optional 8 measuring points)

Table 21: Measured value characteristics

Measured value characteristics	
Measuring principle	Photometric
Measuring precision	< 2% of the respective full scale value
Detection limit	< 2% of the respective full scale value
Sensitivity drift	< 2% of the respective full scale value per week
Zero drift	< 2% of the respective full scale value per week
Span drift	< 2% of the respective full scale value per week
Setting time t ₉₀	< 140 s, total measuring path as from probe extraction

10.4 Ambient conditions

Table 22: Ambient conditions - in operation

Ambient conditions in operation	
Installation location	Below deck
Ambient temperature	+0 ... +45 °C
Relative humidity	< 90% (without condensate)
Air pressure	900 ... 1100 hPa
Degree of protection	IP 54

Table 23: Ambient conditions - in storage

Ambient conditions in storage	
Ambient temperature	-20 ... +70 °C
Relative humidity	< 90% (without condensate)

10.5 Sample gas conditions

Table 24: Sample gas characteristics

Sample gas at the measuring point	Characteristic
Process temperature	10 ... 550 °C
Sample gas temperature subassembly: <ul style="list-style-type: none"> • Sample gas probe • Sample gas line • Cell 	Temperature: <ul style="list-style-type: none"> • Approx. 200 °C • Approx. 200 °C • Approx. 200 °C
Process pressure	-20 ... +200 hPa relative
Dust load	< 200 mg/m ³

10.6 Heated sample gas lines

Table 25: Sample gas line - characteristics

Sample gas line	
Length	Max. 35 m
Ambient temperature	-20 ... 80 °C
Working temperature	Max. 200 °C
Temperature control	1 x Pt100 1 x additional Pt100 as reserve
Power supply	115 V or 230 V
Power consumption	90 VA/m
Degree of protection	IP 54

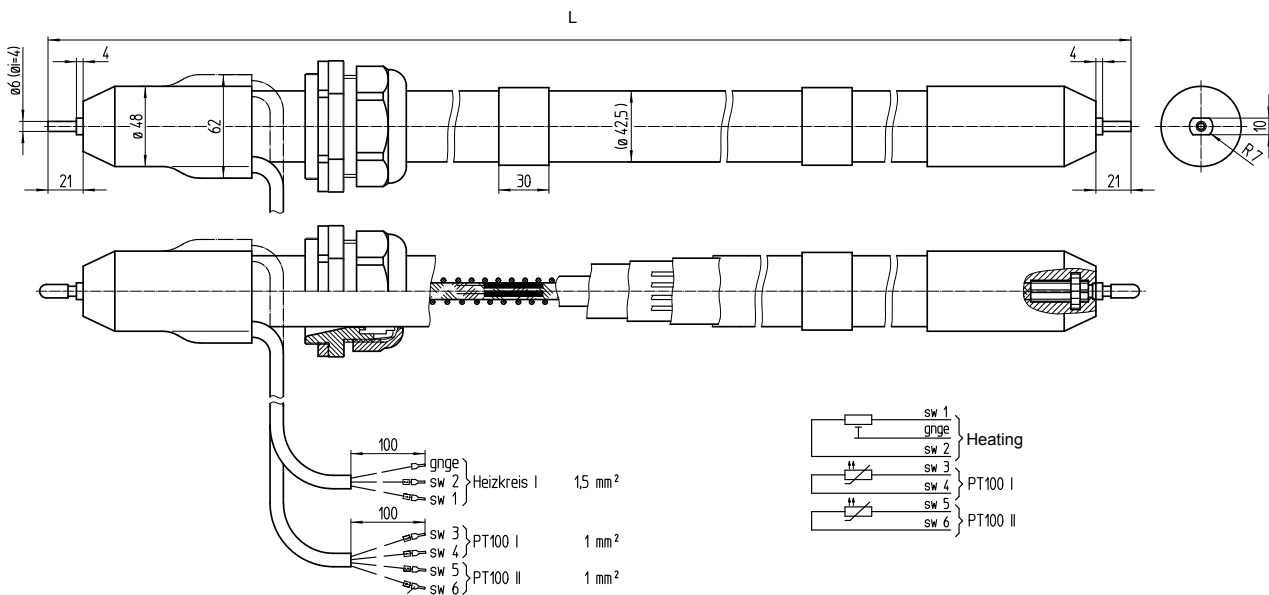

Figure 121: Heated sample gas line

10.7 Tube bundle cable

No.	Designation	Function	Dimension
①	Power supplies	Lines 1 and 2: Gas sampling filter Lines 3 and 4: Probe tube (optional)	4 x 1.5 mm ²
②	Signal lines (Pt100)	Lines 1 and 2: Gas sampling filter Lines 3 and 4: Probe tube (optional)	4 x 1.0 mm ²
③	Grounding conductor (gngce)	Ground	1 x 4.0 mm ²
④	PTFE hose (white)	Zero gas	DN 4/6
⑤	PA hose (black)	Control air main valve	DN 6/8
⑥	PA hose (blue)	Backflush air	DN 6/8

10.8 Interfaces and protocols

Table 26: Interfaces and protocols

Operation and interfaces	
Operation	Via LC-Display or SOPAS ET software, several operating levels, password-protected
Display and input	Black-and-white foiled screen with function buttons Status LEDs <ul style="list-style-type: none"> • "Power" • "Malfunction" • "Maintenance request"
Analog outputs	Optional
Digital inputs/outputs	Optional
Data interface	1 x Ethernet (Modbus TCP/IP)
Profibus	Optional
Profinet	Optional
Remote maintenance	SICK MPR (optional)
PC operation	SOPAS ET via Ethernet

10.9 Power supply

Table 27: Power supply



Power supply	
Supply voltage (preset)	<p>IT network (without neutral conductor, not grounded)</p> <ul style="list-style-type: none"> • 3~230 V, PE • 3~208 V, PE <p>3~ 230 V L/L/PE </p> <p><i>Figure 122: IT network switching</i></p> <p>TN(S) network (with neutral conductor, grounded)</p> <ul style="list-style-type: none"> • 3~230 V, N, PE • 3~115 V, N, PE <p>3~ 230 V L/N/PE </p> <p><i>Figure 123: TN(S) network switching</i></p> <p>Further variants optional (e.g.: 1~230 V, 2~208 V)</p> <p>► Refer to the system documentation provided for the default value.</p>
Frequency	50/60 Hz
Power consumption	<p>Power consumption</p> <ul style="list-style-type: none"> • Analyzer • Heated sample gas line • Gas sampling system • Heated probe tube <ul style="list-style-type: none"> • Approx. 1000 VA • Approx. 95 VA/m • Approx. 450 VA • Approx. 450 VA

Table 28: Line cross-sections

Line cross-sections (relative to leads with ferrules)	
<ul style="list-style-type: none"> CAN RS485 	Line cross-section: 0.14 ... 1.5 mm ² AWG28 ... AWG16
<ul style="list-style-type: none"> Pt100 inputs 24 V DC valve outputs Digital inputs Relay outputs (potential-free) 	Line cross-section: 0.25 ... 2.5 mm ² AWG30 ... AWG12
<ul style="list-style-type: none"> External heating circuits 	Line cross-section: 0.25 ... 4.0 mm ² AWG30 ... AWG10
<ul style="list-style-type: none"> Power supply 	Line cross-section: 0.5 ... 6.0 mm ² AWG20 ... AWG7

Table 29: Optional interfaces

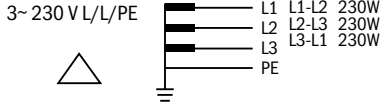
Interfaces (optional)	
Digital outputs	4 outputs, 24 V, 0.5 A
Digital inputs	Electrically isolated, 24 V, 0.3 A
Analog outputs	Optional

10.10 Connections in analyzer

Power supply - connection / fuses

The power supply is located on the left on the analyzer.

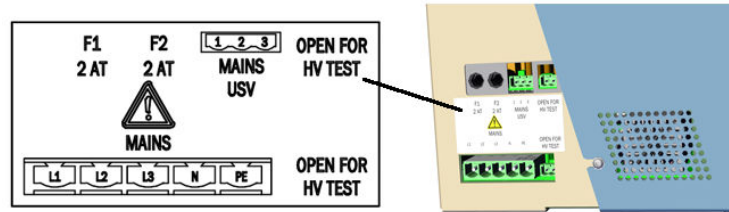

Figure 124: Power supply connections

Table 30: Power supply - connections

Name	Supply
MAINS USV (3-pole)	Power supply for electronics unit (internal)
MAINS (5-pole)	External power supply
F1	Internal
F2	Internal

Electronics fuses

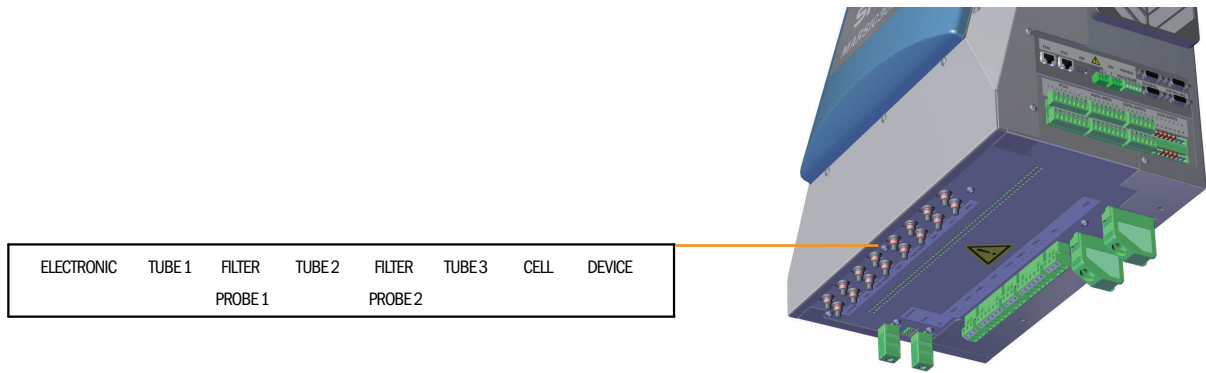

Figure 125: Electronics connections

Table 31: Electronics connections

Name	Fuse for
ELECTRONIC	Electronics
TUBE 1	Sample gas line 1
FILTER/PROBE 1	Filter heater 1
TUBE 2	Sample gas line 2
FILTER/PROBE 2	Filter heater 2
TUBE 3	Sample gas line 3
CELL	Sample gas cell
DEVICE	Device

Connections for heated components

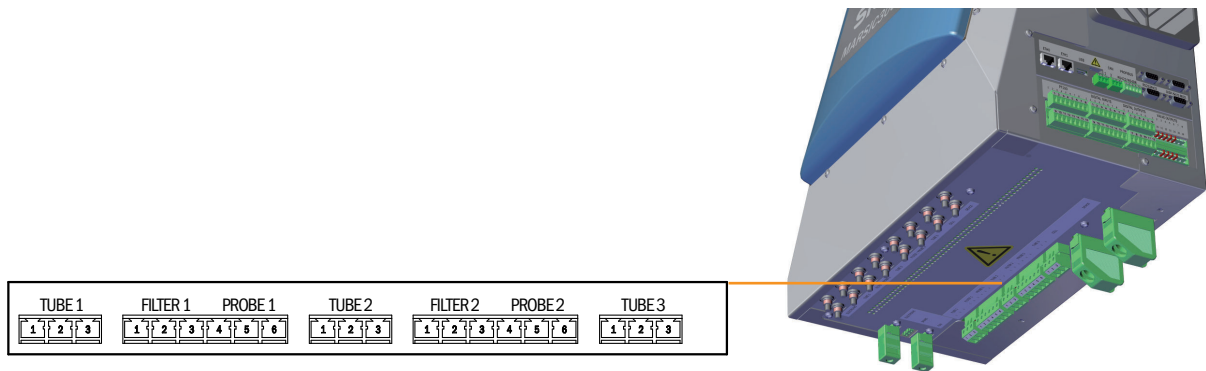

Figure 126: Connections for heated components

Table 32: Connections - pin assignment

Plug	Subassembly	Pin	Assignment	Tube bundle cable line number ¹	
TUBE 1	Sample gas line 1	1	L (L)		
		2	N (L)		
		3	PE		
FILTER1	Gas sampling system filter 1 (Lines from tube bundle cable)	1	L (L)	4x1.5 mm ²	1
		2	N (L)		2
		3	PE	1x4 mm ²	GNYE

Plug	Subassembly	Pin	Assignment	Tube bundle cable line number ¹
PROBE1	Gas sampling system probe tube 1 (Lines from tube bundle cable)	4	L (L)	4x1.5 mm ² 3
		5	N (L)	4
		6	PE (not connected)	
TUBE2	Sample gas line 2	1 ... 3	As for TUBE1	
FILTER2	Gas sampling system filter 2	1 ... 3	As for FILTER1	
PROBE2	Gas sampling system probe tube 2	4 ... 6	As for PROBE1	
TUBE3	Sample gas line 3			

¹ The connections must match the connections on the gas sampling system

Connections for interfaces and SD card

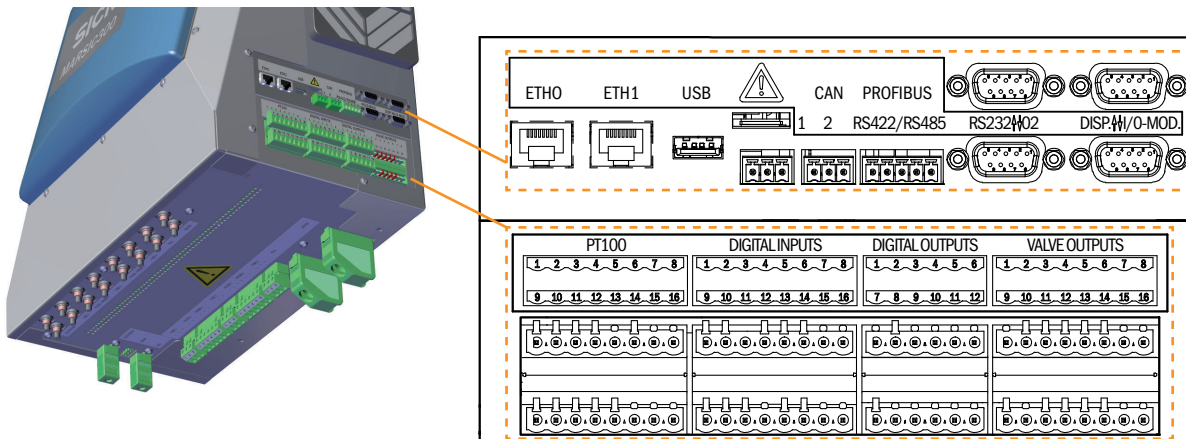

Figure 127: Connections overview

Table 33: Data interfaces - overview

Plug	Connection for
ETH0	Ethernet (e.g. SOPAS ET), MPR (remote maintenance), communication via Modbus TCP
ETH1	Internal
USB	Internal
SD card	SD card (on the right, next to USB)
CAN1	Internal
CAN2	Internal
RS422, RS485	Internal
RS232 (top plug)	Internal
O2 (bottom plug)	O ₂ sensor
DISP (top plug)	Display
I/O-MOD (bottom plug)	Internal

Pt100 and signal connections

Table 34: Overview - pin assignment and signals

Plug	Subassembly	Pin	Assignment	Tube bundle cable line number ¹	
Pt100	Sample gas line 1	1	Pt100 +		
		2	Pt100 -		
	Gas sampling system filter 1	3	Pt100 +	4x1.0 mm ²	1
		4	Pt100 -		2
	Gas sampling system probe tube 1	5	Pt100 +		3
		6	Pt100 -		4
	Not connected	7			
		8			
	Sample gas line 2	9, 10	As above		
	Gas sampling system filter 2	11, 12	As above	4x1.0 mm ²	
	Gas sampling system probe tube 2	13, 14	As above		
	Sample gas line 3	15	Pt100 +		
		16	Pt100 -		
	DIGITAL INPUTS	Digital input 1	1	+ 24 V	
2			+ Signal		
3			- Signal		
4			GND		
Digital input 2		5 ... 8	As above		
Digital input 3		9 ... 12	As above		
Digital input 4		13 ... 16	As above		
DIGITAL OUTPUTS	Digital output 1	1	NC		
		2	COM		
		3	NO		
	Digital output 2	4 ... 6	As above		
	Digital output 3	7 ... 9	As above		
	Digital output 4	10 ... 12	As above		
VALVE OUTPUTS	Valves		Internal		

¹ The connections must match the connections on the gas sampling probe

10.11 Circuit breakers

The circuit breakers are located at the bottom of the electronics unit.

The circuit breakers are labeled.

When a circuit breaker has triggered:

- ▶ Press the circuit breaker pin back in again.
If this does not work:
 - ▷ Wait for a few minutes (cooling down phase) and then press the pin back in again.
If this does not work: Check the subassembly and replace when necessary.

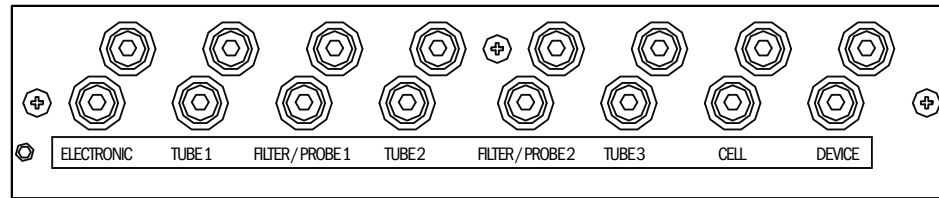

Figure 128: Circuit breakers

10.12 Supply gases



NOTICE

Risk of contamination of analyzer

- ▶ Observe the specified quality of the instrument air.
- ▶ If required, provide for instrument air conditioning.

Table 35: Supply gases

Gas	Quality	Inlet pressure	Flow rate
Instrument air (zero gas quality)	Particle size max. 1 µm Oil content max. 0.1 mg/m ³ Pressure dew point max. -40 °C Purity class 2 (ISO 8573)	600 ... 700 kPa (6.0 ... 7.0 bar)	Approx. 350 l/h
Instrument air solely as induction air for ejector	Particle size max. 5 µm Oil content max. 1 mg/m ³ Pressure dew point max. +3 °C Purity class 3 (ISO 8573)	500 ... 700 kPa (5.0 ... 7.0 bar)	Approx. 1300 l/h
External span gas	Precision: ± 2 % Concentration: 80% ... 100% of measuring range The span gas must comply with the specifications of the standards to be applied (e.g., MARPOL Annex VI)	Max. 400 kPa (4.0 bar)	Approx. 350 l/h

10.13 Tube connections

Table 36: Tube connections

Connection	Dimension
Sample gas inlet	Clamping ring screw connection 6 mm
Ejector induction air	DN 6/8
Span gas inlet	Clamping ring screw connection 6 mm
Gas outlet	DN 8/10

10.14 Torques

Tighten all screw connections, for which no tightening torque or no pretension force is specified in drawings or Assembly Instructions, according to VDI 2230.

Exceptions to this rule are all connections with screws that are not screw connections in the real sense. This includes hose clips, cable glands, screw fittings, gas connections, screws for circuit boards etc. Tighten these screw fittings as evenly as possible with a much lower torque (hose clips 1 Nm, other screw fittings according to manufacturer specifications).

Select the next lowest torque valid for the screw for mixed materials and special screws such as relieved screws.

The friction coefficient serving as basis is (screw fitting without lubrication) $\mu_k = \mu_G = 0.14$. The calculated values are valid for room temperature ($T = 20^\circ\text{C}$).

Table 37: Torques

Size M	Pitch P	Tightening torque Ma (Nm)					
		3.6	4.6	5.6	8.8, A2 u. A4-80	10.9	12.9
1.6	0.4	0.05		0.05	0.17		0.28
2	0.45	0.1		0.11	0.35		0.6
2.5	0.45	0.21		0.23	0.73		1.23
3	0.5		0.54	1	1.3	1.7	2
3.5	0.6		0.85	1.3	1.9	2.6	3.2
4	0.7		1.02	2	2.5	4.4	5.1
5	0.8		2	2.7	5	8.7	10
6	1		3.5	4.6	10	15	18
8	1.25		8.4	11	25	36	43
10	1.5		17	22	49	72	84
12	1.75		29	39	85	125	145
14	2		46	62	135	200	235
16	2		71	95	210	310	365
18	2.5		97	130	300	430	500
20	2.5		138	184	425	610	710
22	2.5		186	250	580	830	970
24	3		235	315	730	1050	1220
27	3		350	470	1100	1550	1800
30	3.5		475	635	1450	2100	2450
33	3.5		645	865	2000	2800	3400
36	4		1080	1440	2600	3700	4300
39	4		1330	1780	3400	4800	5600

11 Annex

11.1 Gas flow plan

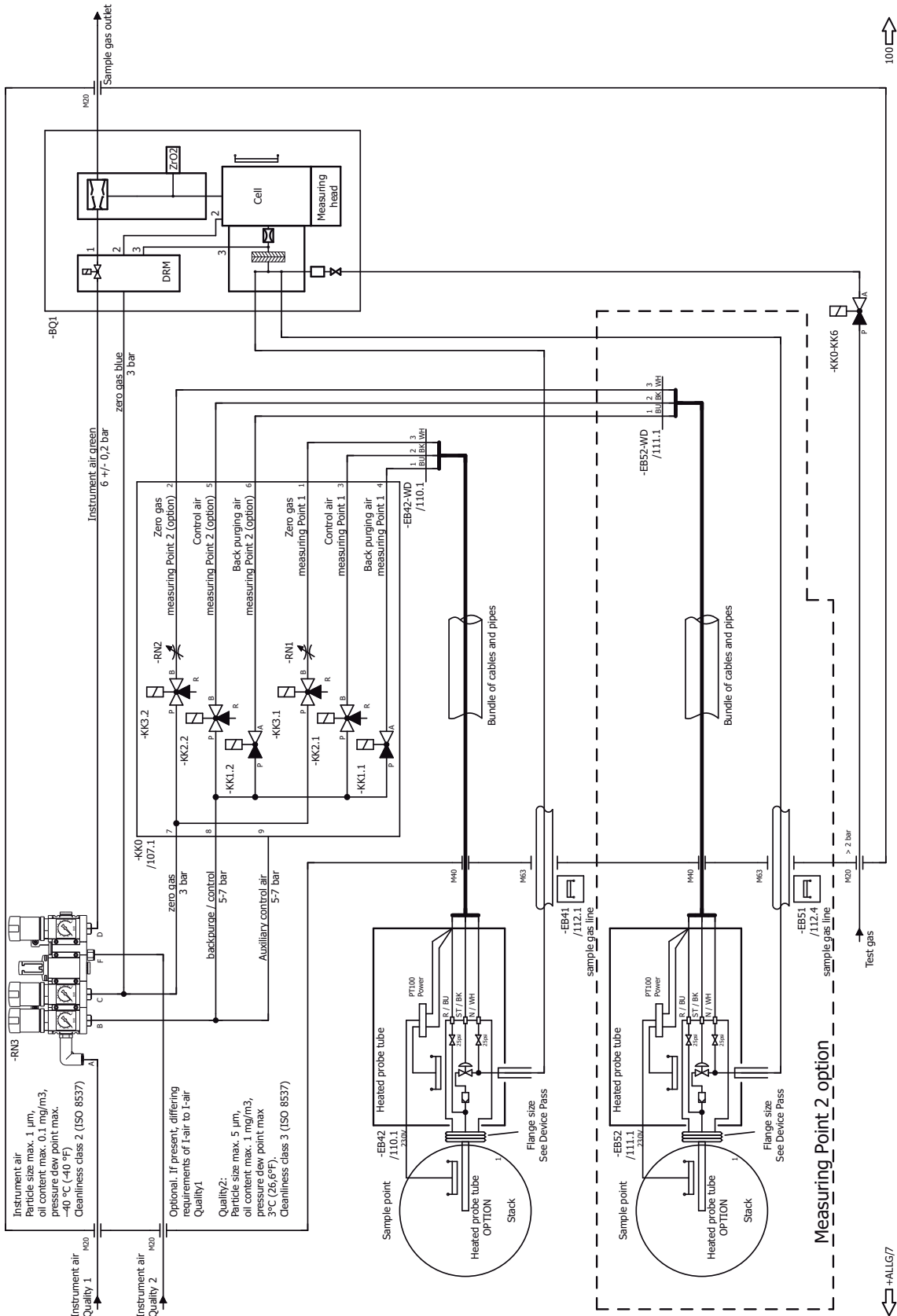

Figure 129: Gas flow plan

11.2 Modbus register

11.2.1 Device status (Discrete Inputs [1xxxx], Function Code 02)

Table 38: Discrete Inputs

Discrete Input No.	Date/Time
1000	Device group status malfunction
1001	Device group status maintenance request
1002	Device group status maintenance
1003	Device group status outside specification
1004	Measured data are live/current (0 = held, 1 = alive)
1008	Gas feed via measuring point_01
1009	Gas feed via measuring point_02
1010	Gas feed via measuring point_03
1011	Gas feed via measuring point_04
1012	Gas feed via measuring point_05
1013	Gas feed via measuring point_06
1014	Gas feed via measuring point_07
1015	Gas feed via measuring point_08
1016	Gas feed via measuring point_09
1017	Gas feed via measuring point_10
1018	Gas feed via measuring point_11
1019	Gas feed via measuring point_12
1024	Zeroize (Val./Adj.)
1025	Span check (Val./Adj.)
1026	Zeroize/span check (Val./Adj.), total signal

11.2.2 Measured variables (Input Register [3xxxx], Function Code 04)

If not measuring: Register = "0"

Table 39: Input Register - measured variables

Input Register No	Measured variable
1000 [Float]	SO2
1002 [Float]	CO2
1004 [Float]	Ratio SO2/CO2
1006 [Float]	H2O
1008 [Float]	NO
1010 [Float]	NO2
1012 [Float]	NOx
1014 [Float]	NH3
1016 [Float]	CO
1018 [Float]	CH4
1020 [Float]	O2
1022 [Float]	VOC
1050 [DInt]	Active Sampling Point = 0 means maintenance or value not active. ≠ 0 measured value comes from measuring point x and is active.
1052 [DInt]	Shown Sampling Point = 0 means maintenance. ≠ 0 measured value comes from measuring point x.

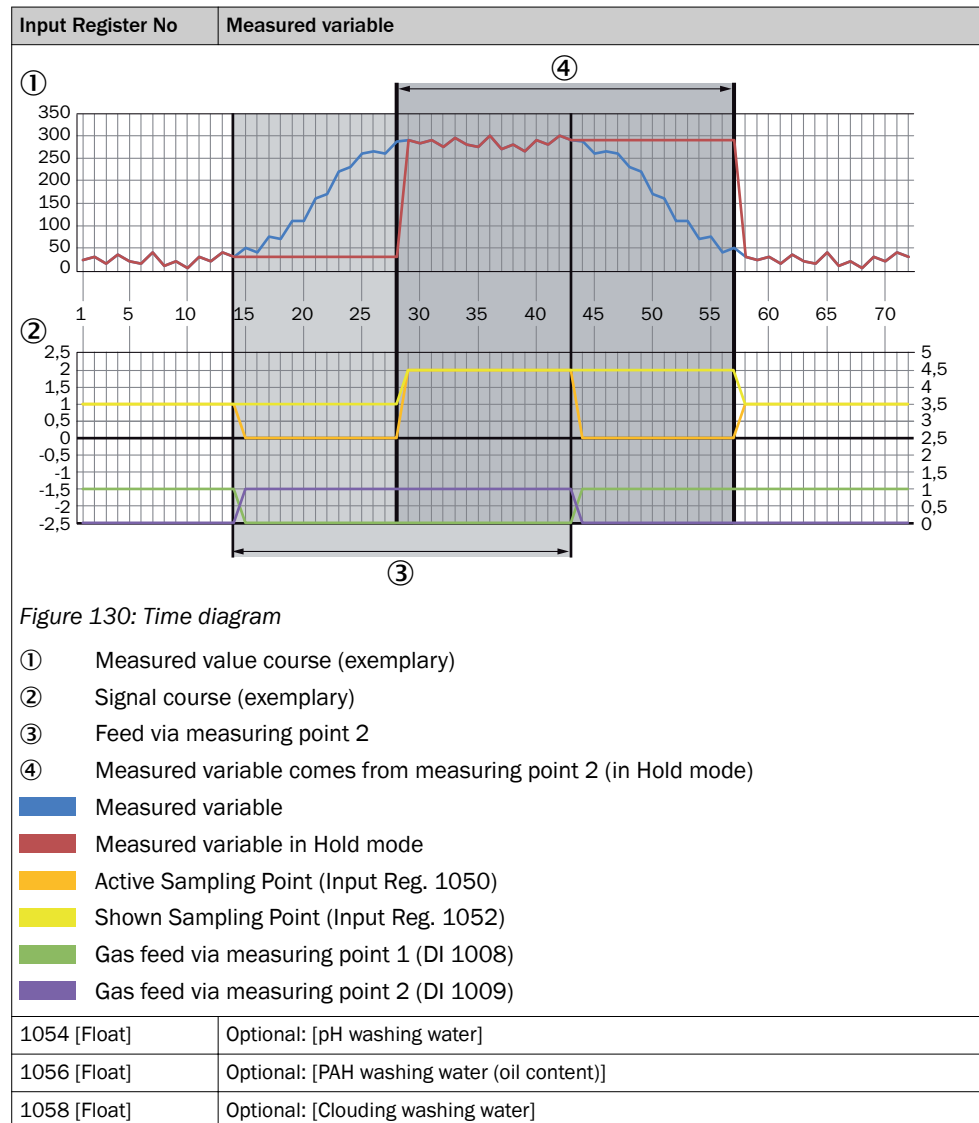

11.2.3 Device-internal monitoring values (Input Register [3xxx], Function Code 04)

Table 40: Input Register - monitoring value

Input Register No	Internal variable
2000 [Float]	Sample gas flow
2002 [Float]	T_Cell (heating measuring cell)
2004 [Float]	T_Optics (heating optics)
2006 [Float]	T_Ext1 (external heating 1)
2008 [Float]	T_Ext2 (external heating 2)
...	...
2018 [Float]	T_Ext7 (external heating 7)
2020 [Float]	T (ambient)
2022 [Float]	T (LPMS01)
2024 [Float]	T (LPMS02)
2026 [Float]	T (LPMS03)
2028 [Float]	p(0)
2030 [Float]	p(2)

Input Register No	Internal variable
2032 [Float]	p (ambient)
2034 [Float]	Δp
3000 [Float]	SO2 low [0..250]
3002 [Float]	SO2 high [0..2000]

11.2.4 Triggering the MARSIC 300 (Coils [0xxxx], Function Code 15, write multiple Coils)

Table 41: Activation - coils

Coil No.	Action
2000	Select measuring point_01
2001	Select measuring point_02
2002	Select measuring point_03
2003	Select measuring point_04
2004	Select measuring point_05
2005	Select measuring point_06
2006	Select measuring point_07
2007	Select measuring point_08
2008	Select measuring point_09
2009	Select measuring point_10
2010	Select measuring point_11
2011	Select measuring point_12
2012	Trigger Standby
2013	Trigger BlowBack
2014	Trigger Zeroize
2015	Trigger Span Set (internal)
2016	Trigger zero validation
2017	Trigger span validation (internal)
2018	Trigger adjustment O2

Remarks:

- The external selection is activated as soon as release signal '1' is set. If this is not done, the measuring points are automatically triggered sequentially.
- Standby: 1 = Standby, 0 = Measuring operation.
- Zero and span set: "1" The adjustment/validation process starts for 5 seconds; the trigger signal must then be disabled.

11.2.5 VDI 4301 conform range (Holding Register [4xxxx], Function Code 03)

Table 42: VDI - Holding Register

Holding Register No.	Measured variable
4000 [32 Bit Float, scaled according to VDI]	SO2
4002 [32 Bit DInt]	Device status
4004 [32 Bit Float, scaled according to VDI]	CO2
4006 [32 Bit DInt]	Device status
4008 [32 Bit Float, scaled according to VDI]	Ratio SO2/CO2
4010 [32 Bit DInt]	Device status
4012 [32 Bit Float, scaled according to VDI]	H2O
4014 [32 Bit DInt]	Device status
4016 [32 Bit Float, scaled according to VDI]	NO

Holding Register No.	Measured variable
4018 [32 Bit DInt]	Device status
4020 [32 Bit Float, scaled according to VDI]	NO2
4022 [32 Bit DInt]	Device status
4024 [32 Bit Float, scaled according to VDI]	NOx
4026 [32 Bit DInt]	Device status
4028 [32 Bit Float, scaled according to VDI]	NH3
4030 [32 Bit DInt]	Device status
4032 [32 Bit Float, scaled according to VDI]	CO
4034 [32 Bit DInt]	Device status
4036 [32 Bit Float, scaled according to VDI]	CH4
4038 [32 Bit DInt]	Device status
4040 [32 Bit Float, scaled according to VDI]	O2
4042 [32 Bit DInt]	Device status
4044 [32 Bit Float, scaled according to VDI]	VOC
4046 [32 Bit DInt]	Device status
4064 [32 Bit Float, scaled according to VDI]	Number of active measuring point
4066 [32 Bit DInt]	Device status
4068 [32 Bit Float, scaled according to VDI]	Number of triggered measuring point
4070 [32 Bit DInt]	Device status
4072 [32 Bit Float, scaled according to VDI]	pH washing water
4074 [32 Bit DInt]	Device status
4076 [32 Bit Float, scaled according to VDI]	PAH washing water (oil content)
4078 [32 Bit DInt]	Device status
4080 [32 Bit Float, scaled according to VDI]	Clouding washing water
4082 [32 Bit DInt]	Device status

Remark: The device status is added for each measured value for conformity reasons. Device status format. The individual status has the same significance as the device status of Discrete Inputs 1000 et seq.

Bit No.	
0	Malfunction
1	Maintenance
2	Maintenance request
3	Outside the specification
4	Test operation according to VDI

11.3 Error messages and possible causes

Current pending messages are shown on the device display.

A combined list of messages is included in SOPAS ET (see "MARSIC300 Technical Data").



NOTE

The following Table only includes those messages with classification "X" that are important for information.

Messages not included in the following Table have no further significance for operation.



NOTE

Display of current device state data: Menu Diagnosis/System param.

C = Classification

F = Failure

M = Maintenance request

U = Uncertain

E = Extended

Trigger: System

Table 43: Error codes - System

Code	Error text	C	Description	Possible clearance			
S001	Temperature too high	F	Measuring cell temperature too high	When T < 356 °C: Replace electronics unit. When T >= 356 °C: Check plug-in connector on electronics unit. When plug OK: Replace cell.			
			Optic head temperature too high	When T < 356 °C: When housing temperature >= 55 °C: Check housing fan. When housing temperature < 55 °C: Replace electronics unit. When T >= 356 °C: Check plug-in connector on electronics unit. When plug OK: Replace Analyzer module.			
			Temperature of heating for a subassembly too high	Check device documentation to clarify which subassembly is affected. When T < 356 °C: Replace electronics unit. When T >= 356 °C: Check subassembly plug-in connector. When plug OK: Replace subassembly			
			LPMS01 (1/2 control) temperature too high	When housing temperature < 55 °C: Electronics unit fan functioning? Yes: Replace electronics unit. No: Replace Analyzer module. When housing temperature >= 55 °C: Check housing fan.			
			LPMS02 (power electronics) temperature too high	When housing temperature < 55 °C: Replace electronics unit. When housing temperature >= 55 °C: Check housing fan.			
			S002	Temperature too low	F	After x minutes	Check system documentation to clarify which subassembly is affected (heating circuit 1 ..7). <ul style="list-style-type: none"> Temperature displayed < -30 °C: Pt100 short circuit: Replace subassembly For heated sample gas line: Connect reserve Pt100 For analyzer: Replace Analyzer module For optic head: Replace Analyzer module Reset on circuit breaker under electronics unit possible: Check all cables involved for damage (see "Circuit breakers", page 86) Check all plugs are plugged correctly. Reset not possible: Replace subassembly affected

Code	Error text	C	Description	Possible clearance
S004	Flow too low	F	Flow too low	Sample gas flow and instrument air flow too low: Replace cell
				Sample gas flow too low and instrument air flow OK: Gas sampling system defective
				Instrument air flow too low and sample gas flow OK: Check all hose connections. When all hose connections OK: Replace valve block.
S005	Pressure too high	F	Pressure too high	Only instrument air pressure too high: <ul style="list-style-type: none"> Check and set connected instrument air. Set correct pressure on pressure reducer unit.
				Only sample gas pressure too high: <ul style="list-style-type: none"> Set sample gas pressure within device specification
				Instrument air and sample gas pressure too high: <ul style="list-style-type: none"> Exhaust gas hose crimped/blocked Counter-pressure in exhaust duct too high Check all hose connections If this does not work: <ul style="list-style-type: none"> Replace the pressure control module Otherwise: Replace Analyzer module
S006	Pressure too low	F	Pressure too low	Replace pressure control module.
S008	Chopper	F		24 V power supply malfunction: Replace electronics unit. 24 V power supply OK: Replace Analyzer module.
S009	Motor filter wheel 1	F	Filter wheel motor does not detect reference position	24 V power supply malfunction: Replace electronics unit. 24 V power supply OK: Replace Analyzer module.
S010	Motor filter wheel 2			
S011	Motor filter wheel 3			
S012	Emitter	F		Emitter voltage incorrect: Replace electronics unit. Emitter voltage OK and emitter power incorrect: Replace emitter.
S013	5 Volt power	F		Replace electronics unit.
S014	24 Volt power	F		Replace electronics unit.
S015	Detector signal	F		Replace Analyzer module.
S016	Ref. energy too low	F		If further error messages are pending: Clear corresponding error. If no further error messages are pending: Replace cell.
S024	No active component	F	When all "active" checkmarks of all components are inactive	Check in SOPAS ET.
S025	Evaluation module failure	F	Evaluation module could not be started	"Load backup": Menu Maintenance/Save parameters.
S026	Evaluation mod. file error	F	Files for Evaluation module not created (espec, config, condition, measval)	If error remains: "Load default setting" . If error remains: Replace electronics unit.

Code	Error text	C	Description	Possible clearance
S033	Dev. zero point too high	M	Configured for measuring component	Check zero gas for pressure and cleanness. Perform maintenance on compressed air conditioning unit Perform manual zero point adjustment (menu: Adjustment/Zero point). If deviation still too high: Replace Analyzer module
S034	Configuration I/O module	M	CONF (I/O) configuration error, module found does not correspond to nominal configuration	Check I/O module, check configuration: IO hardware plan
S035	Ref. energy too low	M		If further error messages are pending: Clear corresponding error. If no further error messages are pending: Replace cell.
S036	O2 sensor failure	M	Error bit O2 Error=1	Please contact SICK Customer Service
S038	Channel 1 error	M	OVO (I/O) signals that the desired current is not reached on Analog module connection (node y, module z).	Check I/O module, cable damage
S039	Channel 2 error	M		
S040	Flow too high	M	Flow too high	Test pressure sensors with program "Maintenance/Maint Sys./Test pressure sensors". If this does not work: Replace pressure control module.
S041	Flow too low	M	Flow too low	Please contact SICK Customer Service
S042	Controller IO or HC busy	M	BSY (I/O and HC3X) signals that the module microcontroller is still executing the previous command	
S043	Emitter weak	M		Replace emitter.
S045	dev. span gas adjust too high	M	When F_Medium calculation is refused because outside tolerable range; Configured for measuring component	Perform adjustment with zero gas and span gas. If error remains: Replace Analyzer module.
S046	dev. Int. adjust too high	M	When F_Medium calculation is refused because outside tolerable range; Configured for measuring component	Perform "Internal reference" adjustment. If error remains: Replace Analyzer module.
S047	dev. O2 adjust too high	M	When F_Medium calculation is refused because outside tolerable range; Configured for measuring component	Check span gas, check entry for span gas concentration.
S048	alarm O2 measure value	M		
S049	FlashCard not recognized	M	FlashCard not recognized	Please contact SICK Customer Service
S050	adjust factor is Zero	M	If one of factors F_Medium or F_Filter in range $-0,000001 < x < 0,000001$	Check span gas, check entry for span gas concentration
S057	Energy too high	U	When at least one energy value $> 5 * \text{Energie-MAX}$	Please contact SICK Customer Service
S058	Energy too low	U	Energy too low	If a further emitter error is pending: Replace emitter. Otherwise replace Analyzer module
S072	Module not found	E	I/O (EXIST)	Please contact SICK Customer Service
S089	Zero	E	New zero recorded	Extinction value set to zero is displayed
S090	AF	E	F_Filter has been recalculated	New factor determined and measured value from adjustment displayed
S091	Communication problem	E	Internal communication problem	Please contact SICK Customer Service
S092	Adjustment canceled	E	Adjustment canceled	Restart adjustment. If this does not work: Please contact SICK Customer Service
S093	Dark measurement	E		
S094	System start	E		
S095	Adjust. zero canceled	E		
S096	Backup done	E		

Code	Error text	C	Description	Possible clearance
S097	Backup denied	E		
S098	AM	E		
S112	failure IO-Node	E		
S113	Check sum error	F	BCK (I/O) shows the transfer made from Master to Slave (controller) had an incorrect checksum and the Slave did not save the data.	Check I/O module, cable damage
S114	Communication error	F	COM (I/O) communication error with an /I/O module.	
S115	High/low voltage	F	PFO (I/O) signals the internal voltage monitoring of the 5 V and 24 V supply voltages exceed or underflow a range.	Please contact SICK Customer Service
S116	Output without current	F	TOO (HC3X)	

This Table contains solution proposals that can only be processed by specially trained personnel.

Trigger: Evaluation process

Table 44: Error codes - Evaluation process

Code	Error text	C	Possible clearance
E001	Operating system error	U	Please contact SICK Customer Service
E002	Temp. too low		
E003	Incorrect configuration		
E004	Incorrect configuration		
E005	Internal file error		
E006	Incorrect configuration		
E007	Internal file error		
...			
E009			
E010	Incorrect configuration		
...			
E012			
E013	Internal file error		
...			
E021			
E022	Resolution too high/low		
E023	Numeric error		
E024	Incorrect configuration		
E025	Internal file error		
E026	Numeric error		
E027	Incorrect configuration		
E028	Incorrect configuration		
E029	Unknown error		
E030	Operating system error		
E031	Operating system error		
E032	Internal file error		
...			
E034			
E035	Numeric error		
E036	Syntax error		
E037	Error during processing		
E038	Extinction too high		
E039	Internal file error		
E040	Internal file error		
E097	Evaluation uncertain		
E098	Medium temp. too high/low		
E099	Medium pressure too high/low		
E100	Medium flow too high/low		
E101	Measured value too high/low		
E102	Evaluation uncertain		
E103	Evaluation uncertain		

Trigger: Sequence control programs

Table 45: Error codes - Sequence control program

Code	Triggered by sub-assembly	C	Message	Clearance
M001 ... M009	Internal heating	F	Alarm from "device"	" device " = triggering subassembly Clearance see above: S001 and S002
M010 ... M029	External heating	F	Alarm from "device"	" device " = triggering subassembly Clearance see above: S001 and S002
M034 ... M045	System	X	System xx disabled by user	No action required
M046 ... M057	Measuring point 1 ... Measuring point 12	M	Flow alarm (measuring)	Clearance see above: S004 Next measuring point activation after message acknowledged

Table 46: Further error codes

Code	Triggered by sub-assembly	C	Message	Clearance
M058	System	F	Flow alarm (measuring)	Clearance see above: S004 Next measuring point activation after message acknowledged
M060	Program	M	Adjust zero not started	No action necessary
M062	Leak tightness check	X	Test passed	Repeat test and observe messages displayed; Check seating of connections, disconnect heating hose from cell and close sample gas inlet off with dummy plug (from leak tightness check set) If leaky: Exchange pressure control module and cell otherwise exchange gas sampling system
M063		M	Test failed	
M064			Pressure not reached	
M065			Air valve not closed	
M066			Leakage > Limit	
M067		X	Deviation="xx"	Serves as information "xx" = pressure loss [hPa] during measuring time.

Table 47: Further error codes

Code	Triggered by sub-assembly	C	Message	Clearance
M069	Debug	X	Internal message	No action necessary
M070	Light Source	M	Lifetime exceeded	Replace emitter
M071	Filter Unit	M	Lifetime filter exceeded	Replace gas sampling system filter
M072	Valve driver module	F	Temperature > Limit	Other temperature error pending? Then see S001 above; Otherwise replace valve block
M073	Power Supply	X	115V	Serves as information No action necessary

Code	Triggered by sub-assembly	C	Message	Clearance
M074	Program	X	Stop by internal failure	No action necessary
M075		X	Cancelled by user	No action necessary
M076	CELL	M	Lifetime filter exceeded	Replace cell inlet filter

Table 48: Further error codes

Code	Triggered by sub-assembly	C	Message	Clearance
M086	Pressure	X	Sensors ok	No action necessary
M087		X	Sensors adjusted	
M088		M	Sensors not OK	Sample gas outlet open to environment? If no blockages: Exchange pressure control module
M089	Measuring point	M	All disabled	See additional message: Clear pending error; check external signal
M090 ... M101	System	X	Measuring sample point 1 ... Measuring sample point 12	No action necessary
M102 ... M113		X	SP1 disabled by ext signal ... SP12 disabled by ext signal	

11.4 Tags (variable names)

Tags (name) signify states and variables.

The following Table lists tags relevant for the Measuring screens.

Table 49: Tags

Tag	Description	R/W ¹	I/R/B ²
Operating state			
S	Operating state of MARSIC300	R/W 1 = Initializing 2 = Heating 3 = Measuring 4 = Manual 5 = System stop	I
Meas. value			
MV _i (i=1..6)	Concentration (corrected with all factors) i at the measuring point currently active	R	R
MV _i CU (i=1..6)	Concentration (not corrected) i at the measuring point currently active	R	R
MV _i AU (i=1..6)	Absorption (not corrected) i at the measuring point currently active	R	R
MV _i AC (i=1..6)	Extinction (corrected after cross-sensitivity correction) i at the measuring point currently active	R	R
Variables			
RV01..RV80	Floating point number	R	R

Tag	Description	R/W ¹	I/R/B ²
BV01..BV150	Boolean variable	R	B
FV01..FV20	Filter value	R	R
LV01..LV20	Limit value exceeded	R 0 = within limit value 1 = limit value exceeded	B
Input/output interfaces			
AO _i (i=1..20)	Physical value output (scaled)	R	R
AO _i O (i=1..20)	Direct value for current output 0..20 mA in mA	R	R
AO _i OR (i=1..20)	Current active display range	R 0 = measuring range 1 1 = measuring range 2	B
AI _i (i=1..48)	Read in and converted physical value	R/W	R
AI _i I (i=1..48)	Direct value for current input 0..20 mA in mA	R/W	R
DO _i (i=1..128)	Triggering signal for digital output before an inversion that may be set	R	B
DO _i O (i=1..128)	Direct relay state for switching signal output R	R	B
DI _i (i=1..64)	Input signal after an inversion that may be set	R/W	B
Heating control			
HC _i (i=1..2)	Actual value (temperature) of the internal heating control i	R	R
HCPi (i=1..2)	Actual value of internal PID heating control i in the configured unit	R	R
HCPiC (i=1..2)	Actual value of internal PID heating control i in °C	R	R

¹ R = read, W = write

² I = integer value, R = real value, B = Boolean value

12 Index

A

Acknowledging messages.....	72
Adjustment factors.....	51
Automatic adjustment.....	52

B

Backing up the logbook with SOPAS ET.....	41
Bar graph.....	48

C

Checklist for mechanical and electrical installation.....	10
Circuit breakers.....	86
Connect Ethernet.....	24
Connecting the signal lines.....	19
Connecting the tube bundle cable to the analyzer.....	16
Connect instrument air	21
Connections.....	83
Connect power supply	23
Connect sample gas outlet.....	22
Connect signal line.....	24
Connect span gas.....	22
Control values.....	62
Counter format	60
Counters (in menus).....	37

D

data storage.....	44
Dimensional drawings.....	78
downwards counter	37

E

Error messages.....	93
External signals.....	64

F

Fuses.....	83
------------	----

G

Gas flow plan.....	89
--------------------	----

I

Initial start-up.....	37
Installation.....	8
Installing the gas sampling system.....	25
Instrument display.....	60
Intensity.....	63
Interfaces.....	82
Internal adjustment drift.....	62
IP address.....	39, 67, 68
IP configuration.....	61

L

Language.....	61
Leak tightness check.....	75
Leak tightness check with pressure test tool.....	76
limit values	65
Line Writer	44, 46, 49
Loading/saving the parameters.....	72
Loading/saving the parameters after replacing the analyzer.....	73
Loading/saving the parameters after replacing the electronics.....	74
Logbook.....	59, 66

M

Manual adjustment.....	52
Measured value box.....	44, 48
Measuring point switchover.....	52
Menu tree (SOPAS ET).....	42
Modbus-Profibus converter.....	32
Modbus-Profinet converter.....	27
Modbus values.....	57

O

O2 sensor.....	59
of the tube bundle cable sheath.....	17
Operating state.....	67, 68, 69

P

Parameterization Measuring Screen.....	60
password	60
Passwords.....	41
Power supply.....	82, 82
Power supply - connection.....	83
pressure tool.....	9
Push-in fitting	9

R

Reference energy.....	62
Restart.....	71

S

Sample gas conditions.....	80
sample gas line.....	81
sample gas line to analyzer.....	14
Saving parameters.....	40
Scaling Measuring screens.....	45
Scope of delivery.....	9
Sequence control program.....	52
Serial number.....	67, 68
Service log.....	71
Set the IP address	37
Signals.....	63
Software SOPAS ET.....	39
Software version.....	67, 68
SOPAS ET.....	6, 39
Span gas (definition).....	8
Span gas drift.....	62
Standby.....	70
Start a leak tightness check.....	71
Start times.....	51
Status.....	67, 68, 68
System info.....	67, 68
System name.....	61
system parameters.....	60
system status	67, 68, 68

T

Tags (variable names.....)	100
Technical data.....	78
Temperature control.....	58
Test digital I/O.....	69
Test gas (definition).....	8
test gases	51
time	61
Torques.....	87
Tube bundle cable.....	81
Tube screw fitting.....	9

Z

Zero drift.....	62
Zero gas (definition).....	8
zero gas quality.....	87

Australia

Phone +61 3 9457 0600
1800 334 802 - tollfree
E-Mail sales@sick.com.au

Austria

Phone +43 22 36 62 28 8-0
E-Mail office@sick.at

Belgium/Luxembourg

Phone +32 2 466 55 66
E-Mail info@sick.be

Brazil

Phone +55 11 3215-4900
E-Mail marketing@sick.com.br

Canada

Phone +1 905 771 14 44
E-Mail information@sick.com

Czech Republic

Phone +420 2 57 91 18 50
E-Mail sick@sick.cz

Chile

Phone +56 2 2274 7430
E-Mail info@schadler.com

China

Phone +86 20 2882 3600
E-Mail info.china@sick.net.cn

Denmark

Phone +45 45 82 64 00
E-Mail sick@sick.dk

Finland

Phone +358-9-2515 800
E-Mail sick@sick.fi

France

Phone +33 1 64 62 35 00
E-Mail info@sick.fr

Germany

Phone +49 211 5301-301
E-Mail info@sick.de

Hong Kong

Phone +852 2153 6300
E-Mail ghk@sick.com.hk

Hungary

Phone +36 1 371 2680
E-Mail office@sick.hu

India

Phone +91 22 6119 8900
E-Mail info@sick-india.com

Israel

Phone +972 4 6881000
E-Mail info@sick-sensors.com

Italy

Phone +39 02 274341
E-Mail info@sick.it

Japan

Phone +81 3 5309 2112
E-Mail support@sick.jp

Malaysia

Phone +6 03 8080 7425
E-Mail enquiry.my@sick.com

Mexico

Phone +52 (472) 748 9451
E-Mail mario.garcia@sick.com

Netherlands

Phone +31 30 2044 000
E-Mail info@sick.nl

New Zealand

Phone +64 9 415 0459
0800 222 278 - tollfree
E-Mail sales@sick.co.nz

Norway

Phone +47 67 81 50 00
E-Mail sick@sick.no

Poland

Phone +48 22 539 41 00
E-Mail info@sick.pl

Romania

Phone +40 356 171 120
E-Mail office@sick.ro

Russia

Phone +7 495 775 05 30
E-Mail info@sick.ru

Singapore

Phone +65 6744 3732
E-Mail sales.gsg@sick.com

Slovakia

Phone +421 482 901201
E-Mail mail@sick-sk.sk

Slovenia

Phone +386 591 788 49
E-Mail office@sick.si

South Africa

Phone +27 11 472 3733
E-Mail info@sickautomation.co.za

South Korea

Phone +82 2 786 6321
E-Mail info@sickkorea.net

Spain

Phone +34 93 480 31 00
E-Mail info@sick.es

Sweden

Phone +46 10 110 10 00
E-Mail info@sick.se

Switzerland

Phone +41 41 619 29 39
E-Mail contact@sick.ch

Taiwan

Phone +886 2 2375-6288
E-Mail sales@sick.com.tw

Thailand

Phone +66 2645 0009
E-Mail Ronnie.Lim@sick.com

Turkey

Phone +90 216 528 50 00
E-Mail info@sick.com.tr

United Arab Emirates

Phone +971 4 88 65 878
E-Mail info@sick.ae

United Kingdom

Phone +44 1727 831121
E-Mail info@sick.co.uk

USA

Phone +1 800 325 7425
E-Mail info@sick.com

Vietnam

Phone +84 945452999
E-Mail Ngo.Duy.Linh@sick.com

Further locations at www.sick.com