



## UC30

Rugged. Reliable. Rectangular.

**SICK**  
Sensor Intelligence.

## Advantages



## Virtually unlimited use – regardless of color, gloss, and transparency

**SICK ultrasonic sensors perform measurement and detection tasks in a wide variety of application areas on colored, shiny, or transparent surfaces, which are particularly challenging for optical sensors. Even adverse ambient conditions such as dust, dirt, or fog hardly affect the measurement result. The broad detection range also allows for a large field to be monitored with just one sensor – with a measuring range of 13 mm to 8 m. No matter where they are: the ultrasonic sensors from SICK are at your side in any industry. The extensive product portfolio offers you a wide range of solutions for your application. See for yourself.**

**Find out more about the principle of operation of the ultrasonic sensors.**

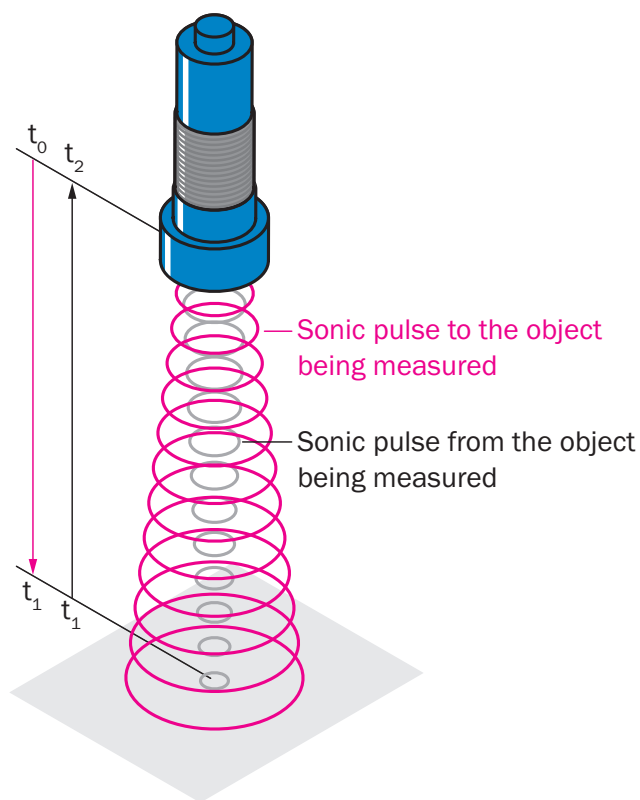

#### (Acoustic) time-of-flight measurement

The sensor emits an acoustic pulse that is reflected by the object being detected. The time required for the pulse to go from the sensor to the object and come back again is measured, evaluated and converted into the distance as follows.

Distance = speed of sound x total acoustic time of flight (t2) / 2

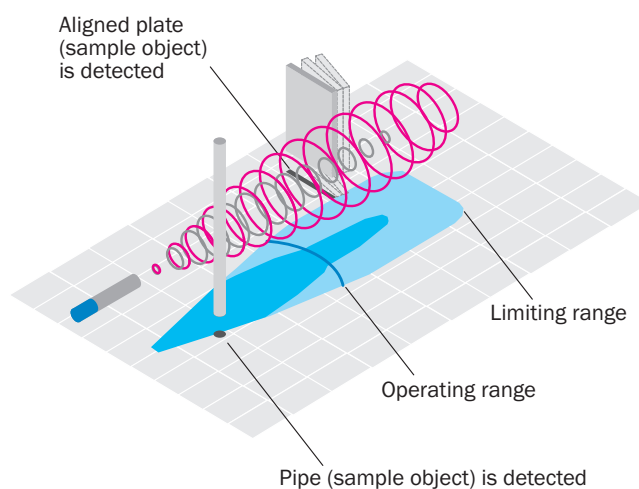

#### Scanning range of ultrasonic sensors

In general on ultrasonic sensors, the less sound the object being measured absorbs, the greater the possible scanning range. The operating range specifies the distance up to which measurement on common objects with sufficient operating reserves is possible. Under ideal conditions, the sensor can even be used up to its limiting range. Switch panels are used for ideal assessment of application capability. The dark blue area shown in these switch panels shows an example of the sensor's working range if a round rod is detected. The light blue area shows the maximum detection range (limiting range) which can be achieved under ideal conditions for easily detectable objects, such as the aligned plate given here. This area between the sensor and the measuring object should be kept free of other objects to prevent them from being detected accidentally. The detectability and detection range of an object depend on its reflective properties, size, and alignment. Depending on the application, the sensor may also be able to detect very small objects, e.g. metal wire.



## Applications in focus

Ultrasonic sensors are true all-rounders. SICK ultrasonic sensors demonstrate their reliability and precision in virtually any application, from measuring distances or detecting solid, powdered, or liquid media. No matter the industry, no matter the application.

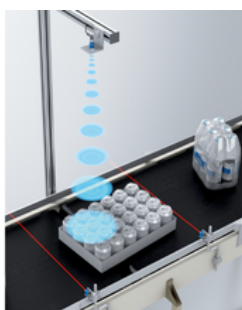
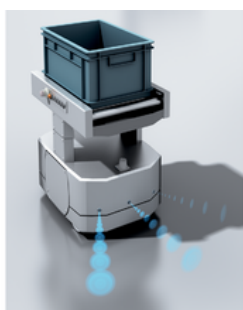

**SICK ultrasonic sensors show their strengths in the contact-free detection of objects in all imaginable applications. These all-rounders reliably and precisely master all automation requirements on your processes.**

## Individually adjustable sonic beams – the optimal solution for your application and unique in the market

Adjusting the sensor sensitivity gives you direct control of the sonic beam's behavior and, therefore, the sensor's detection range. This means objects in the environment can be displayed or blanked – with infinite adjustment.

It doesn't matter whether the sonic beam is large or small, narrow or wide, or whether the detection range is slowly increasing or the largest size possible. Tank walls, for example, can be blanked in level applications, different container sizes can be verified when inspecting empty containers, and even larger areas can be monitored with just one sensor.

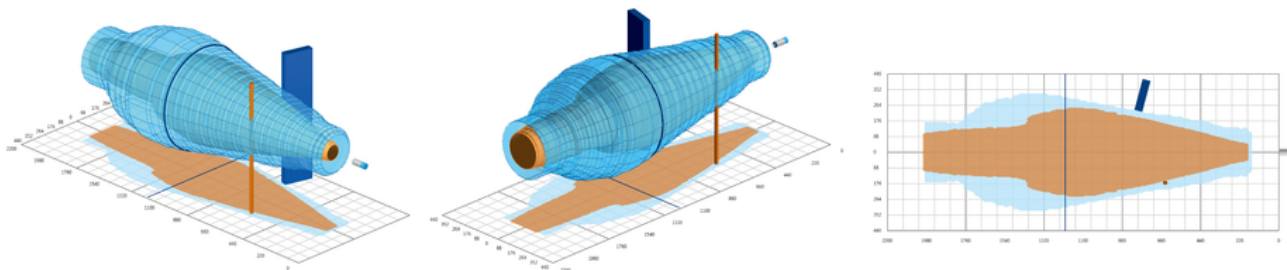

**The infinitely and individually adjustable detection range is the optimal solution for your application. If the ambient conditions change, the sensor can be quickly and easily adjusted to the new requirements. Thanks to the Connect+ software or the SOPAS Engineering Tool from SICK, there are practically no limits to the adjustment options.**

## IO-Link

**As a co-founder of IO-Link, SICK offers one of the broadest IO-Link portfolios on the market. Smart Sensors with IO-Link generate and receive data and information which goes beyond conventional switching signals or measured process parameters.**

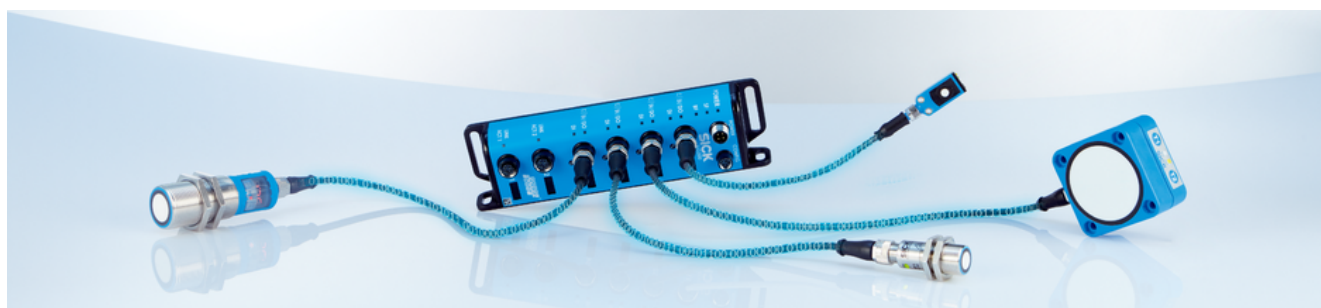

### Your advantages at a glance

- Sensor integration at fieldbus level offers integrated communication to increase system productivity
  - Easy device replacement with automatic parameterization increases machine availability
  - Interference-proof signal transmission increases system reliability
  - Automatic sensor configuration according to the manufacturing process increases flexibility within the application
  - Minimal cabling and use of unshielded cables reduces the cost of projects
  - Visualization on a PC provides a clear overview of the sensor functionality, making it the optimal solution for your application
  - Several diagnostic options, e.g. when signal strength decreases, to avoid downtime and to enable planning
  - Automated electronic parts lists using device IDs simplify the documentation process, reducing associated costs
- Speak to your contact person at SICK or [click here](#).



**IO-Link solves the problem of clearing those final hurdles in the communication chain by seamlessly integrating sensors into an automation net-**

work. This brings about new ways of increasing flexibility, reliability, and efficiency and can reduce the costs associated with your system.

## SICK LifeTime Services

SICK's services increase machine and plant productivity, enhance the safety of people all over the world, provide a solid foundation for a sustainable business operation, and protect investment goods. In addition to its usual consulting services, SICK provides direct on-site support during the conceptual design and commissioning phases as well as during operation.

The range of services not only covers aspects like maintenance and inspection, but also includes performance checks as well as upgrades and retrofits. Modular or customized service contracts extend the service life of plants and therefore increase their availability. If faults occur or limit values are exceeded, these are detected at all times by the corresponding sensors and systems.

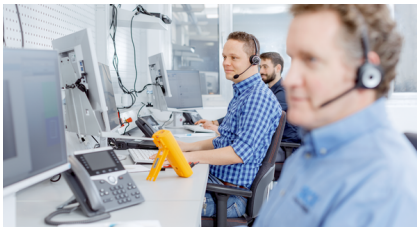

### Consulting and design

Application-specific advice on the product, its integration and the application itself.



### commissioning and maintenance

Application-optimized and sustainable — thanks to professional commissioning and maintenance by a trained SICK service technician.



### service contracts

Extended warranty, SICK Remote Service, 24-hour helpdesk, maintenance, availability guarantees and other modular components can be individually combined on request.



## Technical data overview

<b>Measuring range</b>	Operating range	350 mm ... 6,000 mm (depending on type)
	Limiting range	5,000 mm / 8,000 mm (depending on type)
<b>Resolution</b>		≥ 0.18 mm
<b>Repeatability</b>		± 0.15 %
<b>Response time</b>		180 ms ... 240 ms 180 ms ... 240 ms <sup>1)</sup>
<b>Output time</b>		43 ms ... 60 ms (depending on type)
<b>Switching frequency</b>		4 Hz / 3 Hz (depending on type)
<b>Analog output</b>		4 mA ... 20 mA, ≤ 500 Ω <sup>2)</sup> 0 V ... 10 V, ≥ 100,000 Ω
<b>Digital output</b>	Type	PNP / NPN / push-pull: PNP/NPN (depending on type)
-		
<b>IO-Link</b>		✓, IO-Link V1.1
<b>Enclosure rating</b>		IP65 / IP67
<b>Sending axis</b>		Straight
<b>Ambient temperature, operation</b>		-25 °C ... +70 °C

<sup>1)</sup> Subsequent smoothing of the analog output, depending on the application, may increase the response time by up to 200 %.

<sup>2)</sup> For 4 mA ... 20 mA and  $V_S \leq 20$  V max. load ≤ 100 Ω.

## Product description

The sensors of the UC30 product family impress with excellent performance in a compact cubic housing. Due to color-independent detection, high contamination tolerance and outstanding background suppression, UC30 sensors deliver stable measurement results even under challenging conditions. Various output signals with sensing ranges of up to 8,000 mm as well as high measurement accuracy due to the integrated temperature compensation leave no applications unsolved. Teach-in buttons and IO-Link also extend the diagnostic and configuration options of these ultrasonic sensors.

## At a glance

- Reliable measurement, regardless of material color, transparency, gloss, or ambient light
- Rugged housing with teach-in buttons
- Sensing ranges up to 8,000 mm
- Analog output, push-pull digital output with IO-Link or two PNP/NPN digital outputs
- Immune to dirt, dust, humidity, and fog
- Adjustable sensitivity

## Your benefits

- Compact cubic housing for straightforward machine integration
- Rugged, plastic housing ensures highest plant availability
- Various output signals for solving complex applications available
- IO-Link with many diagnostic options for fault-free operation and simple maintenance
- Teach-in buttons for fast and easy commissioning
- Rugged ultrasonic technology, measures reliably even in dirty, dusty, humid, and foggy conditions
- Integrated temperature compensation ensures high measurement accuracy at all times for optimum process quality

## Fields of application

- Level regulation for liquids and bulk materials
- Detection, measurement and positioning of dark, shiny, and transparent materials
- Diameter check for metal, paper, and plastic coils
- Continuous detection of fabrics and wire grids
- Collision avoidance
- Outdoor applications

## Ordering information

Other models and accessories → [www.sick.com/UC30](http://www.sick.com/UC30)

- **Communication interface:** -
- **Operating range, limiting range:** 350 mm ... 3,400 mm, 5,000 mm
- **Connection type:** male connector, M12, 5-pin
- **Sending axis:** straight

Response time	Digital output	Type of analog output	Type	Part no.
180 ms	2 x NPN	-	UC30-214164	6054713
	2 x PNP	-	UC30-214162	6054711
180 ms <sup>1)</sup>	-	Current output / voltage output	UC30-214163	6054712

<sup>1)</sup> Subsequent smoothing of the analog output, depending on the application, may increase the response time by up to 200 %.

- **Communication interface:** IO-Link
- **Operating range, limiting range:** 350 mm ... 3,400 mm, 5,000 mm
- **Connection type:** male connector, M12, 5-pin
- **Sending axis:** straight

Response time	Digital output	Communication Interface detail	Type	Part no.
180 ms	1 x push-pull: PNP/NPN	IO-Link V1.1	UC30-21416B	6068452

- **Communication interface:** -
- **Operating range, limiting range:** 600 mm ... 6,000 mm, 8,000 mm
- **Connection type:** male connector, M12, 5-pin
- **Sending axis:** straight

Response time	Digital output	Type of analog output	Type	Part no.
240 ms	2 x NPN	-	UC30-215164	6054717
	2 x PNP	-	UC30-215162	6054715
240 ms <sup>1)</sup>	-	Current output / voltage output	UC30-215163	6054716

<sup>1)</sup> Subsequent smoothing of the analog output, depending on the application, may increase the response time by up to 200 %.

- **Communication interface:** IO-Link
- **Operating range, limiting range:** 600 mm ... 6,000 mm, 8,000 mm
- **Connection type:** male connector, M12, 5-pin
- **Sending axis:** straight

Response time	Digital output	Communication Interface detail	Type	Part no.
240 ms	1 x push-pull: PNP/NPN	IO-Link V1.1	UC30-21516B	6068453



## SICK AT A GLANCE

SICK is one of the leading manufacturers of intelligent sensors and sensor solutions for industrial applications. A unique range of products and services creates the perfect basis for controlling processes securely and efficiently, protecting individuals from accidents and preventing damage to the environment.

We have extensive experience in a wide range of industries and understand their processes and requirements. With intelligent sensors, we can deliver exactly what our customers need. In application centers in Europe, Asia and North America, system solutions are tested and optimized in accordance with customer specifications. All this makes us a reliable supplier and development partner.

Comprehensive services complete our offering: SICK LifeTime Services provide support throughout the machine life cycle and ensure safety and productivity.

For us, that is “Sensor Intelligence.”

## WORLDWIDE PRESENCE:

Contacts and other locations –[www.sick.com](http://www.sick.com)