



WL27-3R2631S02

W27

COMPACT PHOTOELECTRIC SENSORS

SICK
Sensor Intelligence.



Illustration may differ



Ordering information

Type	Part no.
WL27-3R2631S02	1029144

Other models and accessories → www.sick.com/W27

Detailed technical data

Features

Functional principle	Photoelectric retro-reflective sensor
Functional principle detail	With minimum distance to reflector (dual lens system)
Dimensions (W x H x D)	24.6 mm x 80.6 mm x 54 mm
Housing design (light emission)	Rectangular
Sensing range max.	0.1 m ... 15 m ¹⁾
Sensing range	0.1 m ... 11 m ¹⁾
Focus	Approx. 1.5°
Type of light	Visible red light
Light source	LED ²⁾
Light spot size (distance)	Ø 220 mm (10 m)
Angle of dispersion	Approx. 1.5°
Wave length	660 nm
Adjustment	Potentiometer
Special features	Time delay selectable from 0,05 s to 1,0 s

¹⁾ Reflector PL80A.

²⁾ Average service life: 100,000 h at T_U = +25 °C.

Mechanics/electronics

Supply voltage U_B	20 V AC/DC ... 250 V AC/DC ¹⁾
-------------------------------------	--

¹⁾ Limit values.

²⁾ Provide suitable arc suppression for inductive or capacitive loads. Relay contacts are separated from the supply voltage by a basic isolation of 3 mm. Depending on the application, additional isolation might have to be applied in the user's circuit.

³⁾ With light/dark ratio 1:1.

⁴⁾ A = V_S connections reverse-polarity protected.

⁵⁾ C = interference suppression.

⁶⁾ Reference voltage: 250 V AC, overvoltage category 2.

Power consumption	≤ 2.5 VA
Switching output	Relay, electrically isolated ²⁾
Output function	Change-over contacts
Switching mode	Light/dark switching
Switching mode selector	Selectable via time delay selector switch
Switching current (switching voltage)	4 A @ 250 V AC, 4 A @ 24 V DC, 0.125 A @ 250 V DC UL: 4 A @ 250 V AC, general use / 4 A @ 250 V AC, resistive (NO) / 3 A @ 250 V AC, resistive (NC) / 4 A @ 24 V DC, NO, general use / 3 A @ 24 V DC, NC, general use / R300 / B300 (NO contacts only) / 0 °C ... +60 °C
Response time	≤ 10 ms
Switching frequency	10 Hz ³⁾
Time functions	Switch-on delay/off delay/switch on delay and time delay off
Delay time	Adjustable via time delay selector switch, 0.5 s ... 1 s
Connection type	Male connector Q6, 6-pin, AC/UC-coded
Circuit protection	A ⁴⁾ C ⁵⁾
Protection class	II ⁶⁾
Weight	120 g
Polarisation filter	✓
Special device	✓
Housing material	Plastic, ABS
Optics material	Plastic, PMMA
Enclosure rating	IP65
Ambient operating temperature	-40 °C ... +60 °C
Ambient temperature, storage	-40 °C ... +75 °C
UL File No.	NRKH.E181493 & NRKH7.E181493

¹⁾ Limit values.

²⁾ Provide suitable arc suppression for inductive or capacitive loads. Relay contacts are separated from the supply voltage by a basic isolation of 3 mm. Depending on the application, additional isolation might have to be applied in the user's circuit.

³⁾ With light/dark ratio 1:1.

⁴⁾ A = V_S connections reverse-polarity protected.

⁵⁾ C = interference suppression.

⁶⁾ Reference voltage: 250 V AC, overvoltage category 2.

Safety-related parameters

MTTF_D	707 years
DC_{avg}	0 %

Classifications

ECLASS 5.0	27270902
ECLASS 5.1.4	27270902
ECLASS 6.0	27270902
ECLASS 6.2	27270902
ECLASS 7.0	27270902
ECLASS 8.0	27270902

ECLASS 8.1	27270902
ECLASS 9.0	27270902
ECLASS 10.0	27270902
ECLASS 11.0	27270902
ECLASS 12.0	27270902
ETIM 5.0	EC002717
ETIM 6.0	EC002717
ETIM 7.0	EC002717
ETIM 8.0	EC002717
UNSPSC 16.0901	39121528

Adjustments

Potentiometer, time functions, light-/dark-switch

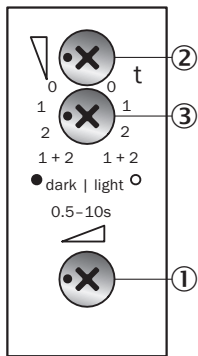

- ① Potentiometer
- ② Time control
- ③ Time delay selector switch

Connection type

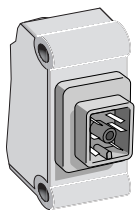

Connection diagram

Cd-181

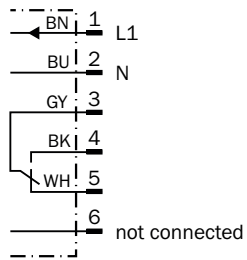

Characteristic curve

WL27-3

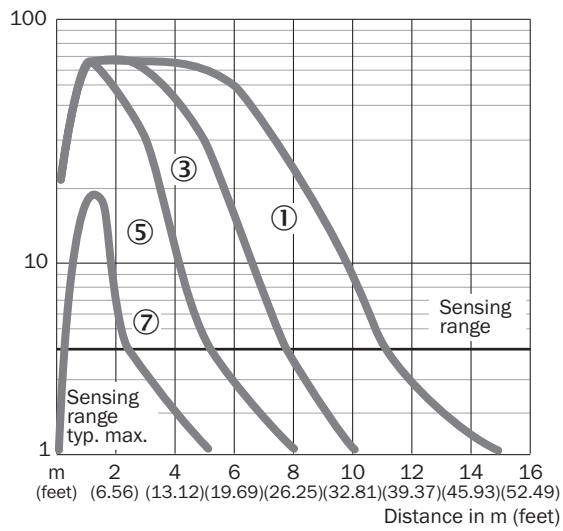

- ① Reflector PL80A
- ③ Reflector PL40A
- ⑤ Reflector PL20A
- ⑦ Reflective tape Diamond Grade

Sensing range diagram

WL27-3

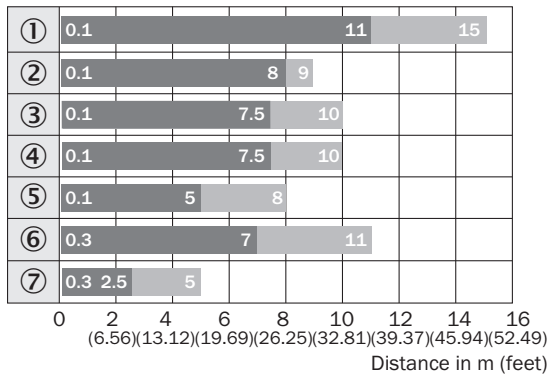

■ Sensing range ■ Sensing range max.

- ① Reflector PL80A
- ② Reflector PL50A
- ③ Reflector PL40A
- ④ Reflector PL30A
- ⑤ Reflector PL20A
- ⑥ Reflector C110A
- ⑦ Reflective tape Diamond Grade

Dimensional drawing (Dimensions in mm (inch))



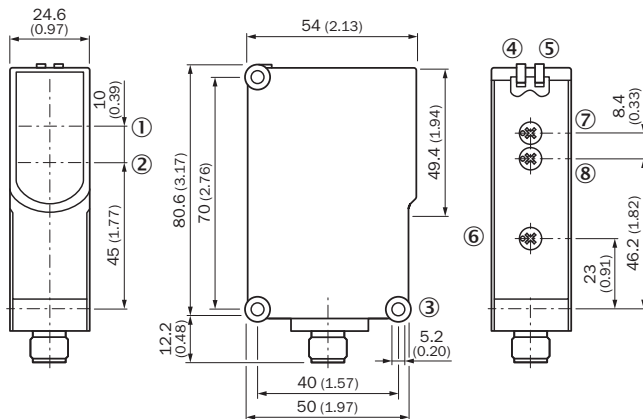

WL27-3, WSE27-3, potentiometer, time functions



- ① Optical axis, sender
- ② Optical axis, receiver
- ③ Mounting hole \varnothing 5.2 mm
- ④ LED indicator green: Supply voltage active
- ⑤ LED indicator yellow: Status of received light beam
- ⑥ Sensitivity control (10 revolutions)
- ⑦ Time control
- ⑧ Time delay selector switch

Recommended accessories

Other models and accessories → www.sick.com/W27

	Brief description	Type	Part no.
Device protection (mechanical)			
	Protective housing for W26, W27-3 and mounting rods with diameter 12 mm ... 20 mm, Zinc plated steel (protective housing), Zinc die cast (clamping bracket), Universal clamp BEF-KHS-KH1 (2022726), mounting hardware	BEF-SG-W27	2039601
Mounting brackets and plates			
	Universal mounting bracket for reflectors, steel, zinc coated	BEF-WN-REFX	2064574
Reflectors			
	Rectangular, screw connection, 84 mm x 84 mm, PMMA/ABS, Screw-on, 2 hole mounting	PL80A	1003865
Others			
	<ul style="list-style-type: none"> • Connection type head A: Female connector, 6-pin, angled, AC/UC-coded • Connection type head B: Flying leads • Signal type: Sensor/actuator cable • Cable: 2 m, PVC • Description: Sensor/actuator cable, unshielded 	DOL-1406-W02M	6030221

SICK AT A GLANCE

SICK is one of the leading manufacturers of intelligent sensors and sensor solutions for industrial applications. A unique range of products and services creates the perfect basis for controlling processes securely and efficiently, protecting individuals from accidents and preventing damage to the environment.

We have extensive experience in a wide range of industries and understand their processes and requirements. With intelligent sensors, we can deliver exactly what our customers need. In application centers in Europe, Asia and North America, system solutions are tested and optimized in accordance with customer specifications. All this makes us a reliable supplier and development partner.

Comprehensive services complete our offering: SICK LifeTime Services provide support throughout the machine life cycle and ensure safety and productivity.

For us, that is “Sensor Intelligence.”

WORLDWIDE PRESENCE:

Contacts and other locations –www.sick.com