



Ordering information

Type	Part no.
LMS122-10000 Security	1044322

Other models and accessories → www.sick.com/LMS1xx



Detailed technical data

Features

Application	Security, Indoor
Light source	Infrared (905 nm)
Laser class	1 (IEC 60825-1:2014, EN 60825-1:2014)
Aperture angle	Horizontal 270°
Scanning frequency	25 Hz 50 Hz
Angular resolution	Horizontal 0.25°, 0.5°
Heating	No
Working range	0.5 m ... 20 m
Scanning range	At 10% remission factor 18 m At 90% remission factor 20 m
Amount of evaluated echoes	2
Fog correction	Yes

Mechanics/electronics

Connection type	1 x system plug with screw terminal block
Supply voltage	9 V DC ... 30 V DC
Power consumption	Typ. 8 W
Housing color	Black (RAL 9005)
Enclosure rating	IP65 (EN 60529, Section 14.2.5)
Protection class	III (EN 50178 (1997;10))
Weight	1.1 kg
Dimensions (L x W x H)	105 mm x 102 mm x 152 mm
MTBF	> 100 years

Safety-related parameters

MTTF_D	> 100 years
-------------------------	-------------

Performance

Response time	≥ 20 ms
Detectable object shape	Almost any
Systematic error	± 30 mm ¹⁾
Statistical error	12 mm ¹⁾
Integrated application	Field evaluation Security conform parameterization Easy Teach lite and pro
Number of field sets	10 fields
Simultaneous evaluation cases	10

¹⁾ Typical value; actual value depends on environmental conditions.

Interfaces

Ethernet	✓, TCP/IP
Function	Data interface (read result output)
Data transmission rate	10/100 MBit/s
Serial	✓, RS-232
Function	Service interface
Data transmission rate	9.6 kBaud ... 115.2 kBaud
CAN	✓
Function	Extension of outputs
Digital inputs	4 digital
Digital outputs	3 (2 relay, 1 digital)
Optical indicators	7-segment display (plus 5 LEDs showing device status, contamination warning and initial condition)

Ambient data

Object remission	2 % ... > 1,000 % (reflectors)
Electromagnetic compatibility (EMC)	EN 61000-6-2:2005 / EN 61000-6-3:2007+A1:2011
Vibration resistance	EN 60068-2-6 (1995-04)
Shock resistance	EN 60068-2-27 (1993-03)
Ambient operating temperature	0 °C ... +50 °C
Storage temperature	-30 °C ... +70 °C
Ambient light immunity	80,000 lx

General notes

Note on use	The sensor does not constitute a safety component as defined by relevant legislation on machine safety.
--------------------	---

Classifications

ECLASS 5.0	27270990
ECLASS 5.1.4	27270990
ECLASS 6.0	27270913
ECLASS 6.2	27270913

ECLASS 7.0	27270913
ECLASS 8.0	27270913
ECLASS 8.1	27270913
ECLASS 9.0	27270913
ECLASS 10.0	27270913
ECLASS 11.0	27270913
ECLASS 12.0	27270913
ETIM 5.0	EC002550
ETIM 6.0	EC002550
ETIM 7.0	EC002550
ETIM 8.0	EC002550
UNSPSC 16.0901	41111615

Dimensional drawing (Dimensions in mm (inch))

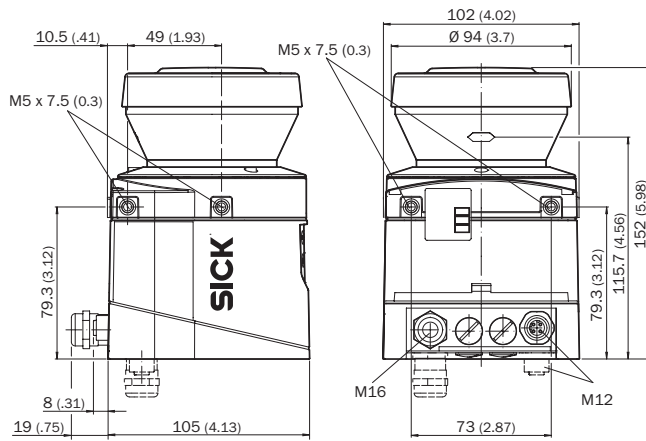

Working range diagram

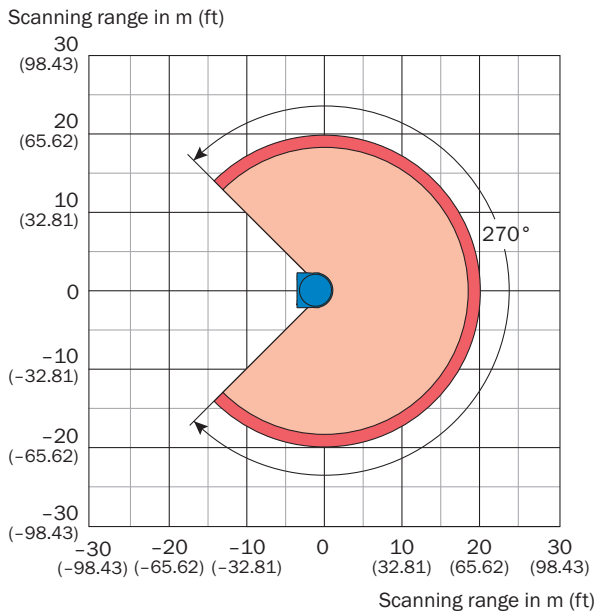

- Scanning range max. 20 m (65.62 ft)
- Scanning range for objects up to 10 % remission 18 m (59.06 ft)

Connection type

Ethernet

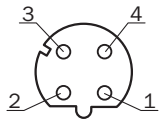

M12 female connector, 4-pin, D-coded

- ① TX+
- ② RX+
- ③ TX-
- ④ RX-

PIN assignment

Service interface

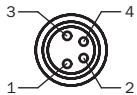





Female connector M8, 4-pin

- ① Reserved
- ② RxD AUX
- ③ GND RS
- ④ TxD AUX

Recommended accessories

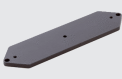
Other models and accessories → www.sick.com/LMS1xx

	Brief description	Type	Part no.
Mounting brackets and plates			
	1 piece, mounting bracket for rear mounting on wall or machine	Mounting kit 1a	2034324
	1 piece, mounting bracket for rear mounting on wall or machine with protection of optics hood	Mounting kit 1b	2034325
	1 piece, mounting bracket, adjustable lateral axis, only in conjunction with mounting kit 1a (2034324) or 1b (2034325)	Mounting kit 2	2039302
	1 piece, mounting plate, adjustable longitudinal axis, only in conjunction with mounting kit 2 (2039302)	Mounting kit 3	2039303
Others			
	<ul style="list-style-type: none"> • Connection type head A: Male connector, M12, 4-pin, straight, D-coded • Connection type head B: Male connector, RJ45, 4-pin, straight • Signal type: Ethernet, PROFINET • Cable: 5 m, 4-wire, PUR, halogen-free • Description: Ethernet, PROFINET, shielded • Application: Drag chain operation, Zones with oils and lubricants 	YM2D24-050PN1MRJA4	2106184
	<ul style="list-style-type: none"> • Connection type head A: Flying leads • Connection type head B: Flying leads • Items supplied: By the meter • Cable: 15-wire, AWG20, PVC • Description: Unshielded • Note: On 100 m reel 	Connecting cable	6030795

Recommended services

Additional services → www.sick.com/LMS1xx

	Type	Part no.
Maintenance		
<ul style="list-style-type: none"> • Product area: 2D LiDAR sensors, 3D LiDAR sensors • Range of services: Inspection, analysis and restoring of defined functions, Inspection and adaptation of basic settings, parameters of field application, filters for raw data output, and product-specific configuration • Duration: Additional work will be invoiced separately 	Maintenance of LiDAR sensors	1682593
Commissioning		
<ul style="list-style-type: none"> • Product area: 2D LiDAR sensors, 3D LiDAR sensors • Range of services: Inspection of connection, fine adjustment, configuration of monitored areas, configuration and optimization of parameters as well as tests, Setup of previously defined functions of basic settings, parameters of field application, filters for raw data output and product-specific configuration • Duration: Additional work will be invoiced separately 	Commissioning LiDAR sensors	1680672

	Type	Part no.
Extended warranty		
<ul style="list-style-type: none">• Product area: Machine vision, LiDAR sensors, safety camera sensors, Safety laser scanners, Safety radar sensors, Radar sensors, Fixed mount barcode scanners, Image-based code readers, RFID, Mobile handheld scanners• Range of services: The services correspond to the scope of the statutory manufacturer warranty (SICK general terms of delivery).• Duration: Five-year warranty from delivery date.	Extended warranty for a total of five years from delivery date	1680671

SICK AT A GLANCE

SICK is one of the leading manufacturers of intelligent sensors and sensor solutions for industrial applications. A unique range of products and services creates the perfect basis for controlling processes securely and efficiently, protecting individuals from accidents and preventing damage to the environment.

We have extensive experience in a wide range of industries and understand their processes and requirements. With intelligent sensors, we can deliver exactly what our customers need. In application centers in Europe, Asia and North America, system solutions are tested and optimized in accordance with customer specifications. All this makes us a reliable supplier and development partner.

Comprehensive services complete our offering: SICK LifeTime Services provide support throughout the machine life cycle and ensure safety and productivity.

For us, that is “Sensor Intelligence.”

WORLDWIDE PRESENCE:

Contacts and other locations –www.sick.com