

IVC-3D11112

IVC-3D

3D MACHINE VISION

SICK
Sensor Intelligence.

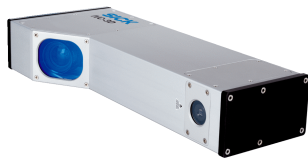

Ordering information

Type	Part no.
IVC-3D11112	1042152

In accordance with Article 2 (4), this product does not fall within the scope of RoHS directive 2011/65/EU and is also not designed for use in products which fall within the scope of this directive. You can find additional information in the product information.

Other models and accessories → www.sick.com/IVC-3D



Detailed technical data

Features

Task	Presence inspection Quality inspection Measuring, 3D
Technology	3D line scanning
Product category	Programmable
Working distance	306 mm ... 683 mm ¹⁾
Example field of view	200 mm x 600 mm
Light source	Internal lighting Laser, Visible, Red, 658 nm, ± 15 nm
Laser class	
Factory calibrated	✓
Width at minimum operating distance	436 mm
Width at maximum operating distance	810 mm
Maximum height range	377 mm
Imaging angle	58°
Offline support	Emulator

¹⁾ The specified values are valid for single device installations. Please see operating instructions for details.

Mechanics/electronics

Connection type	M12, 4-pin female connector, D-coded (Ethernet) M12, 8-pin female connector (RS-485) M12, 8-pin male connector, A-coded (voltage supply, I/O) M12, 5-pin male (Encoder)
Connector material	Nickel plated brass
Supply voltage	24 V DC, ± 20 %
Ripple	< 5 V _{pp}
Current consumption	< 1 A, without output load
Enclosure rating	IP65
Protection class	III
Housing material	Anodized aluminum

Window material	PMMA
Weight	4 kg
Dimensions (L x W x H)	387 mm x 69 mm x 163 mm

Performance

Image sensor	CMOS
Processor	800 MHz
Scan/frame rate	5,000 3D profiles/s
Memory	128 MB RAM, 16 MB flash
Typical height resolution	0.2 mm
3D profile resolution	2,048 points

Interfaces

Ethernet	✓, TCP/IP, UDP/IP
Remark	Including OPC server
Data transmission rate	10/100 MBit/s
EtherNet/IP™	✓
Data transmission rate	10/100 MBit/s
Serial	✓, RS-422, RS-485
Function	Encoder (RS-422)
Data transmission rate	Maximum encoder frequency: 2 MHz
Operator interfaces	Application-specific user interfaces can be set up as stand-alone web pages. The integrated OPC server supports data exchange with SCADA systems, for example.
Configuration software	IVC Studio
Data storage and retrieval	Images and data can be stored to and retrieved from flash and external FTP servers
Digital input	3 program controlled inputs (1 trigger input), HIGH = 10 V ... 28.8 V
Digital output	3 programmable type B digital outputs, Max. output current 100 mA, trigger output
Encoder interface	RS-422
Maximum encoder frequency	2 MHz

Ambient data

Shock load	15 g, 3 x 6 directions
Vibration load	5 g, 58 Hz ... 150 Hz
Ambient operating temperature	0 °C ... +40 °C
Storage temperature	-20 °C ... +70 °C

Classifications

eCI@ss 5.0	27310205
eCI@ss 5.1.4	27310205
eCI@ss 6.0	27310205
eCI@ss 6.2	27310205
eCI@ss 7.0	27310205
eCI@ss 8.0	27310205
eCI@ss 8.1	27310205
eCI@ss 9.0	27310205

eCl@ss 10.0	27310205
eCl@ss 11.0	27310205
eCl@ss 12.0	27310205
ETIM 5.0	EC001820
ETIM 6.0	EC001820
ETIM 7.0	EC001820
ETIM 8.0	EC001820
UNSPSC 16.0901	43211731

Dimensional drawing (Dimensions in mm (inch))

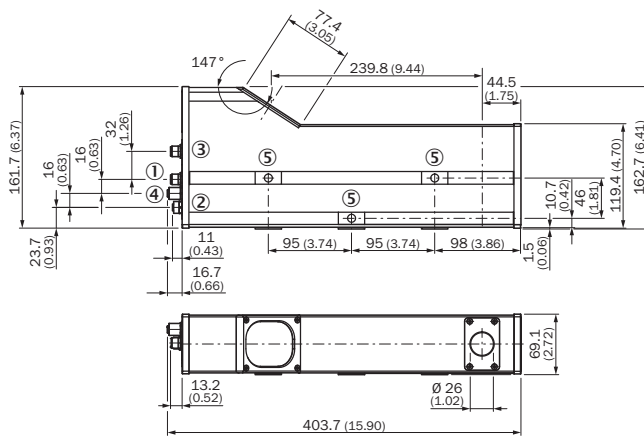

- ① Power I/O: M12, 8-pin, male
- ② Ethernet: M12, 4-pin, D-coded, female thread
- ③ Encoder: M12, 5-pin, male
- ④ M12, 8-pin female connector (RS-485)
- ⑤ Mounting holes M8 x 10

Field of view

Field of view overview

Typical field of view

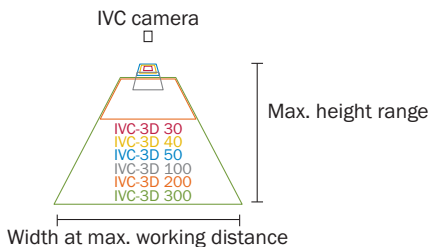

Field of view

IVC-3D 200

Typ. field of view in mm (inch)

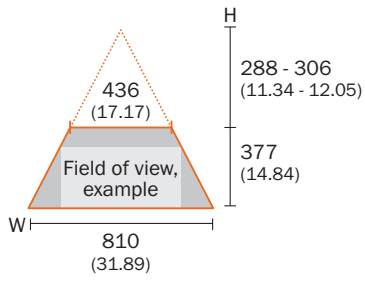

Connection type

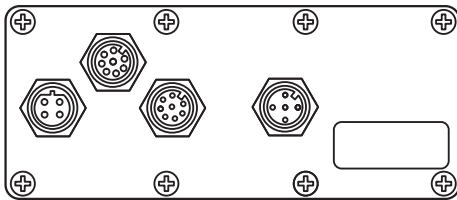

Connection diagram

Connection diagram, voltage I/O

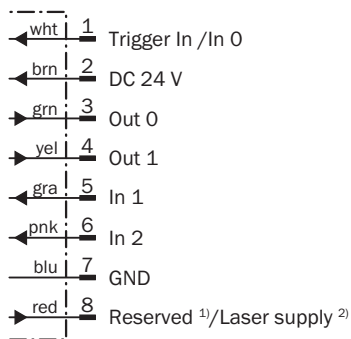

¹⁾ Do not connect for IVC-3D products with a type code as IVC-3Dxxx1x.

²⁾ Only in IVC-3D products with a type code as IVC-3Dxxx2x.

Ethernet connection diagram

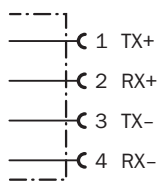

Connection diagram RS-485

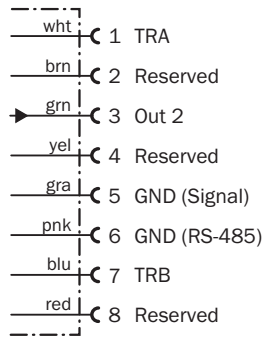



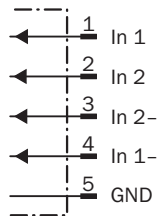

Encoder connection diagram



Recommended accessories

Other models and accessories → www.sick.com/IVC-3D

	Brief description	Type	Part no.
Plug connectors and cables			
	Head A: female connector, M12, 5-pin, straight, A-coded Head B: Flying leads Cable: Sensor/actuator cable, PVC, unshielded, 2 m	YF2A15-020VB5XLEAX	2096239
	Head A: female connector, M12, 8-pin, straight, A-coded Head B: Flying leads Cable: Sensor/actuator cable, PVC, shielded, 2 m	YF2A28-020VA6XLEAX	2096243
	Head A: male connector, M12, 8-pin, straight, A-coded Head B: Flying leads Cable: Sensor/actuator cable, PVC, shielded, 2 m	YM2A28-020VA6XLEAX	2096232
	Head A: female connector, M12, 4-pin, straight Head B: male connector, M12, 4-pin, straight Cable: Ethernet, unshielded Connection cable, extension cable 1:1, shielded, for TTK70 inspector	EtherNet/IP adapter	2044264
	Head A: male connector, M12, 4-pin, straight, D-coded Head B: male connector, RJ45, 8-pin, straight Cable: PROFINET, PUR, halogen-free, shielded, 3 m	SSL-2J04-G03MZ	6029630

SICK AT A GLANCE

SICK is one of the leading manufacturers of intelligent sensors and sensor solutions for industrial applications. A unique range of products and services creates the perfect basis for controlling processes securely and efficiently, protecting individuals from accidents and preventing damage to the environment.

We have extensive experience in a wide range of industries and understand their processes and requirements. With intelligent sensors, we can deliver exactly what our customers need. In application centers in Europe, Asia and North America, system solutions are tested and optimized in accordance with customer specifications. All this makes us a reliable supplier and development partner.

Comprehensive services complete our offering: SICK LifeTime Services provide support throughout the machine life cycle and ensure safety and productivity.

For us, that is “Sensor Intelligence.”

WORLDWIDE PRESENCE:

Contacts and other locations –www.sick.com