



# KT5W-2P1126D

KT5

CONTRAST SENSORS

**SICK**  
Sensor Intelligence.



### Ordering information

Type	Part no.
KT5W-2P1126D	1026579

Other models and accessories → [www.sick.com/KT5](http://www.sick.com/KT5)



### Detailed technical data

#### Features

<b>Dimensions (W x H x D)</b>	30.4 mm x 53 mm x 80 mm
<b>Sensing distance</b>	10 mm <sup>1)</sup>
<b>Housing design (light emission)</b>	Rectangular
<b>Light source</b>	LED, RGB <sup>2)</sup>
<b>Wave length</b>	470 nm, 525 nm, 640 nm
<b>Light emission</b>	Long and short side of housing, exchangeable
<b>Light spot size</b>	1.2 mm x 4.2 mm
<b>Light spot direction</b>	Vertical <sup>3)</sup>
<b>Adjustment</b>	Teach-in button
<b>Teach-in mode</b>	Static 2-point teach-in with manual fine adjustment

<sup>1)</sup> From front edge of lens.

<sup>2)</sup> Average service life: 100,000 h at T<sub>J</sub> = +25 °C.

<sup>3)</sup> In relation to long side of housing.

#### Mechanics/electronics

<b>Supply voltage</b>	10 V DC ... 30 V DC <sup>1)</sup>
<b>Ripple</b>	≤ 5 V <sub>pp</sub> <sup>2)</sup>
<b>Current consumption</b>	< 130 mA <sup>3)</sup>
<b>Switching frequency</b>	10 kHz <sup>4)</sup>
<b>Response time</b>	50 μs <sup>5)</sup>

<sup>1)</sup> Limit values when operated in short-circuit protected network: max. 8 A.

<sup>2)</sup> May not exceed or fall below U<sub>v</sub> tolerances.

<sup>3)</sup> Without load.

<sup>4)</sup> With light/dark ratio 1:1.

<sup>5)</sup> Signal transit time with resistive load.

<sup>6)</sup> Short-circuit-proof.

<sup>7)</sup> Reference voltage DC 50 V.

<b>Switching output</b>	PNP
<b>Switching output (voltage)</b>	PNP: HIGH = $V_S - \leq 2 \text{ V}$ / LOW approx. 0 V
<b>Output current <math>I_{\text{max}}</math></b>	100 mA <sup>6)</sup>
<b>Input, teach-in (ET)</b>	PNP Teach: $U = 10 \text{ V} \dots < U_V$ Run: $U < 2 \text{ V}$
<b>Retention time (ET)</b>	25 ms, non-volatile memory
<b>Time delay</b>	20 ms
<b>Connection type</b>	Male connector M12, 5-pin
<b>Protection class</b>	II <sup>7)</sup>
<b>Circuit protection</b>	$U_V$ connections, reverse polarity protected Output Q short-circuit protected Interference pulse suppression
<b>Enclosure rating</b>	IP67
<b>Weight</b>	400 g
<b>Housing material</b>	Metal, zinc diecast

1) Limit values when operated in short-circuit protected network: max. 8 A.

2) May not exceed or fall below  $U_V$  tolerances.

3) Without load.

4) With light/dark ratio 1:1.

5) Signal transit time with resistive load.

6) Short-circuit-proof.

7) Reference voltage DC 50 V.

## Ambient data

<b>Ambient operating temperature</b>	-10 °C ... +55 °C
<b>Ambient storage temperature</b>	-25 °C ... +75 °C
<b>Shock load</b>	According to IEC 60068

## Classifications

<b>ECl@ss 5.0</b>	27270906
<b>ECl@ss 5.1.4</b>	27270906
<b>ECl@ss 6.0</b>	27270906
<b>ECl@ss 6.2</b>	27270906
<b>ECl@ss 7.0</b>	27270906
<b>ECl@ss 8.0</b>	27270906
<b>ECl@ss 8.1</b>	27270906
<b>ECl@ss 9.0</b>	27270906
<b>ECl@ss 10.0</b>	27270906
<b>ECl@ss 11.0</b>	27270906
<b>ETIM 5.0</b>	EC001820
<b>ETIM 6.0</b>	EC001820
<b>ETIM 7.0</b>	EC001820
<b>UNSPSC 16.0901</b>	39121528

### Dimensional drawing (Dimensions in mm (inch))

KT5-2 Teach-in, KT5-2 Display

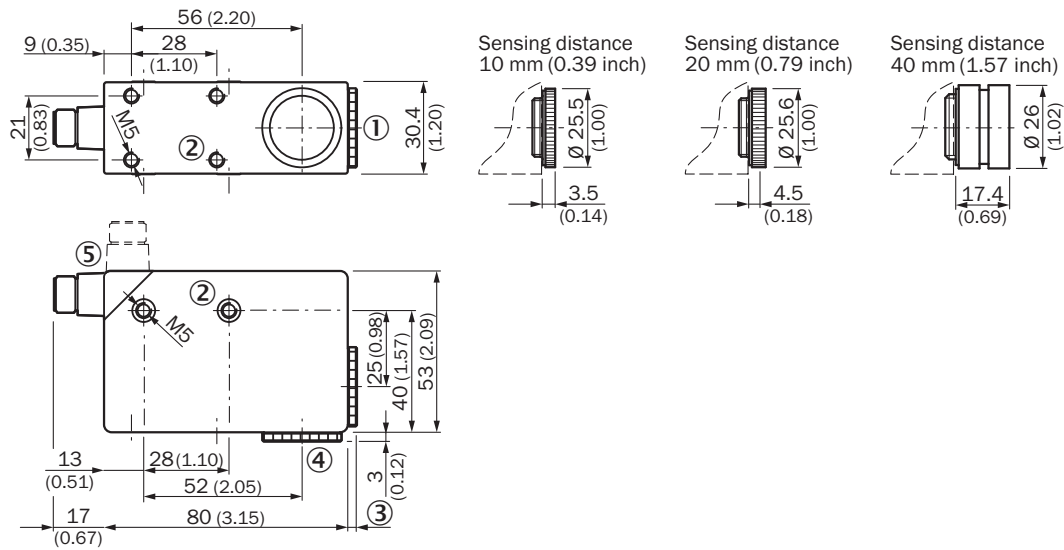

- ① Lens (light transmission), can be exchanged for pos. 4
- ② M5 threaded mounting hole, 5.5 mm deep
- ③ See dimensional drawings of lenses
- ④ Blind screw can be replaced by pos. 1
- ⑤ Connector M12 (rotatable up to 90°)

### Adjustments

KT5-2 Display

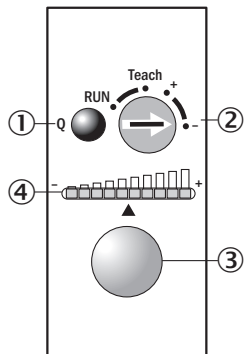

- ① Function signal indicator (yellow)
- ② Pre-selection switch
- ③ Teach-in button
- ④ Bar graph (green)

## Connection diagram

Cd-323



## Concept of operation

KT5-2 Display, Teach-in static

### 1. Position mark

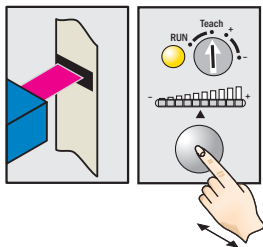

Turn rotary switch to "Teach" position. Press and hold teach-in button > 1 s. Red emitted light and yellow LED flash.

### 2. Position background

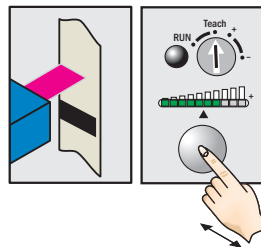

Press and hold teach-in button > 1 s. Yellow LED goes out. Optimum emitted light is selected.



Fine adjustment possible using the "+" / "-" buttons.

### Note

The bar display visualizes the detection reliability during teach-in. The more LEDs that illuminate, the better the teach-in:

- 1 LED illuminates = operation not reliable – contrast difference too low
- ≤ 4 LEDs illuminate = operation OK – sufficient contrast difference
- > 4 LEDs illuminate = reliable operation – high contrast difference

### Example

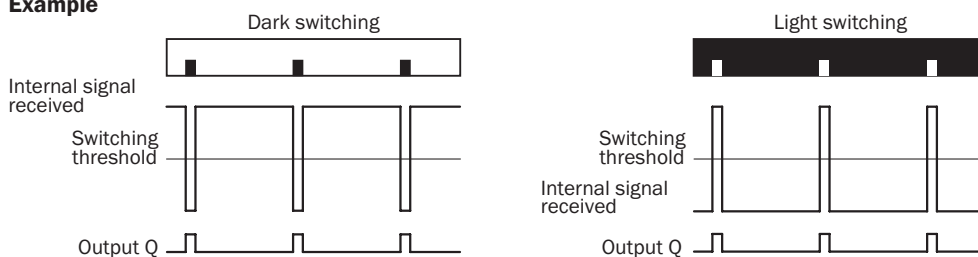

### Switching characteristics

The optimum emitted light is selected automatically.

Light/dark setting is defined using teach-in sequence.

The switching threshold is set in the center between the background and the mark.

Teach-in can also be performed using an external control signal.

### Sensing distance





Sensing distance



- ① Sensing distance 10 mm
- ② Sensing distance 20 mm
- ③ Sensing distance 40 mm

### Recommended accessories

Other models and accessories → [www.sick.com/KT5](http://www.sick.com/KT5)

	Brief description	Type	Part no.
<b>Universal bar clamp systems</b>			
	Plate G for universal clamp bracket, steel, zinc coated, Universal clamp (2022726), mounting hardware	BEF-KHS-G01	2022464
	Plate K for universal clamp bracket, steel, zinc coated, Universal clamp (2022726), mounting hardware	BEF-KHS-K01	2022718
	Universal clamp bracket for rod mounting, steel, zinc coated, without mounting hardware	BEF-KHS-KH1	2022726
	Mounting bar, straight, 200 mm, steel, steel, zinc coated, without mounting hardware	BEF-MS12G-A	4056054
	Mounting bar, straight, 300 mm, steel, steel, zinc coated, without mounting hardware	BEF-MS12G-B	4056055
	Mounting bar, L-shaped, 150 mm x 150 mm, steel, steel, zinc coated, without mounting hardware	BEF-MS12L-A	4056052
	Mounting bar, L-shaped, 250 x 250 mm, steel, steel, zinc coated, without mounting hardware	BEF-MS12L-B	4056053

	Brief description	Type	Part no.
<b>Plug connectors and cables</b>			
	Head A: female connector, M12, 5-pin, straight, A-coded Head B: Flying leads Cable: Sensor/actuator cable, PVC, unshielded, 2 m	YF2A15-020VB5XLEAX	2096239
	Head A: female connector, M12, 5-pin, straight, A-coded Head B: Flying leads Cable: Sensor/actuator cable, PVC, unshielded, 5 m	YF2A15-050VB5XLEAX	2096240
	Head A: female connector, M12, 5-pin, straight, A-coded Head B: Flying leads Cable: Sensor/actuator cable, PVC, unshielded, 10 m	YF2A15-100VB5XLEAX	2096241
	Head A: female connector, M12, 5-pin, angled, A-coded Head B: Flying leads Cable: Sensor/actuator cable, PVC, unshielded, 2 m	YG2A15-020VB5XLEAX	2096215
	Head A: female connector, M12, 5-pin, angled, A-coded Head B: Flying leads Cable: Sensor/actuator cable, PVC, unshielded, 5 m	YG2A15-050VB5XLEAX	2096216
	Head A: female connector, M12, 5-pin, angled, A-coded Head B: Flying leads Cable: Sensor/actuator cable, PVC, unshielded, 10 m	YG2A15-100VB5XLEAX	2096217
	Head A: female connector, M12, 5-pin, straight Cable: unshielded	DOS-1205-G	6009719
	Head A: female connector, M12, 5-pin, angled Head B: - Cable: unshielded	DOS-1205-W	6009720
<b>Lenses and accessories</b>			
		OBJ-210	2010945
		OBJ-211	1004936
		OBJ-212	1011506

## SICK AT A GLANCE

SICK is one of the leading manufacturers of intelligent sensors and sensor solutions for industrial applications. A unique range of products and services creates the perfect basis for controlling processes securely and efficiently, protecting individuals from accidents and preventing damage to the environment.

We have extensive experience in a wide range of industries and understand their processes and requirements. With intelligent sensors, we can deliver exactly what our customers need. In application centers in Europe, Asia and North America, system solutions are tested and optimized in accordance with customer specifications. All this makes us a reliable supplier and development partner.

Comprehensive services complete our offering: SICK LifeTime Services provide support throughout the machine life cycle and ensure safety and productivity.

For us, that is “Sensor Intelligence.”

## WORLDWIDE PRESENCE:

Contacts and other locations –[www.sick.com](http://www.sick.com)