



DFS60A-TEPK65536

DFS60

INCREMENTAL ENCODERS

SICK
Sensor Intelligence.



Illustration may differ



Ordering information

| Type | Part no. |
|------------------|----------|
| DFS60A-TEPK65536 | 1036964 |

Other models and accessories → www.sick.com/DFS60

Detailed technical data

Safety-related parameters

| | |
|--|--|
| MTTF_D (mean time to dangerous failure) | 300 years (EN ISO 13849-1) ¹⁾ |
|--|--|

¹⁾ This product is a standard product and does not constitute a safety component as defined in the Machinery Directive. Calculation based on nominal load of components, average ambient temperature 40 °C, frequency of use 8760 h/a. All electronic failures are considered hazardous. For more information, see document no. 8015532.

Performance

| | |
|---|-------------------------------------|
| Pulses per revolution | 65,536 ¹⁾ |
| Measuring step | 90°, electric/pulses per revolution |
| Measuring step deviation at binary number of lines | ± 0.0015° |
| Error limits | ± 0.03° |

¹⁾ See maximum revolution range.

Interfaces

| | |
|---------------------------------------|-----------------------------------|
| Communication interface | Incremental |
| Communication Interface detail | TTL / HTL |
| Factory setting | Factory setting: output level TTL |
| Number of signal channels | 6-channel |
| Programmable/configurable | ✓ |
| Initialization time | 32 ms, 30 ms ¹⁾ |
| Output frequency | ≤ 820 kHz |
| Load current | ≤ 30 mA |
| Power consumption | ≤ 0.7 W (without load) |

¹⁾ With mechanical zero pulse width.

Electronics

| | |
|------------------------|---|
| Connection type | Cable, 8-wire, universal, 1.5 m ¹⁾ |
|------------------------|---|

¹⁾ The universal cable connection is positioned so that it is possible to lay it without bends in a radial or axial direction.

²⁾ Programming TTL with ≥ 5.5 V: short-circuit opposite to another channel or GND permissible for maximum 30 s.

³⁾ Programming HTL or TTL with < 5.5 V: short-circuit opposite to another channel, US or GND permissible for maximum 30 s.

| | |
|--|---|
| Supply voltage | 4.5 ... 32 V |
| Reference signal, number | 1 |
| Reference signal, position | 90°, electric, logically gated with A and B |
| Reverse polarity protection | ✓ |
| Short-circuit protection of the outputs | ✓ ^{2) 3)} |

¹⁾ The universal cable connection is positioned so that it is possible to lay it without bends in a radial or axial direction.

²⁾ Programming TTL with ≥ 5.5 V: short-circuit opposite to another channel or GND permissible for maximum 30 s.

³⁾ Programming HTL or TTL with < 5.5 V: short-circuit opposite to another channel, US or GND permissible for maximum 30 s.

Mechanics

| | |
|---------------------------------------|---|
| Mechanical design | Through hollow shaft |
| Shaft diameter | 12 mm |
| Weight | + 0.2 kg |
| Shaft material | Stainless steel |
| Flange material | Aluminum |
| Housing material | Aluminum die cast |
| Start up torque | 0.8 Ncm (+20 °C) |
| Operating torque | 0.6 Ncm (+20 °C) |
| Permissible movement static | ± 0.3 mm (radial) ± 0.5 mm (axial) |
| Permissible movement dynamic | ± 0.05 mm (radial) ± 0.01 mm (axial) |
| Operating speed | $\leq 6,000$ min ⁻¹ ¹⁾ |
| Moment of inertia of the rotor | 40 gcm ² |
| Bearing lifetime | 3.6×10^{10} revolutions |
| Angular acceleration | $\leq 500,000$ rad/s ² |

¹⁾ Allow for self-heating of 3.3 K per 1,000 rpm when designing the operating temperature range.

Ambient data

| | |
|--------------------------------------|--|
| EMC | According to EN 61000-6-2 and EN 61000-6-3 |
| Enclosure rating | IP65, housing side, cable connection (IEC 60529) IP65, shaft side (IEC 60529) |
| Permissible relative humidity | 90 % (Condensation not permitted) |
| Operating temperature range | -40 °C ... +100 °C ¹⁾ -30 °C ... +100 °C ²⁾ |
| Storage temperature range | -40 °C ... +100 °C, without package |
| Resistance to shocks | 100 g, 6 ms (EN 60068-2-27) |
| Resistance to vibration | 30 g, 10 Hz ... 2,000 Hz (EN 60068-2-6) |

¹⁾ Stationary position of the cable.

²⁾ Flexible position of the cable.

Classifications

| | |
|---------------------|----------|
| ECLASS 5.0 | 27270501 |
| ECLASS 5.1.4 | 27270501 |
| ECLASS 6.0 | 27270590 |

| | |
|-----------------------|----------|
| ECLASS 6.2 | 27270590 |
| ECLASS 7.0 | 27270501 |
| ECLASS 8.0 | 27270501 |
| ECLASS 8.1 | 27270501 |
| ECLASS 9.0 | 27270501 |
| ECLASS 10.0 | 27270501 |
| ECLASS 11.0 | 27270501 |
| ECLASS 12.0 | 27270501 |
| ETIM 5.0 | EC001486 |
| ETIM 6.0 | EC001486 |
| ETIM 7.0 | EC001486 |
| ETIM 8.0 | EC001486 |
| UNSPSC 16.0901 | 41112113 |

Dimensional drawing (Dimensions in mm (inch))

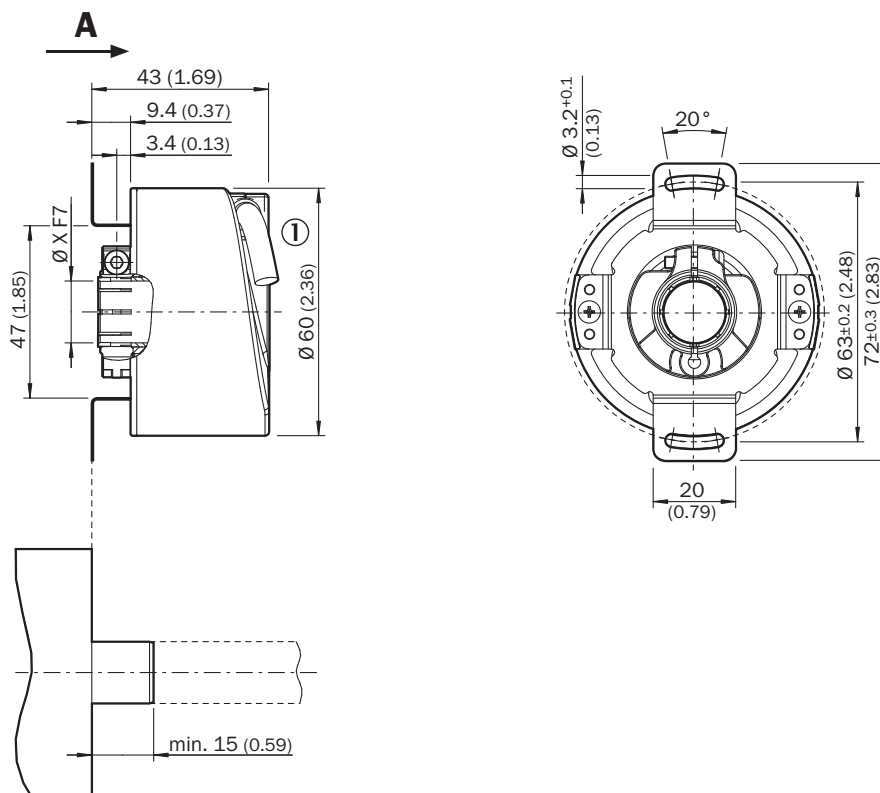

① Cable diameter = 5.6 mm +/- 0.2 mm bend radius = 30 mm

PIN assignment

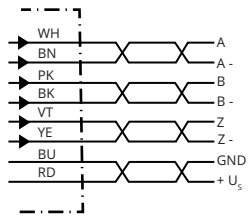

| PIN Male connector M12, 8-pin | PIN Male connector M23, 12-pin | Wire colors (cable connection) | TTL/HTL signal | Sin/Cos 1.0 V _{pp} | Explanation |
|----------------------------------|-----------------------------------|--------------------------------|---------------------|-----------------------------|---|
| 1 | 6 | Brown | \bar{A} | COS- | Signal wire |
| 2 | 5 | White | A | COS+ | Signal wire |
| 3 | 1 | Black | \bar{B} | SIN- | Signal wire |
| 4 | 8 | Pink | B | SIN+ | Signal wire |
| 5 | 4 | Yellow | \bar{Z} | \bar{Z} | Signal wire |
| 6 | 3 | Purple | Z | Z | Signal wire |
| 7 | 10 | Blue | GND | GND | Ground connection |
| 8 | 12 | Red | +U _S | +U _S | Supply voltage |
| - | 9 | - | N.c. | N.c. | Not assigned |
| - | 2 | - | N.c. | N.c. | Not assigned |
| - | 11 | - | N.c. | N.c. | Not assigned |
| - | 7 ¹⁾ | Orange | 0-SET ¹⁾ | N.c. | Set zero pulse ¹⁾ |
| Screen | Screen | Screen | Screen | Screen | Screen connected to housing on encoder side. Connected to ground on control side. |

¹⁾

For electrical interfaces only: M, U, V, W with 0-SET function on PIN 7 on M23 plug. The 0-SET input is used to set the zero pulse to the current shaft position. If the 0-SET input is applied to US for longer than 250 ms after it has previously been open or applied to GND for at least 1,000 ms, the current shaft position is assigned zero pulse signal "Z".

Diagrams

Mechanical zero pulse width 1° to 359° programmable. Width of the zero pulse in relation to a mechanical revolution of the shaft.



| Supply voltage | Output |
|----------------|----------------------|
| 4,5 V ... 32 V | TTL/HTL programmable |

Electrical zero pulse width can be configured to 90°, 180°, or 270°. Width of the zero pulse in relation to a pulse period.



Cw with view on the encoder shaft in direction "A", compare dimensional drawing.





| Supply voltage | Output |
|----------------|----------------------|
| 4,5 V ... 32 V | TTL/HTL programmable |

Maximum revolution range







Recommended accessories

Other models and accessories → www.sick.com/DFS60

| | Brief description | Type | Part no. |
|---|--|----------------|----------|
| Programming and configuration tools | | | |
|  | <ul style="list-style-type: none"> Accessory group: Programming and configuration tools Description: USB programming unit, for programmable SICK encoders AFS60, AFM60, DFS60, VFS60, DFV60 and wire draw encoders with programmable encoders | PGT-08-S | 1036616 |
|  | <ul style="list-style-type: none"> Accessory group: Programming and configuration tools Description: Programming unit display for programmable SICK DFS60, DFV60, AFS/AFM60, AHS/AHM36 encoders, and wire draw encoder with DFS60, AFS/AFM60 and AHS/AHM36. Compact dimensions, low weight, and intuitive operation. Items supplied: 1 x PGT-10-Pro stand-alone programming tool, 4 x alkaline type batteries, 1.5 V Mignon (AA) | PGT-10-Pro | 1072254 |
| Flanges | | | |
|  | <ul style="list-style-type: none"> Description: Standard stator coupling | BEF-DS00FX | 2056812 |
| Other mounting accessories | | | |
|  | <ul style="list-style-type: none"> Description: Bearing bracket for hollow shaft encoders, fastening screws included the Bearing Block is intended for very large radial and axial shaft loads. Particularly for application on: Belt pulleys, Chain pinions, Friction wheels. It is designed this way to enable fitting of encoder with blind hollow shaft with \varnothing 12 mm. Operating speed max. 6,000 rpm⁻¹, axial shaft load 100 N, radial shaft load 100 N, bearing service life 3.6×10^9 revolutions Items supplied: Fastening screws included | BEF-FA-B12-010 | 2042728 |
|  | <ul style="list-style-type: none"> Description: Clamping ring for metal hollow shaft¹⁾ Details: Metal | BEF-KR-M | 2064709 |

| | Brief description | Type | Part no. |
|---|--|------------------|----------|
| Others | | | |
|  | <ul style="list-style-type: none"> • Connection type head A: Male connector, M12, 8-pin, straight, A-coded • Signal type: Incremental • Cable: CAT5, CAT5e • Description: Incremental, shielded, Head A: male connector, M12, 8-pin, straight, A coded, shielded, for cable diameter 4 mm ... 8 mm Head B: - Operating temperature: -40 °C ... +85 °C • Connection systems: IDC quick connection • Permitted cross-section: 0.14 mm² ... 0.34 mm² | STE-1208-GA01 | 6044892 |
|  | <ul style="list-style-type: none"> • Connection type head A: Female connector, terminal box, 8-pin, straight • Connection type head B: Male connector, D-Sub, 9-pin, straight • Signal type: SSI + incremental • Cable: 0.5 m, 4-wire, PVC • Description: SSI + incremental, shielded, Programming cable for PGT-08-S and PGT-10-S programming tool • Note: Programming adapter cable for programming tool PGT-10-Pro and PGT-08-S | DSL-0D08-G0M5AC3 | 2061739 |
|  | <ul style="list-style-type: none"> • Connection type head A: Female connector, JST, 8-pin, straight • Connection type head B: Flying leads • Signal type: SSI, Incremental • Items supplied: JST including sealing • Cable: 3 m, 8-wire, PUR, halogen-free • Description: SSI, Incremental, shielded | DOL-0J08-G3M0AA6 | 2048591 |
|  | <ul style="list-style-type: none"> • Connection type head A: Female connector, JST, 8-pin, straight • Connection type head B: Flying leads • Signal type: SSI, Incremental • Items supplied: JST including sealing • Cable: 1.5 m, 8-wire, PUR, halogen-free • Description: SSI, Incremental, shielded | DOL-0J08-G1M5AA6 | 2048590 |
|  | <ul style="list-style-type: none"> • Connection type head A: Female connector, JST, 8-pin, straight • Connection type head B: Flying leads • Signal type: Incremental, SSI • Items supplied: JST including sealing • Cable: 0.5 m, 8-wire, PUR, halogen-free • Description: Incremental, SSI, shielded, Head A: female connector, JST, 8-pin, straight Head B: cable Cable: incremental, suitable for drag chain, PUR, halogen-free, shielded, 4 x 2 x 0.15 mm², Ø 5.6 mm | DOL-0J08-G0M5AA3 | 2046873 |
|  | <ul style="list-style-type: none"> • Connection type head A: Female connector, JST, 8-pin, straight • Connection type head B: Flying leads • Signal type: Incremental, SSI • Items supplied: JST including sealing • Cable: 5 m, 8-wire, PUR, halogen-free • Description: Incremental, SSI, shielded, Head A: female connector, JST, 8-pin, straight Head B: cable Cable: incremental, suitable for drag chain, PUR, halogen-free, shielded, 4 x 2 x 0.15 mm², Ø 5.6 mm | DOL-0J08-G05MAA3 | 2046876 |
|  | <ul style="list-style-type: none"> • Connection type head A: Female connector, JST, 8-pin, straight • Connection type head B: Flying leads • Signal type: Incremental, SSI • Items supplied: JST including sealing • Cable: 10 m, 8-wire, PUR, halogen-free • Description: Incremental, SSI, shielded, Head A: female connector, JST, 8-pin, straight Head B: cable Cable: incremental, suitable for drag chain, PUR, halogen-free, shielded, 4 x 2 x 0.15 mm², Ø 5.6 mm | DOL-0J08-G10MAA3 | 2046877 |
|  | <ul style="list-style-type: none"> • Connection type head A: Male connector, M23, 12-pin, straight, A-coded • Signal type: HIPERFACE[®], SSI, Incremental • Description: HIPERFACE[®], SSI, Incremental, shielded, M23 female connector with central fixing (for cabinet bushing) • Connection systems: Solder connection | STE-2312-GX | 6028548 |

| | Brief description | Type | Part no. |
|---|---|------------------|----------|
|  | <ul style="list-style-type: none"> • Connection type head A: Male connector, M23, 12-pin, straight, A-coded • Signal type: HIPERFACE[®], SSI, Incremental • Description: HIPERFACE[®], SSI, Incremental, shielded, Head A: male connector, M23, 12-pin, straight, for cable diameter 5.5 mm ... 10.5 mm Head B: - Operating temperature: -40 °C ... +125 °C • Connection systems: Solder connection | STE-2312-G01 | 2077273 |
|  | <ul style="list-style-type: none"> • Connection type head A: Female connector, JST, 8-pin, straight • Connection type head B: Male connector, M23, 12-pin, straight • Signal type: Incremental • Cable: 0.35 m, 8-wire, PUR, halogen-free • Description: Incremental, shielded, Head A: female connector, JST, 8-pin, straight Head B: male connector, M23, 12-pin, straight Cable: suitable for drag chain, PUR, halogen-free, shielded, 4 x 2 x 0.15 mm², Ø 5.6 mm | STL-2312-GM35AA3 | 2061621 |
|  | <ul style="list-style-type: none"> • Connection type head A: Female connector, JST, 8-pin, straight • Connection type head B: Male connector, M23, 12-pin, straight • Signal type: Incremental • Cable: 1 m, 8-wire, PUR, halogen-free • Description: Incremental, shielded, Head A: female connector, JST, 8-pin, straight Head B: male connector, M23, 12-pin, straight Cable: suitable for drag chain, PUR, halogen-free, shielded, 4 x 2 x 0.15 mm², Ø 5.6 mm | STL-2312-G01MAA3 | 2061622 |
|  | <ul style="list-style-type: none"> • Connection type head A: Female connector, JST, 8-pin, straight • Connection type head B: Male connector, M23, 12-pin, straight • Signal type: Incremental • Cable: 2 m, 8-wire, PUR, halogen-free • Description: Incremental, shielded, Head A: female connector, JST, 8-pin, straight Head B: male connector, M23, 12-pin, straight Cable: suitable for drag chain, PUR, halogen-free, shielded, 4 x 2 x 0.15 mm², Ø 5.6 mm | STL-2312-G02MAA3 | 2061504 |

SICK AT A GLANCE

SICK is one of the leading manufacturers of intelligent sensors and sensor solutions for industrial applications. A unique range of products and services creates the perfect basis for controlling processes securely and efficiently, protecting individuals from accidents and preventing damage to the environment.

We have extensive experience in a wide range of industries and understand their processes and requirements. With intelligent sensors, we can deliver exactly what our customers need. In application centers in Europe, Asia and North America, system solutions are tested and optimized in accordance with customer specifications. All this makes us a reliable supplier and development partner.

Comprehensive services complete our offering: SICK LifeTime Services provide support throughout the machine life cycle and ensure safety and productivity.

For us, that is “Sensor Intelligence.”

WORLDWIDE PRESENCE:

Contacts and other locations –www.sick.com