



LFBV330-XAGBVXVT0500

LFBV300

LEVEL SENSORS

SICK
Sensor Intelligence.



Illustration may differ



Ordering information

Type	Part no.
LFV330-XAGBVXVT0500	6042881

Other models and accessories → www.sick.com/LFV300

Detailed technical data

Features

Medium	Fluids
Measurement	Switch
Probe length	500 mm
Process pressure	-1 bar ... 64 bar
Process temperature	-50 °C ... +150 °C
Fill material density	0.5 g/cm ³ ... 2.5 g/cm ³
WHG approval	✓
Authorizations	WHG approval

Performance

Accuracy of sensor element	± 2 mm
Reproducibility	≤ 1 mm
Viscosity	0.1 mPas ... 10,000 mPas
Response time	500 ms
MTBF	9,73*10 ⁶ h

Electronics

Residual ripple	≤ 5 V _{pp}
Power consumption	< 10 mA
Initialization time	< 2 s
VDE protection class 2	✓
Connection type	M20 x 1.5
Output signal	1 x PNP/NPN
Supply voltage	Volt-free transistor output PNP/ NPN: 10 V DC ... 55 V DC
Hysteresis	2 mm
Output current	< 300 mA
Inductive load	≤ 1 H
Capacitive load	100 nF

Enclosure rating	IP66 / IP67
Temperature drift	0,03 mm/K

Mechanics

Wetted parts	Stainless steel 316L (optional Ra ≤ 0.8 µm)
Process connection	G ¾ A PN 64 / 1.4404
Housing material	Stainless steel (investment casting) 316L
Sensor material	Stainless steel 1.4404

Ambient data

Ambient operating temperature	-40 °C ... +70 °C
Ambient temperature, storage	-40 °C ... +80 °C

Classifications

ECLASS 5.0	27273202
ECLASS 5.1.4	27273202
ECLASS 6.0	27273202
ECLASS 6.2	27273202
ECLASS 7.0	27273202
ECLASS 8.0	27273202
ECLASS 8.1	27273202
ECLASS 9.0	27273202
ECLASS 10.0	27273202
ECLASS 11.0	27273202
ECLASS 12.0	27273106
ETIM 5.0	EC002654
ETIM 6.0	EC002654
ETIM 7.0	EC002654
ETIM 8.0	EC002654
UNSPSC 16.0901	41111938

Type code

LFV330 type code

Certification	
XX	Without approval
XA	WHG approval
CA	ATEX II 1G, 1/2G, 2G Ex ia IIC T6 Ga, Ga/Gb, Gb +WHG
DA	ATEX II 1/2G Ex db IIC T6...T2 Ga/Gb +WHG
Process connection/Material (see below)	
Middle section / Process temperature	
X	without / -50 °C ... +150 °C
T	with / -50 °C ... +250 °C
Housing / Cable screw connection	
P	Plastics IP 66, IP 67 / M20 x 1,5
N	Plastics IP 66, IP 67 / ½" NPT
M	Aluminium IP 66, IP 67 / M20 x 1,5
U	Aluminium IP 66, IP 67 / ½" NPT
V	Stainless steel (precision casting) 316L IP66, IP67 / M20 x 1,5

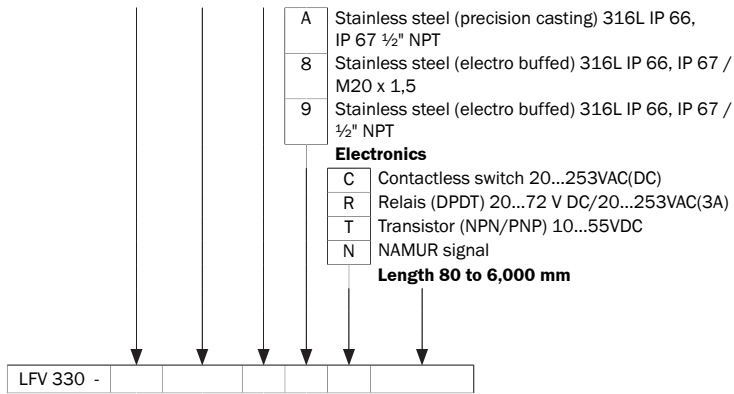

Not all variations of the type code can be combined! Not all available variations are shown.

Process connection/Material

GBV	Thread G 3/4 A PN 64 / 316L
GBP	Thread G 3/4 A PN 64 / 316L Ra<0,8µm
NBV	Thread 3/4" NPT PN 64 / 316L
NBP	Thread 3/4" NPT PN 64 / 316L Ra<0,8µm
GAV	Thread G 1 A PN 64 / 316L
GAP	Thread G 1 A PN 64 / 316L Ra<0,8µm
NAV	Thread 1" NPT PN 64 / 316L
NAP	Thread 1" NPT PN 64 / 316L Ra<0,8µm
GCV	Thread G 1 1/2 A PN 64 / 316L
NCV	Thread 1 1/2" NPT PN 64 / 316L
TAP	Varivent N50-40 / 316L Ra<0,8µm ZB3052
TNP	Varivent N25-100 / 316L Ra<0,8µm ZB3052
CCP	Tri-Clamp 1" PN 16 / 316L Ra<0,8µm
CBP	Tri-Clamp 1 1/2" PN 16 / 316L Ra<0,8µm
CAP	Tri-Clamp 2" PN 16 / 316L Ra<0,8µm
CDP	Tri-Clamp 2 1/2" PN 10 / 316L Ra<0,8µm
CEP	Tri-Clamp 3" PN 10 / 316L Ra<0,8µm

PLV	Flange DN 125, PN 40 Form N, DIN 2501 / 316L
FMV	Flange DN 150, PN 16 Form C, DIN 2501 / 316L
MMV	Flange DN 150, PN 16 Form D, DIN 2501 / 316L
FVV	Flange DN 150, PN 40 Form C, DIN 2501 / 316L
OVV	Flange DN 150, PN 40 Form F, DIN 2501 / 316L
PVV	Flange DN 150, PN 40 Form N, DIN 2501 / 316L
FQV	Flange DN 200, PN 16 Form C, DIN 2501 / 316L
F5V	Flange DN 250, PN 10 Form C, DIN 2501 / 316L
UCV	Flange DN 40, PN 40 V13, DIN 2501 / 316L
FEV	Flange DN 50, PN 40 Form C, DIN 2501 / 316L
RCP	Fitting DN 25, PN 40, DIN 11851 / 316L Ra<0,8µm
REP	Fitting DN 32, PN 40, DIN 11851 / 316L Ra<0,8µm
RAP	Fitting DN 40, PN 40, DIN 11851 / 316L Ra<0,8µm
RFP	Fitting DN 40, PN 40, DIN 11864-1A / 316L Ra<0,8µm ZB3052
RBP	Fitting DN 50, PN 25, DIN 11851 / 316L Ra<0,8µm
RDP	Fitting DN 50, PN 25, DIN 11864-1A / 316L Ra<0,8µm ZB3052

Dimensional drawing (Dimensions in mm (inch))

LFV330



- ① Thread
- ② Tri-Clamp
- ③ DN 25 cone
- ④ Bolting D 40
- ⑤ Flange
- ⑥ Gas-tight leadthrough
- ⑦ Temperature adapter

Marking on the welded flange



Connection diagram

Transistor - electronic module



- ① Signal lamp (LED)
- ② DIL switch for mode adjustment
- ③ DIL-switch for sensitivity adjustment

PNP action



NPN action



Instruction for installation

Inflowing medium

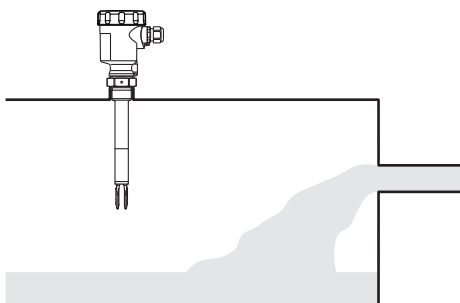

Characteristic curve





Influence of the process temperature on the switching point



- ① Shifting of the switching point in mm (in)
- ② Process temperature in °C (°F)
- ③ Switching point at reference conditions (notch)
- ④ Tuning fork

Recommended accessories

Other models and accessories → www.sick.com/LFV300

	Brief description	Type	Part no.
Electronic modules			
	Transistor (PNP/NPN): 10 V DC ... 55 V DC	ECD-RE-LFVP-NP-0001	6038672
Flanges			
	Welded flange/welded connector, DIN11851-1, DN25 / PN40, Stainless steel 1.4404	BEF-FL-851D25-LFV2	5321527
	Welded flange/welded connector, process connection G 1, Stainless steel 1.4404	BEF-FL-GEWG10-LFV2	4054605
	Welded flange/welded connector, G 3/4 process connection, Stainless steel 1.4404	BEF-FL-GEWG34-LFV2	4054604
	Welded flange/welded connector, process connection Tri-Clamp 1", Stainless steel 1.4404	BEF-FL-TCLI10-LFV2	5321678
	Welded flange/welded connector, process connection Tri-Clamp 2", Stainless steel 1.4404	BEF-FL-TCLI20-LFV2	5321679
Mounting brackets and plates			
	BEF-MU-316G10-ALFV	BEF-MU-316G10-ALFV	5322463

SICK AT A GLANCE

SICK is one of the leading manufacturers of intelligent sensors and sensor solutions for industrial applications. A unique range of products and services creates the perfect basis for controlling processes securely and efficiently, protecting individuals from accidents and preventing damage to the environment.

We have extensive experience in a wide range of industries and understand their processes and requirements. With intelligent sensors, we can deliver exactly what our customers need. In application centers in Europe, Asia and North America, system solutions are tested and optimized in accordance with customer specifications. All this makes us a reliable supplier and development partner.

Comprehensive services complete our offering: SICK LifeTime Services provide support throughout the machine life cycle and ensure safety and productivity.

For us, that is “Sensor Intelligence.”

WORLDWIDE PRESENCE:

Contacts and other locations –www.sick.com