



WSE27-3P2410

W27

COMPACT PHOTOELECTRIC SENSORS

SICK
Sensor Intelligence.



Illustration may differ

Ordering information

Type	Part no.
WSE27-3P2410	1048199

Other models and accessories → www.sick.com/W27



Detailed technical data

Features

Functional principle	Through-beam photoelectric sensor
Dimensions (W x H x D)	24.6 mm x 80.6 mm x 54 mm
Housing design (light emission)	Rectangular
Sensing range max.	0 m ... 35 m
Sensing range	0 m ... 25 m
Focus	Approx. 6°
Type of light	Infrared light
Light source	LED ¹⁾
Light spot size (distance)	Ø 3.7 m (25 m)
Angle of dispersion	Approx. 6°
Wave length	880 nm
Adjustment	None

¹⁾ Average service life: 100,000 h at T_U = +25 °C.

Mechanics/electronics

Supply voltage U_B	10 V DC ... 30 V DC ¹⁾
-------------------------------------	-----------------------------------

- ¹⁾ Limit values when operated in short-circuit protected network: max. 8 A.
- ²⁾ May not exceed or fall below U_V tolerances.
- ³⁾ Without load.
- ⁴⁾ Signal transit time with resistive load.
- ⁵⁾ With light/dark ratio 1:1.
- ⁶⁾ A = V_S connections reverse-polarity protected.
- ⁷⁾ B = inputs and output reverse-polarity protected.
- ⁸⁾ C = interference suppression.
- ⁹⁾ Reference voltage: 50 V DC.

Ripple	< 5 V _{pp} ²⁾
Power consumption, sender	45 mA ³⁾
Power consumption, receiver	20 mA ³⁾
Switching output	PNP
Output function	Complementary
Switching mode	Light/dark switching
Signal voltage PNP HIGH/LOW	Approx. V _S – 2.5 V / 0 V
Output current I_{max.}	≤ 100 mA
Response time	≤ 500 μs ⁴⁾
Switching frequency	1,000 Hz ⁵⁾
Angle of reception	Approx. 3°
Connection type	Male connector M12, 4-pin
Circuit protection	A ⁶⁾ B ⁷⁾ C ⁸⁾
Protection class	II ⁹⁾
Weight	200 g
Housing material	Plastic, ABS
Optics material	Plastic, PMMA
Enclosure rating	IP69K
Test input sender off	TE to 0 V
Ambient operating temperature	–40 °C ... +60 °C
Ambient temperature, storage	–40 °C ... +75 °C
UL File No.	NRKH.E181493 & NRKH7.E181493
Part number of individual components	2051801 WE27-3P2410 2051802 WS27-3D2410

1) Limit values when operated in short-circuit protected network: max. 8 A.

2) May not exceed or fall below U_v tolerances.

3) Without load.

4) Signal transit time with resistive load.

5) With light/dark ratio 1:1.

6) A = V_S connections reverse-polarity protected.

7) B = inputs and output reverse-polarity protected.

8) C = interference suppression.

9) Reference voltage: 50 V DC.

Safety-related parameters

MTTF_D	996 years
DC_{avg}	0 %

Classifications

ECLASS 5.0	27270901
ECLASS 5.1.4	27270901
ECLASS 6.0	27270901
ECLASS 6.2	27270901

ECLASS 7.0	27270901
ECLASS 8.0	27270901
ECLASS 8.1	27270901
ECLASS 9.0	27270901
ECLASS 10.0	27270901
ECLASS 11.0	27270901
ECLASS 12.0	27270901
ETIM 5.0	EC002716
ETIM 6.0	EC002716
ETIM 7.0	EC002716
ETIM 8.0	EC002716
UNSPSC 16.0901	39121528

Connection type

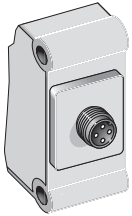

Connection diagram

Cd-072

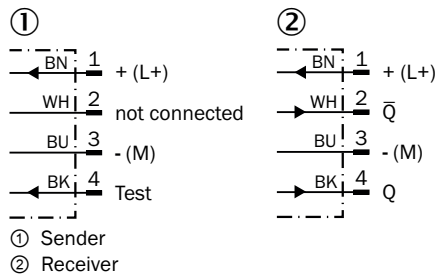

Characteristic curve

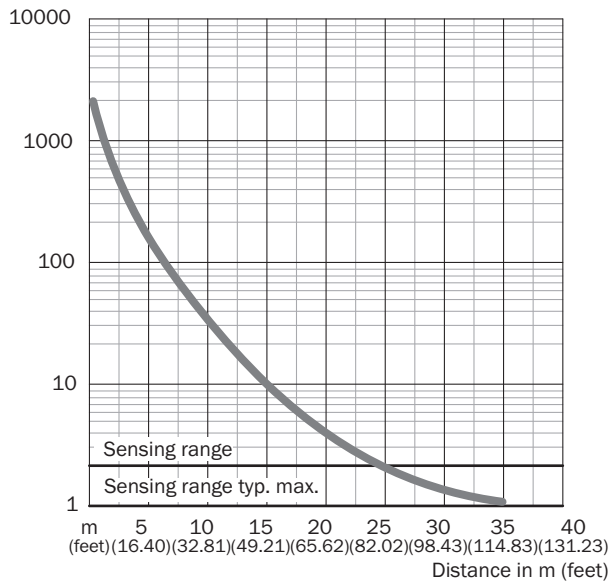

Sensing range diagram

WSE27-3

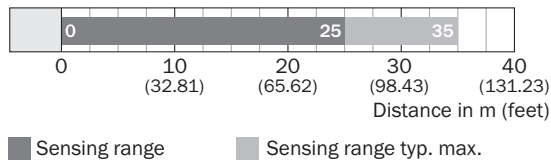

Dimensional drawing (Dimensions in mm (inch))

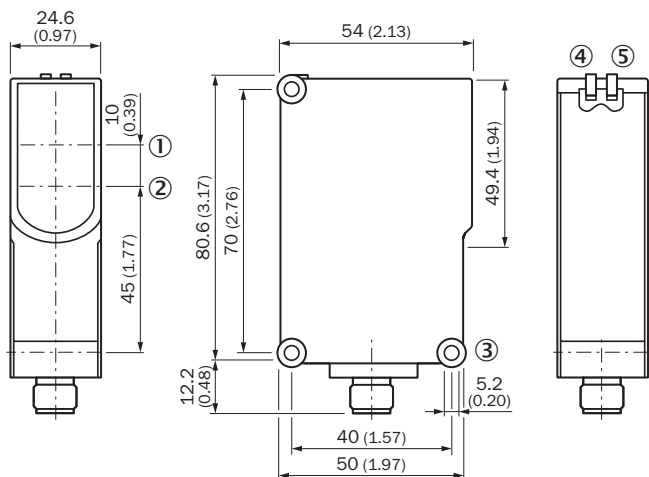

WL27-3, WSE27-3



- ① Optical axis, sender
- ② Optical axis, receiver
- ③ Mounting hole \varnothing 5.2 mm
- ④ LED indicator green: Supply voltage active
- ⑤ LED indicator yellow: Status of received light beam

Recommended accessories

Other models and accessories → www.sick.com/W27

	Brief description	Type	Part no.
Device protection (mechanical)			
	Protective housing for W26, W27-3 and mounting rods with diameter 12 mm ... 20 mm, Zinc plated steel (protective housing), Zinc die cast (clamping bracket), Universal clamp BEF-KHS-KH1 (2022726), mounting hardware	BEF-SG-W27	2039601
Others			
	<ul style="list-style-type: none"> • Connection type head A: Female connector, M12, 4-pin, straight, A-coded • Connection type head B: Flying leads • Signal type: Sensor/actuator cable • Cable: 5 m, 4-wire, PVC • Description: Sensor/actuator cable, unshielded • Application: Zones with chemicals 	YF2A14-050VB3XLEAX	2096235
	<ul style="list-style-type: none"> • Connection type head A: Male connector, M12, 4-pin, straight, A-coded • Description: Unshielded • Connection systems: Screw-type terminals • Permitted cross-section: \leq 0.75 mm² 	STE-1204-G	6009932

SICK AT A GLANCE

SICK is one of the leading manufacturers of intelligent sensors and sensor solutions for industrial applications. A unique range of products and services creates the perfect basis for controlling processes securely and efficiently, protecting individuals from accidents and preventing damage to the environment.

We have extensive experience in a wide range of industries and understand their processes and requirements. With intelligent sensors, we can deliver exactly what our customers need. In application centers in Europe, Asia and North America, system solutions are tested and optimized in accordance with customer specifications. All this makes us a reliable supplier and development partner.

Comprehensive services complete our offering: SICK LifeTime Services provide support throughout the machine life cycle and ensure safety and productivity.

For us, that is “Sensor Intelligence.”

WORLDWIDE PRESENCE:

Contacts and other locations –www.sick.com