



Illustration may differ

Ordering information

Type	Part no.
TMM88B-PLC090	1073797

Other models and accessories → www.sick.com/TMS_TMM88



Detailed technical data

Performance

Number of axis	2
Measuring range	± 90°
Resolution	0.01°
Static measurement accuracy	≤ ± 60°, typ. ± 0.1°, max. ± 0.2° ≤ ± 80°, typ. ± 0.2°, max. ± 0.4°
Compensated cross-sensitivity (2-dimensional)	Typ. ± 0.1°, max. ± 0.2°
Temperature coefficient (zero point)	Typ. ± 0.01°/K ¹⁾
Limit frequency	0.1 Hz ... 25 Hz, 8. range (with digital filter)
Sampling rate	80 Hz

¹⁾ Referring to the temperature of 25 °C.

Interfaces

Communication interface	Analog / Voltage
Voltage output	0 V ... 10 V
Parameterising data	Measuring range Zeraset Limit frequency Preset value Inverting of counting direction Axis assignment Free adjustable outbound
Programmable/configurable	Over PGT-12-Pro
Initialization time	270 ms

Electrical data

Connection type	Male connector, M12, 5-pin
Supply voltage	17 V DC ... 35 V DC
Current consumption	< 35 mA @ 24 V
Reverse polarity protection	✓
Short-circuit protection of the outputs	✓
MTTFd: mean time to dangerous failure	348 years (EN ISO 13849-1) ¹⁾

¹⁾ This product is a standard product and does not constitute a safety component as defined in the Machinery Directive. Calculation based on nominal load of components, average ambient temperature 40°C, frequency of use 8760 h/a. All electronic failures are considered hazardous. For more information, see document no. 8015532.

Mechanical data

Dimensions	66 mm x 90 mm x 31 mm
Weight	200 g
Housing material	Plastic (PBT)

Ambient data

EMC	EN 61326-1, EN ISO 14982, EN ISO 13309
Enclosure rating	IP65 IP67
Operating temperature range	-40 °C ... +80 °C
Storage temperature range	-40 °C ... +85 °C
Resistance to shocks	100 g, 6 ms (according to EN 60068-2-27)
Resistance to vibration	10 g, 10 Hz ... 2,000 Hz (EN 60068-2-6)

Classifications

eCl@ss 5.0	27270790
eCl@ss 5.1.4	27270790
eCl@ss 6.0	27270790
eCl@ss 6.2	27270790
eCl@ss 7.0	27270790
eCl@ss 8.0	27270790
eCl@ss 8.1	27270790
eCl@ss 9.0	27270790
eCl@ss 10.0	27271101
eCl@ss 11.0	27271101
eCl@ss 12.0	27271101
ETIM 5.0	EC001852
ETIM 6.0	EC001852
ETIM 7.0	EC001852
ETIM 8.0	EC001852
UNSPSC 16.0901	41111613

Dimensional drawing (Dimensions in mm (inch))

TMx88x-PxC

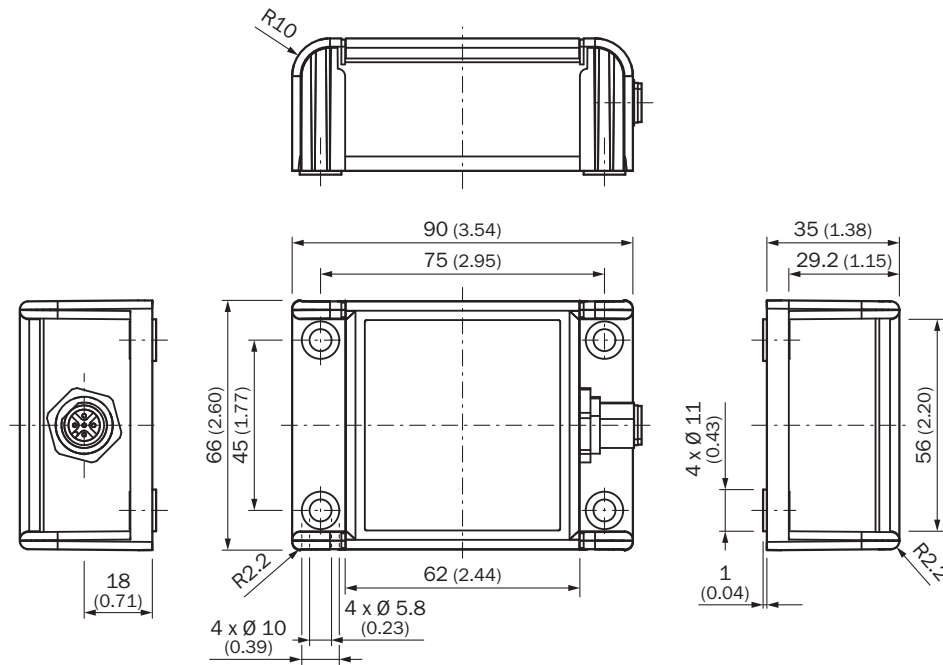



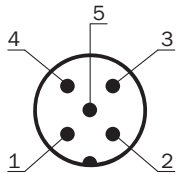



PIN assignment



PIN Male connector M12, 5-pin	Signal	Function
1	VDC	Supply voltage
2	B-OUT	Sensor output B (default: Y)
3	GND	0V (GND)
4	A-OUT	Sensor output A (default: X)
5	TEACH	Input for Zero point setting

Recommended accessories

Other models and accessories → www.sick.com/TMS_TMM88

	Brief description	Type	Part no.
Programming and configuration tools			
	Hand-held programming device for the programmable SICK AHS/AHM36 CANopen encoders, TMS/TMM61 CANopen inclination sensors, TMS/TMM88 CANopen, TMS/TMM88 Analog, and wire draw encoders with AHS/AHM36 CANopen. Compact dimensions, low weight, and intuitive operation.	PGT-12-Pro	1076313
Plug connectors and cables			
	Head A: female connector, M12, 5-pin, angled, A-coded Head B: Flying leads Cable: Sensor/actuator cable, Power, PUR, halogen-free, shielded, 1.5 m	DOL-1205-W1M5ACSCO	6049455
	Head A: female connector, M12, 5-pin, straight, A-coded Head B: Flying leads Cable: Sensor/actuator cable, PUR, halogen-free, shielded, 1.5 m	YF2A25-015UB6XLEAX	2095833
	Head A: female connector, M12, 5-pin, straight, A-coded Head B: Flying leads Cable: Sensor/actuator cable, PUR, halogen-free, shielded, 3 m	YF2A25-030UB6XLEAX	2095834
	Head A: female connector, M12, 5-pin, angled, A-coded Head B: Flying leads Cable: Sensor/actuator cable, PUR, halogen-free, shielded, 3 m	YG2A25-030UB6XLEAX	2095791
	Head A: female connector, M12, 5-pin, angled, A-coded Head B: Flying leads Cable: Sensor/actuator cable, PUR, halogen-free, shielded, 5 m	YG2A25-050UB6XLEAX	2095792
	Head A: female connector, M12, 5-pin, angled, A-coded Head B: Flying leads Cable: Sensor/actuator cable, PUR, halogen-free, shielded, 10 m	YG2A25-100UB6XLEAX	2095793
	Head A: female connector, M12, 5-pin, straight Cable: unshielded	DOS-1205-G	6009719
	Head A: male connector, M12, 5-pin, straight Cable: unshielded For field bus technology	STE-1205-G	6022083

SICK AT A GLANCE

SICK is one of the leading manufacturers of intelligent sensors and sensor solutions for industrial applications. A unique range of products and services creates the perfect basis for controlling processes securely and efficiently, protecting individuals from accidents and preventing damage to the environment.

We have extensive experience in a wide range of industries and understand their processes and requirements. With intelligent sensors, we can deliver exactly what our customers need. In application centers in Europe, Asia and North America, system solutions are tested and optimized in accordance with customer specifications. All this makes us a reliable supplier and development partner.

Comprehensive services complete our offering: SICK LifeTime Services provide support throughout the machine life cycle and ensure safety and productivity.

For us, that is “Sensor Intelligence.”

WORLDWIDE PRESENCE:

Contacts and other locations –www.sick.com