



# SLG25S-020SAKB1K01

FlexChain

SWITCHING AUTOMATION LIGHT GRIDS

**SICK**  
Sensor Intelligence.



Illustration may differ

### Ordering information

Type	Part no.
SLG25S-020SAKB1K01	1107856

Only in conjunction with FlexChain host

[1091608](https://www.sick.com/1091608) | FC1A-AZ2A1A: Standard I/O

[1091609](https://www.sick.com/1091609) | FC1A-BZ2A1A: Advanced I/O

[1091610](https://www.sick.com/1091610) | FC1A-CZ2A1A: RS-485

[1091611](https://www.sick.com/1091611) | FC1A-DZ2A1A: CANopen

Other models and accessories → [www.sick.com/FlexChain](http://www.sick.com/FlexChain)



### Detailed technical data

#### Features

<b>Device version</b>	FlexChain Guest
<b>Sensor principle</b>	Sender/receiver Light grid system
<b>Minimum detectable object (MDO)</b>	30 mm
<b>Beam separation</b>	25 mm
<b>Optical light exit</b>	Slim
<b>Number of beams</b>	8
<b>Detection height</b>	200 mm

#### Mechanics/electronics

<b>Light source</b>	Infrared light
<b>Wave length</b>	850 nm
<b>Supply voltage <math>V_s</math></b>	Via FlexChain (host)
<b>Output load, capacitive</b>	100 nF
<b>Output load, Inductive</b>	1 H
<b>Initialization time</b>	1 s
<b>Dimensions (W x H x D)</b>	24.1 mm x 199.2 mm x 11.8 mm
<b>Connection type</b>	Cable with M8 male connector, 4-pin, Cable with female connector, M8, 4-pin, 1.5 m
<b>Indication</b>	LED
<b>Synchronization</b>	Via FlexChain (host)
<b>Enclosure rating</b>	IP65, IP67 1)
<b>Circuit protection</b>	$U_V$ connections, reverse polarity protected

<sup>1)</sup> Operating in outdoor condition only with a external protection housing.

	Interference pulse suppression Outputs overcurrent and short-circuit protected
<b>Protection class</b>	III
<b>Weight</b>	206 g
<b>Front screen</b>	PMMA

<sup>1)</sup> Operating in outdoor condition only with a external protection housing.

## Performance

<b>Maximum range</b>	6 m
<b>Minimum range</b>	≥ 0 m
<b>Operating range</b>	4 m
<b>Scanning time</b>	0.6 ms

## Ambient data

<b>Shock resistance</b>	10 g, 16 ms, DIN EN 60068-2-27
<b>Vibration resistance</b>	10-150 Hz 0.5 mm, IEC 60068-2-6
<b>EMC</b>	EN 61000-6-2, EN 61000-6-4
<b>Ambient light immunity</b>	Indirect: 50,000 lx <sup>1)</sup>
<b>Ambient operating temperature</b>	-25 °C ... +55 °C
<b>Ambient temperature, storage</b>	-25 °C ... +70 °C

<sup>1)</sup> Sunlight.

## Classifications

<b>ECLASS 5.0</b>	27270910
<b>ECLASS 5.1.4</b>	27270910
<b>ECLASS 6.0</b>	27270910
<b>ECLASS 6.2</b>	27270910
<b>ECLASS 7.0</b>	27270910
<b>ECLASS 8.0</b>	27270910
<b>ECLASS 8.1</b>	27270910
<b>ECLASS 9.0</b>	27270910
<b>ECLASS 10.0</b>	27270910
<b>ECLASS 11.0</b>	27270910
<b>ECLASS 12.0</b>	27270910
<b>ETIM 5.0</b>	EC002549
<b>ETIM 6.0</b>	EC002549
<b>ETIM 7.0</b>	EC002549
<b>ETIM 8.0</b>	EC002549
<b>UNSPSC 16.0901</b>	39121528

### Dimensional drawing (Dimensions in mm (inch))

SLGxxx-xxxSxxxxxxx

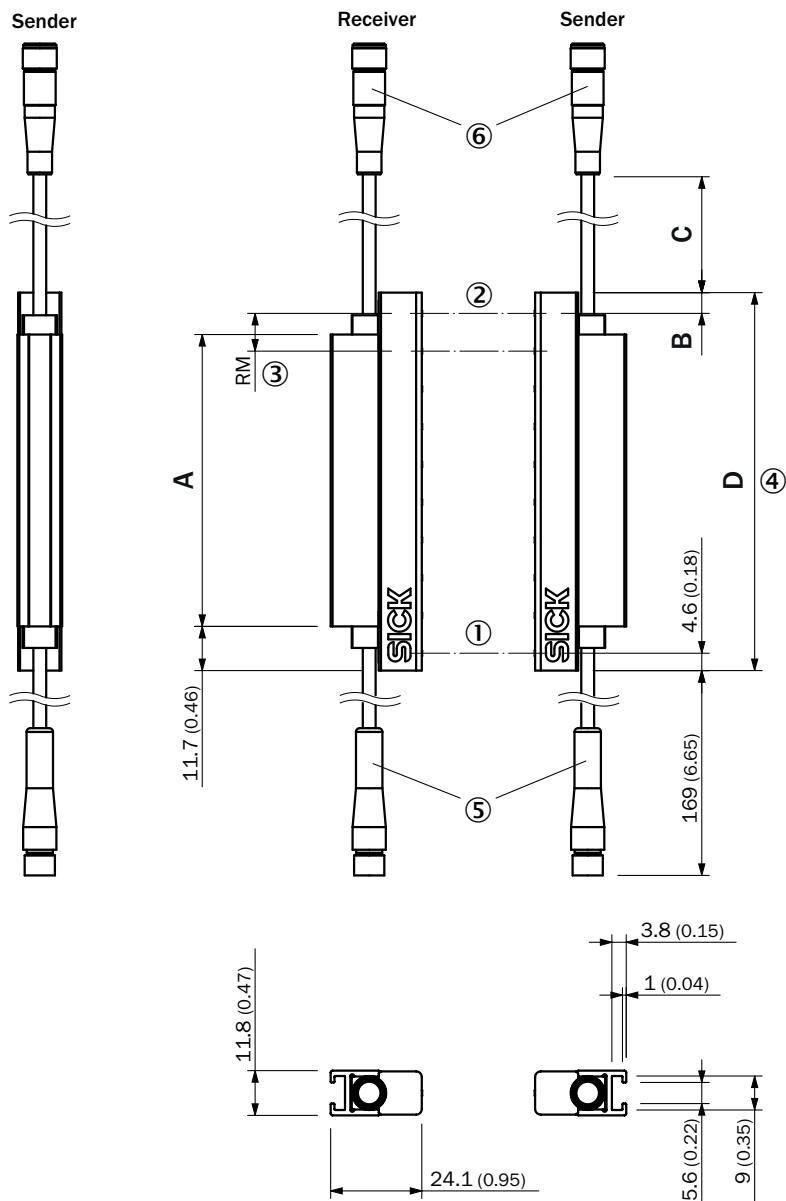

- ① First beam
- ② Last beam
- ③ Beam separation (RM)
- ④ Housing length
- ⑤ Cable with male connector, M8, 4-pin (fixed)
- ⑥ Cable with female connector, M8, 4-pin (0.5 m / 1.5 m)

#### Dimensions in mm (inch)

	Length of stabilizer	Housing length
	<b>A</b>	<b>D</b>
SLGxxx- <b>0 10</b> xxxxxxx	77 (3.03)	99,2 (3.91)
SLGxxx- <b>02 0</b> xxxxxxx	178 (7.01)	199,2 (7.84)
SLGxxx- <b>03 0</b> xxxxxxx	276 (10.87)	299,2 (11.78)
SLGxxx- <b>04 0</b> xxxxxxx	376 (14.8)	399,2 (15.72)

Dimensions in mm (inch)		
SLGxxx- <b>05 0</b> xxxxxxx	475 (18.7)	499,2 (19.65)
SLGxxx- <b>06 0</b> xxxxxxx	576 (22.68)	599,2 (23.6)
SLGxxx- <b>07 0</b> xxxxxxx	676 (26.61)	699,2 (27.53)
SLGxxx- <b>08 0</b> xxxxxxx	776 (30.55)	799,2 (31.46)
SLGxxx- <b>09 0</b> xxxxxxx	875 (34.45)	899,2 (35.4)
SLGxxx- <b>100</b> xxxxxxx	975 (38.39)	999,2 (39.34)
SLGxxx- <b>120</b> xxxxxxx	1.175 (46.26)	1.199,2 (47.21)
SLGxxx- <b>140</b> xxxxxxx	1.374 (54,09)	1.399,2 (55.09)
	Distance: Housing edge - last beam	
	<b>B<sup>1)</sup></b>	
SLG <b>10</b> x-xxxxxxxxx	4,6 (0.18)	
SLG <b>25</b> x-xxxxxxxxx	19,6 (0.77)	
SLG <b>50</b> x-xxxxxxxxx	44,6 (1.76)	
<sup>1)</sup>	for detection height less than 700 mm, the dimension deviates up to 1 mm from the dimensions specified here.	
	Length of cable	
	<b>C</b>	
SLGxxx-xxxxx <b>A</b> xxxx	500 (19.69)	
SLGxxx-xxxxx <b>B</b> xxxx	1.500 (59.06)	

### Connection type and diagram

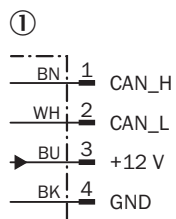

① Male connector M8, 4-pin

② Cable with female connector, M8, 4-pin

### Functional principle

Slim & Flat



- ① Slim model = light emission on narrow side
- ② Flat model = light emission on broad side

### Recommended accessories

Other models and accessories → [www.sick.com/FlexChain](http://www.sick.com/FlexChain)

	Brief description	Type	Part no.
Mounting brackets and plates			
	Side mounting for switching automation light grids, SLG-2	BEF-NUT-SLG2	2111624
	4 pieces, Mounting bracket for switching automation light grids, SLG-2	BEF-SLG2-SET1	2111623

## SICK AT A GLANCE

SICK is one of the leading manufacturers of intelligent sensors and sensor solutions for industrial applications. A unique range of products and services creates the perfect basis for controlling processes securely and efficiently, protecting individuals from accidents and preventing damage to the environment.

We have extensive experience in a wide range of industries and understand their processes and requirements. With intelligent sensors, we can deliver exactly what our customers need. In application centers in Europe, Asia and North America, system solutions are tested and optimized in accordance with customer specifications. All this makes us a reliable supplier and development partner.

Comprehensive services complete our offering: SICK LifeTime Services provide support throughout the machine life cycle and ensure safety and productivity.

For us, that is “Sensor Intelligence.”

## WORLDWIDE PRESENCE:

Contacts and other locations –[www.sick.com](http://www.sick.com)