



IM18-20NPS-ZWB

IML

INDUCTIVE PROXIMITY SENSORS

SICK
Sensor Intelligence.

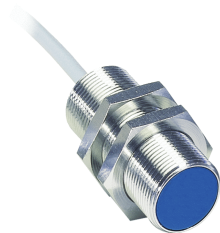

Ordering information

Type	Part no.
IM18-20NPS-ZWB	6035726

Other models and accessories → www.sick.com/IML

Illustration may differ



Detailed technical data

Features

Housing	Metric
Housing	Standard design
Thread size	M18 x 1
Diameter	Ø 18 mm
Sensing range S_n	20 mm
Installation type	Non-flush
Switching frequency	200 Hz
Connection type	Cable, 3-wire, 5 m
Switching output	PNP
Output function	NO
Electrical wiring	DC 3-wire
Enclosure rating	IP67 ¹⁾
Special features	Triple sensing range
Items supplied	Mounting nut, brass, chromium-plated (2x) Washer, brass, chromium-plated, with locking teeth (2x)

¹⁾ According to EN 60529.

Mechanics/electronics

Supply voltage	10 V DC ... 30 V DC
Ripple	≤ 20 % ¹⁾
Voltage drop	≤ 2 V ²⁾
Time delay before availability	≤ 100 ms
Hysteresis	1 % ... 15 %

¹⁾ Of V_S.

²⁾ At I_a max.

³⁾ Of S_r.

⁴⁾ UB = 20 V DC ... 30 V DC, TA = 23 °C ± 5 °C.

Reproducibility	≤ 5 % ^{3) 4)}
Temperature drift (of S_r)	± 10 %
EMC	According to EN 60947-5-2
Continuous current I_a	≤ 200 mA
Cable material	PVC
Conductor size	0.34 mm ²
Cable diameter	Ø 5 mm
Short-circuit protection	✓
Power-up pulse protection	✓
Shock and vibration resistance	30 g, 11 ms / 10 ... 55 Hz, 1 mm
Ambient operating temperature	-25 °C ... +70 °C
Housing material	Brass, chromium-plated
Sensing face material	Plastic, PTB
Housing length	50 mm
Thread length	40 mm
Tightening torque, max.	25 Nm

1) Of V_S.

2) At I_a max.

3) Of S_r.

4) UB = 20 V DC ... 30 V DC, TA = 23 °C ± 5 °C.

Safety-related parameters

MTTF_D	171 years
DC_{avg}	0%
T_M (mission time)	20 years

Installation note

Remark	Associated graphic see "Installation"
---------------	---------------------------------------

Classifications

ECLASS 5.0	27270101
ECLASS 5.1.4	27270101
ECLASS 6.0	27270101
ECLASS 6.2	27270101
ECLASS 7.0	27270101
ECLASS 8.0	27270101
ECLASS 8.1	27270101
ECLASS 9.0	27270101
ECLASS 10.0	27270101
ECLASS 11.0	27270101
ECLASS 12.0	27274001
ETIM 5.0	EC002714
ETIM 6.0	EC002714
ETIM 7.0	EC002714

ETIM 8.0	EC002714
UNSPSC 16.0901	39122230

Installation note

Non-flush installation

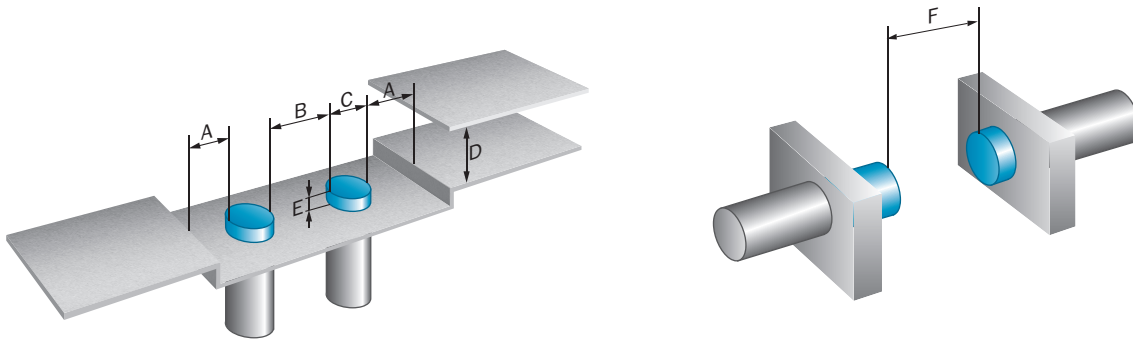

Connection type

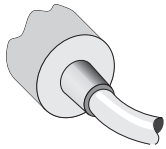

Connection diagram

Cd-001

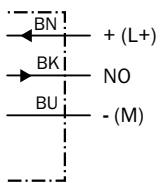

Dimensional drawing (Dimensions in mm (inch))



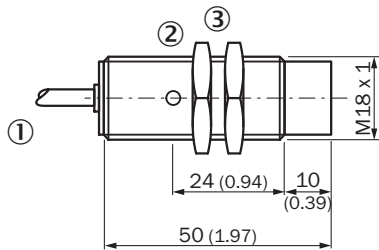

IM18 Triplex, cable, non-flush



- ① Connection
- ② Display LED
- ③ Fastening nuts (2x); width across 36, metal

Recommended accessories

Other models and accessories → www.sick.com/IML

	Brief description	Type	Part no.
Universal bar clamp systems			
	Plate N06 for universal clamp bracket, M18, Zinc plated steel (sheet), Zinc die cast (clamping bracket), Universal clamp (5322626), mounting hardware	BEF-KHS-N06	2051612
Mounting brackets and plates			
	Mounting plate for M18 sensors, steel, zinc coated, without mounting hardware	BEF-WG-M18	5321870
	Mounting bracket for M18 sensors, steel, zinc coated, without mounting hardware	BEF-WN-M18	5308446
Terminal and alignment brackets			
	Clamping block for round sensors M18, without fixed stop, plastic (PA12), glass-fiber reinforced, mounting hardware included	BEF-KH-M18	2051481

SICK AT A GLANCE

SICK is one of the leading manufacturers of intelligent sensors and sensor solutions for industrial applications. A unique range of products and services creates the perfect basis for controlling processes securely and efficiently, protecting individuals from accidents and preventing damage to the environment.

We have extensive experience in a wide range of industries and understand their processes and requirements. With intelligent sensors, we can deliver exactly what our customers need. In application centers in Europe, Asia and North America, system solutions are tested and optimized in accordance with customer specifications. All this makes us a reliable supplier and development partner.

Comprehensive services complete our offering: SICK LifeTime Services provide support throughout the machine life cycle and ensure safety and productivity.

For us, that is “Sensor Intelligence.”

WORLDWIDE PRESENCE:

Contacts and other locations –www.sick.com