



WS/WE34-B430

W34

COMPACT PHOTOELECTRIC SENSORS

SICK
Sensor Intelligence.



Illustration may differ



Ordering information

Type	Part no.
WS/WE34-B430	1019254

Other models and accessories → www.sick.com/W34

Detailed technical data

Features

Functional principle	Through-beam photoelectric sensor
Dimensions (W x H x D)	27 mm x 92 mm x 70 mm
Housing design (light emission)	Rectangular
Sensing range max.	0 m ... 60 m
Sensing range	0 m ... 60 m
Focus	Approx. 1°
Type of light	Visible red light
Light source	LED ¹⁾
Light spot size (distance)	Ø 700 mm (50 m)
Angle of dispersion	Approx. 1°
Wave length	660 nm
Adjustment	Potentiometer

¹⁾ Average service life: 100,000 h at T_U = +25 °C.

Mechanics/electronics

Supply voltage U_B	10 V DC ... 30 V DC ¹⁾
Ripple	< 5 V _{pp} ²⁾
Power consumption, sender	50 mA
Power consumption, receiver	40 mA

¹⁾ Limit values.

²⁾ May not fall below or exceed U_y tolerances.

³⁾ Signal transit time with resistive load.

⁴⁾ With light/dark ratio 1:1.

⁵⁾ A = V_S connections reverse-polarity protected.

⁶⁾ C = interference suppression.

⁷⁾ D = outputs overcurrent and short-circuit protected.

⁸⁾ Reference voltage: 50 V DC.

Switching output	NPN, PNP
Switching mode	Light switching, Dark switching
Switching mode selector	Selectable via PNP/NPN selector, selectable via light/dark selector
Output current I_{\max}	≤ 100 mA
Response time	≤ 500 μ s ³⁾
Switching frequency	1,000 Hz ⁴⁾
Angle of reception	Approx. 2.5°
Connection type	Male connector M12, 4-pin
Circuit protection	A ⁵⁾ C ⁶⁾ D ⁷⁾
Protection class	II ⁸⁾
Weight	280 g
Housing material	Plastic, ABS
Enclosure rating	IP67
Test input sender off	TE to 0 V
Ambient operating temperature	-40 °C ... +60 °C
Ambient temperature, storage	-40 °C ... +75 °C
UL File No.	NRKH.E181493 & NRKH7.E181493
Part number of individual components	2022811 WE34-B430 2022819 WS34-D430

¹⁾ Limit values.

²⁾ May not fall below or exceed U_V tolerances.

³⁾ Signal transit time with resistive load.

⁴⁾ With light/dark ratio 1:1.

⁵⁾ A = V_S connections reverse-polarity protected.

⁶⁾ C = interference suppression.

⁷⁾ D = outputs overcurrent and short-circuit protected.

⁸⁾ Reference voltage: 50 V DC.

Safety-related parameters

MTTF_D	378 years
DC_{avg}	0 %
T_M (mission time)	20 years

Classifications

ECLASS 5.0	27270901
ECLASS 5.1.4	27270901
ECLASS 6.0	27270901
ECLASS 6.2	27270901
ECLASS 7.0	27270901
ECLASS 8.0	27270901
ECLASS 8.1	27270901
ECLASS 9.0	27270901
ECLASS 10.0	27270901

ECLASS 11.0	27270901
ECLASS 12.0	27270901
ETIM 5.0	EC002716
ETIM 6.0	EC002716
ETIM 7.0	EC002716
ETIM 8.0	EC002716
UNSPSC 16.0901	39121528

Dimensional drawing (Dimensions in mm (inch))

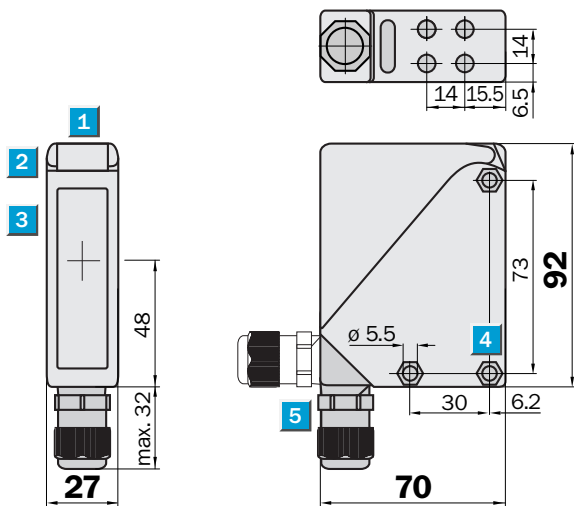

- ① Alignment sight
- ② LED signal strength indicator
- ③ Center of optical axis
- ④ Mounting hole \varnothing 5.5 mm, for M5 hexagon nuts on both sides
- ⑤ M16 screw fixing rotatable by 90°

Adjustments

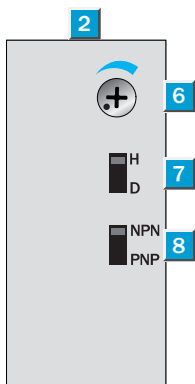

- ② LED signal strength indicator
- ⑥ Sensitivity control
- ⑦ Light/dark selector

Connection type

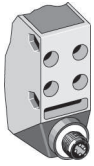

Connection diagram

Cd-118

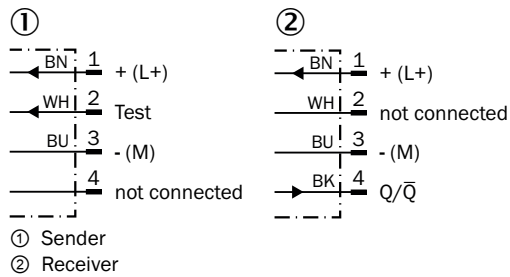

Characteristic curve

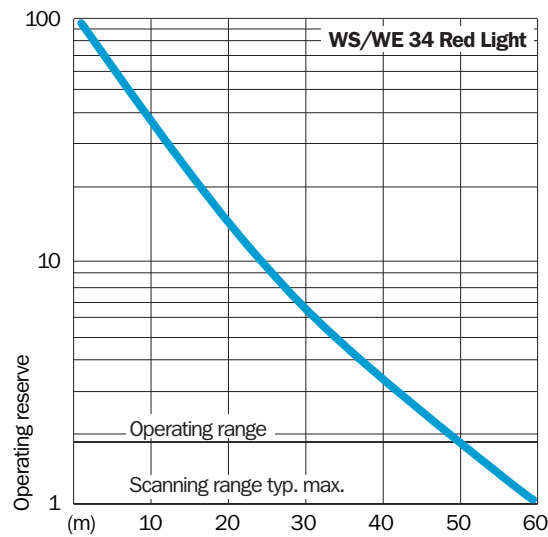

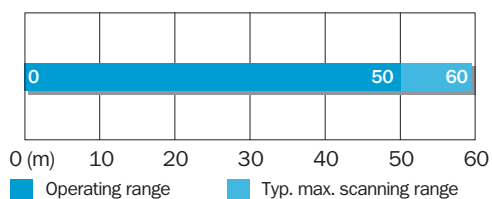

Sensing range diagram



Recommended accessories

Other models and accessories → www.sick.com/W34

	Brief description	Type	Part no.
Mounting brackets and plates			
	Mounting bracket, Stainless steel (1.4301), mounting hardware included	BEF-WN-W24	2015248
Others			
	<ul style="list-style-type: none"> • Connection type head A: Female connector, M12, 4-pin, straight, A-coded • Connection type head B: Flying leads • Signal type: Sensor/actuator cable • Cable: 5 m, 4-wire, PVC • Description: Sensor/actuator cable, unshielded • Application: Zones with chemicals 	YF2A14-050VB3XLEAX	2096235
	<ul style="list-style-type: none"> • Connection type head A: Male connector, M12, 4-pin, straight, A-coded • Description: Unshielded • Connection systems: Screw-type terminals • Permitted cross-section: ≤ 0.75 mm² 	STE-1204-G	6009932

SICK AT A GLANCE

SICK is one of the leading manufacturers of intelligent sensors and sensor solutions for industrial applications. A unique range of products and services creates the perfect basis for controlling processes securely and efficiently, protecting individuals from accidents and preventing damage to the environment.

We have extensive experience in a wide range of industries and understand their processes and requirements. With intelligent sensors, we can deliver exactly what our customers need. In application centers in Europe, Asia and North America, system solutions are tested and optimized in accordance with customer specifications. All this makes us a reliable supplier and development partner.

Comprehensive services complete our offering: SICK LifeTime Services provide support throughout the machine life cycle and ensure safety and productivity.

For us, that is “Sensor Intelligence.”

WORLDWIDE PRESENCE:

Contacts and other locations –www.sick.com