



MLG05A-0445R10501

MLG-2

MEASURING AUTOMATION LIGHT GRIDS

SICK
Sensor Intelligence.



Illustration may differ

Ordering information

| Type | Part no. |
|-------------------|----------|
| MLG05A-0445R10501 | 1213798 |

Other models and accessories → www.sick.com/MLG-2



Detailed technical data

Features

| | | | | | | | | | | | |
|--|--|----------------|--------------------|---------------------|-------------|------------------------------|--------------------|----------------------|--------------------|-------|---------------|
| Device version | Pro - Advanced functionality | | | | | | | | | | |
| Sensor principle | Sender/receiver | | | | | | | | | | |
| Minimum detectable object (MDO) | 5 mm, 9 mm ^{1) 2) 3)} | | | | | | | | | | |
| Beam separation | 5 mm | | | | | | | | | | |
| Type of synchronization | Cable | | | | | | | | | | |
| Number of beams | 90 | | | | | | | | | | |
| Detection height | 445 mm | | | | | | | | | | |
| Software features (default) | <table border="0"> <tr> <td>Q₁</td> <td>Presence detection</td> </tr> <tr> <td>Q₂ / IN</td> <td>Teach input</td> </tr> <tr> <td>Q₃</td> <td>Presence detection</td> </tr> <tr> <td>Q₄ / IN2</td> <td>Presence detection</td> </tr> <tr> <td>Teach</td> <td>Standard mode</td> </tr> </table> | Q ₁ | Presence detection | Q ₂ / IN | Teach input | Q ₃ | Presence detection | Q ₄ / IN2 | Presence detection | Teach | Standard mode |
| Q ₁ | Presence detection | | | | | | | | | | |
| Q ₂ / IN | Teach input | | | | | | | | | | |
| Q ₃ | Presence detection | | | | | | | | | | |
| Q ₄ / IN2 | Presence detection | | | | | | | | | | |
| Teach | Standard mode | | | | | | | | | | |
| Operating mode | <table border="0"> <tr> <td>Standard</td> <td>✓</td> </tr> <tr> <td>Transparent</td> <td>✓</td> </tr> <tr> <td>Dust- and sunlight-resistant</td> <td>✓</td> </tr> </table> | Standard | ✓ | Transparent | ✓ | Dust- and sunlight-resistant | ✓ | | | | |
| Standard | ✓ | | | | | | | | | | |
| Transparent | ✓ | | | | | | | | | | |
| Dust- and sunlight-resistant | ✓ | | | | | | | | | | |
| Function | <table border="0"> <tr> <td>Cross beam</td> <td>✓</td> </tr> <tr> <td>Beam blanking</td> <td>✓</td> </tr> </table> | Cross beam | ✓ | Beam blanking | ✓ | | | | | | |
| Cross beam | ✓ | | | | | | | | | | |
| Beam blanking | ✓ | | | | | | | | | | |

¹⁾ MDO min. detectable object at high measurement accuracy.

²⁾ MDO min. detectable object for standard measurement accuracy.

³⁾ Depending on beam separation without cross beam setting.

| | |
|-------------------------------|---|
| High-speed scan | ✓ |
| High measurement accuracy | ✓ |
| Applications | |
| Switching output | Object recognition/object width Object recognition Height classification Hole detection/hole size Outside dimension/inside dimension Object position Hole position Zone definition |
| Data interface | Object detection Hole detection Object height measurement Measurement of external dimension Measurement of inside dimension Measurement of object position Measurement of hole position |
| Included with delivery | 1 × sender 1 × receiver 4/6 × QuickFix brackets (6 × QuickFix brackets for monitoring heights above 2 m) 1 × Quick Start Guide |

- 1) MDO min. detectable object at high measurement accuracy.
 2) MDO min. detectable object for standard measurement accuracy.
 3) Depending on beam separation without cross beam setting.

Mechanics/electronics

| | |
|--|--|
| Light source | LED, Infrared light |
| Wave length | 850 nm |
| Supply voltage V_s | DC 19.2 V ... 28.8 V ¹⁾ |
| Power consumption sender | 59.5 mA ²⁾ |
| Power consumption receiver | 138 mA ²⁾ |
| Ripple | < 5 V _{pp} |
| Output current I_{max} | 100 mA |
| Output load, capacitive | 100 nF |
| Output load, Inductive | 1 H |
| Initialization time | < 1 s |
| Switching output | Push-pull: PNP/NPN |
| Connection type | Male connector M12, 5-pin, 0.22 m Male connector M12, 8-pin, 0.27 m M12 female connector, 4-pin, D-coded, 0.19 m |
| Housing material | Aluminum |
| Indication | LED |
| Enclosure rating | IP65, IP67 ³⁾ |
| Circuit protection | U _V connections, reverse polarity protected Output Q short-circuit protected Interference pulse suppression |

- 1) Without load.
 2) Without load with 24 V.
 3) Operating in outdoor condition only with a external protection housing.

| | |
|-------------------------|--------------|
| Protection class | III |
| Weight | 1.149 kg |
| Front screen | PMMA |
| Option | None |
| UL File No. | NRKH.E181493 |

¹⁾ Without load.

²⁾ Without load with 24 V.

³⁾ Operating in outdoor condition only with a external protection housing.

Performance

| | |
|------------------------|----------------------|
| Maximum range | 7 m ¹⁾ |
| Minimum range | ≥ 0 m |
| Operating range | 5 m |
| Response time | 8.2 ms ²⁾ |

¹⁾ No reserve for environmental issue and deterioration of the diode.

²⁾ Without high speed.

Communication interface

| | |
|------------------------|-----------------------------------|
| IO-Link | ✓, IO-Link V1.1 |
| Data transmission rate | 230,4 kbit/s (COM3) |
| Maximum cable length | 20 m |
| Cycle time | 2.3 ms |
| VendorID | 26 |
| DeviceID HEX | 800068 |
| DeviceID DEC | 8388712 |
| Process data length | 32 Byte (TYPE_2_V) ¹⁾ |
| Inputs/outputs | 4 x Q (IO-Link) |
| Digital output | Q ₁ ... Q ₄ |
| Number | 4 |
| Digital input | In ₁ , In ₂ |
| Number | 2 |

¹⁾ With an IO-Link master with V1.0, fall back to interleaved mode (consisting of TYPE_1_1 (ProcessData) and TYPE_1_2 (On-request Data)).

Ambient data

| | |
|--------------------------------------|--|
| Shock resistance | Continuous shocks 10 g, 16 ms, 1000 shocks Single shocks 15 g, 11 ms 3 per axle |
| Vibration resistance | Sinusoidal oscillation 10-150 Hz 5 g |
| EMC | EN 60947-5-2 |
| Ambient light immunity | Direct: 150,000 lx ¹⁾ Indirect: 200,000 lx ²⁾ |
| Ambient operating temperature | -30 °C ... +55 °C |
| Ambient temperature, storage | -40 °C ... +70 °C |

¹⁾ Outdoor mode.

²⁾ Light resistance indirect.

Smart Task

| Smart Task name | Base logics |
|-----------------|-------------|
|-----------------|-------------|

Classifications

| | |
|-----------------------|----------|
| ECLASS 5.0 | 27270910 |
| ECLASS 5.1.4 | 27270910 |
| ECLASS 6.0 | 27270910 |
| ECLASS 6.2 | 27270910 |
| ECLASS 7.0 | 27270910 |
| ECLASS 8.0 | 27270910 |
| ECLASS 8.1 | 27270910 |
| ECLASS 9.0 | 27270910 |
| ECLASS 10.0 | 27270910 |
| ECLASS 11.0 | 27270910 |
| ECLASS 12.0 | 27270910 |
| ETIM 5.0 | EC002549 |
| ETIM 6.0 | EC002549 |
| ETIM 7.0 | EC002549 |
| ETIM 8.0 | EC002549 |
| UNSPSC 16.0901 | 39121528 |

Dimensional drawing (Dimensions in mm (inch))

Dimensional drawing



| | A ¹⁾ | B ²⁾ |
|-----------------------------|-------------------------|-----------------|
| Strahlabstand 2,5 mm | 62,25 | 17,15 |
| Strahlabstand 5 mm | 63,3 | 16,1 |
| Strahlabstand 10 mm | 68,3 | 16,1 |
| Strahlabstand 20 mm | 68,3/78,3 ³⁾ | 16,1 |
| Strahlabstand 25 mm | 83,3 | 16,1 |
| Strahlabstand 30 mm | 88,3 | 16,1 |
| Strahlabstand 50 mm | 108,3 | 16,1 |

¹⁾ Abstand: MLG-2 Kante - erster Strahl

²⁾ Abstand: MLG-2 Kante - letzter Strahl

³⁾ MLG20x-xx**40**: 68,3 mm
 MLG20x-xx**80**: 78,3 mm

- ① First beam
- ② Last beam
- ③ Detection height (see technical data)

- ④ Beam separation
- ⑤ Optical axis
- ⑥ Status indicator: green, yellow, red LEDs
- ⑦ Connection

Connection type and diagram

Connector M12, 5/8-pin, switching outputs Q

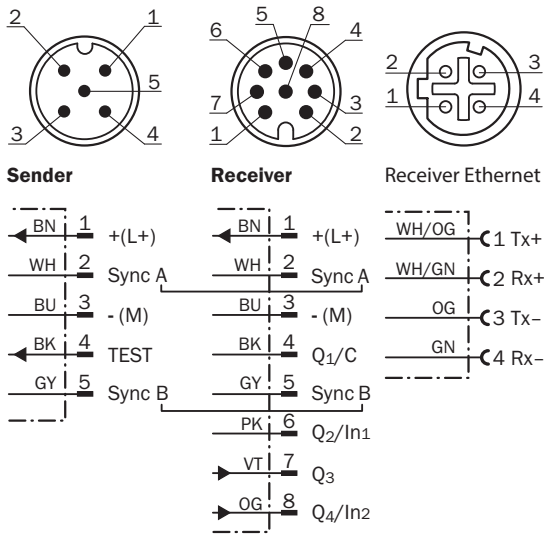

Pinouts



- ① Connection cable receiver (2096010)
- ② T-piece
- ③ Connection cable (6020664)
- ④ Ethernet Connection cable

Adjustments

Adjustments



① Status indicator: green, yellow, red LEDs

Connection diagram

T-junction, PLC









T-junction, IO-Link-Master



Recommended accessories

Other models and accessories → www.sick.com/MLG-2

| | Brief description | Type | Part no. |
|---|---|--------------------|----------|
| Plug connectors and cables | | | |
|  | <ul style="list-style-type: none"> Connection type head A: Male connector, M12, 4-pin, straight, D-coded Connection type head B: Male connector, RJ45, 4-pin, straight Signal type: Ethernet, PROFINET Cable: 5 m, 4-wire, PUR, halogen-free Description: Ethernet, PROFINET, shielded Application: Drag chain operation, Zones with oils and lubricants | YM2D24-050PN1MRJA4 | 2106184 |
| Others | | | |
|  | <ul style="list-style-type: none"> Connection type head A: Female connector, M12, 5-pin, A-coded Connection type head B: Female connector, M12, 8-pin, A-coded Connection type head C: Male connector, M12, 8-pin, A-coded Note: Male connector M12, 8-pin, to 1 x female connector M12, 8-pin, to 1 x female connector M12, 5-pin, for connecting of a PLC | SBO-02F12-SM1 | 6053172 |
|  | <ul style="list-style-type: none"> Connection type head A: Female connector, M12, 8-pin, straight Connection type head B: Flying leads Signal type: Sensor/actuator cable Cable: 5 m, 8-wire, PVC Description: Sensor/actuator cable, special color code, shielded Connection systems: Flying leads | DOL-1208-G05MF | 6020664 |
|  | <ul style="list-style-type: none"> Connection type head A: Female connector, M12, 5-pin, straight, A-coded Connection type head B: Male connector, M12, 5-pin, straight, A-coded Signal type: Sensor/actuator cable Cable: 5 m, 5-wire, PUR, halogen-free Description: Sensor/actuator cable, unshielded Application: Zones with oils and lubricants, Drag chain operation, Robot | YF2A15-050UB5M2A15 | 2096010 |

| | Brief description | Type | Part no. |
|---|--|------------------|----------|
| Sensor Integration Gateway | | | |
|  | <ul style="list-style-type: none"> • Further functions: Web server integrated, USB connection for easy configuration of the SIG200 Sensor Integration Gateway with SOPAS ET, the engineering tool from SICK, logic editor is available for easy configuration of logic functions • Connection CONFIG: 1 x M8, 4-pin female connector, USB 2.0 (USB-A) • Logic editor: yes • Communication interface: IO-Link, USB, Ethernet, PROFINET, REST API • Product category: IO-Link Master | SIG200-0A0412200 | 1089794 |
|  | <ul style="list-style-type: none"> • Further functions: Web server integrated, USB connection for easy configuration of the SIG200 Sensor Integration Gateway with SOPAS ET, the engineering tool from SICK, logic editor is available for easy configuration of logic functions • Connection CONFIG: 1 x M8, 4-pin female connector, USB 2.0 (USB-A) • Logic editor: yes • Communication interface: IO-Link, USB, Ethernet, REST API • Product category: IO-Link Master | SIG200-0A0G12200 | 1102605 |

SICK AT A GLANCE

SICK is one of the leading manufacturers of intelligent sensors and sensor solutions for industrial applications. A unique range of products and services creates the perfect basis for controlling processes securely and efficiently, protecting individuals from accidents and preventing damage to the environment.

We have extensive experience in a wide range of industries and understand their processes and requirements. With intelligent sensors, we can deliver exactly what our customers need. In application centers in Europe, Asia and North America, system solutions are tested and optimized in accordance with customer specifications. All this makes us a reliable supplier and development partner.

Comprehensive services complete our offering: SICK LifeTime Services provide support throughout the machine life cycle and ensure safety and productivity.

For us, that is “Sensor Intelligence.”

WORLDWIDE PRESENCE:

Contacts and other locations –www.sick.com