



FUM-H015F1NC50000

DOSIC

FLOW SENSORS

SICK
Sensor Intelligence.



Illustration may differ



Ordering information

Type	Part no.
FUM-H015F1NC50000	1082022

Other models and accessories → www.sick.com/DOSIC

Detailed technical data

Features

Measurement principle	Ultrasonic sensor
Measurement	Ultrasonic
Medium	Conductive and non-conductive liquids
Nominal width measuring tube	DN 15
Process temperature	-20 °C ... +95 °C, up to 143 °C for 60 minutes for SIP process (temperature measurement only) ¹⁾
Process pressure	-0.5 bar ... 16 bar
Communication interface	IO-Link, IO-Link V1.1
EHEDG approval	✓
cULus certificate	✓
RoHS certificate	✓
FDA	✓
Temperature measurement	✓

¹⁾ 0 °C ... +95 °C with flow and temperature measurement; up to 143 °C only with temperature measurement.

Performance

Minimum flow	≥ 0.5 l/min
Maximum flow	≥ 80 l/min
Inlet zone	5 x DN (7.5 cm)
Output zone	3 x DN (4.5 cm)
Conductivity	No limitation
Measurement accuracy	

¹⁾ Under the following reference conditions: water 26 °C ± 2 K, 2.5 bar ± 0.5 bar, standard settings, DN15: 8 l/min ... 80 l/min, DN25: 25 l/min ... 250 l/min.

	± 1 % From measured value ¹⁾
Repeatability	0.5 %
Resolution	10 ml/min
Response time	12 ms

¹⁾ Under the following reference conditions: water 26 °C ± 2 K, 2.5 bar ± 0.5 bar, standard settings, DN15: 8 l/min ... 80 l/min, DN25: 25 l/min ... 250 l/min.

Electronics

Supply voltage	12 V DC ... 30 V DC ¹⁾
Power consumption	< 3 W without output load
Initialization time	≤ 5 s
Protection class	III
Connection type	Round connector M12 x 1, 5-pin
Output signal	1 x analog output: 4 mA ... 20 mA, 2 x digital input or output (configurable) ^{2) 3)}
Output load	4 mA ... 20 mA, 500 ohms when U _v > 15 V, 350 ohms when U _v > 12 V
Lower signal level	3.5 mA ... 3.8 mA
Upper signal level	21.5 mA ... 20.5 mA
Digital output	≤ 100 mA
Impulse output signal	50 μs ... 2 s
Impuls/frequency output	0 kHz ... 10 kHz
Inductive load	< 1 H
Capacitive load	< 100 nF < 2.5 nF (IO-Link)
EMC	EN 61326-1, EN 61326-2-3
Limit digital inputs	HIGH state voltage > 16.0 V, LOW state voltage < 4.0 V
MTTF	> 63 years

¹⁾ All connections are reverse polarity protected. Q_A is short-circuit protected. Q1 and Q2 are short-circuit protected.

²⁾ Digital output configuration: PNP/NPN/push-pull/open collector.

³⁾ Selectable analog output: flow/temperature.

Mechanics

Process connection	¾" NPT
Wetted parts	Stainless steel 1.4404 (Ra ≤ 0,8 μm)
Housing material	Stainless steel 1,4305
Housing design	With viewing window made from PMMA (acrylic glass)
Enclosure rating	IP67/IP69 (DIN EN 60529)
Weight	Approx. 2 kg

Ambient data

Ambient operating temperature	0 °C ... +60 °C
Ambient temperature, storage	-40 °C ... +80 °C

Classifications

ECLASS 5.0	27200412
ECLASS 5.1.4	27200412
ECLASS 6.0	27200412

ECLASS 6.2	27200412
ECLASS 7.0	27200412
ECLASS 8.0	27200412
ECLASS 8.1	27200412
ECLASS 9.0	27200412
ECLASS 10.0	27200412
ECLASS 11.0	27200412
ECLASS 12.0	27200412
ETIM 5.0	EC002580
ETIM 6.0	EC002580
ETIM 7.0	EC002580
ETIM 8.0	EC002580
UNSPSC 16.0901	41112501

Dimensional drawing (Dimensions in mm (inch))

Dimensional drawing process connection

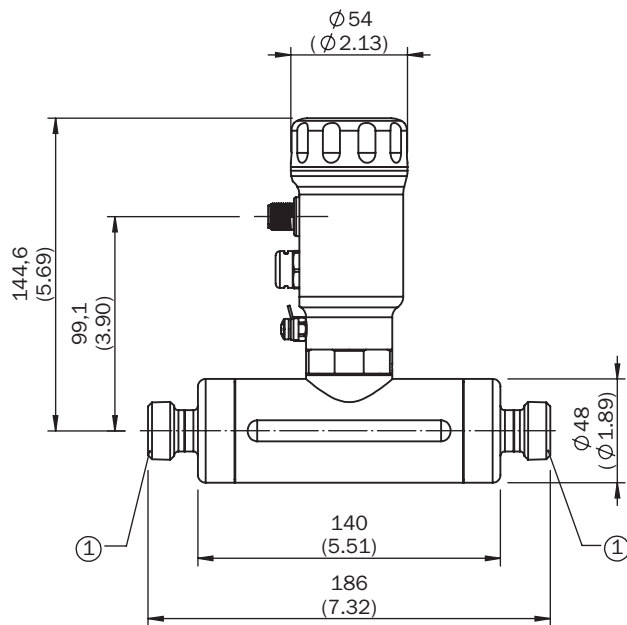

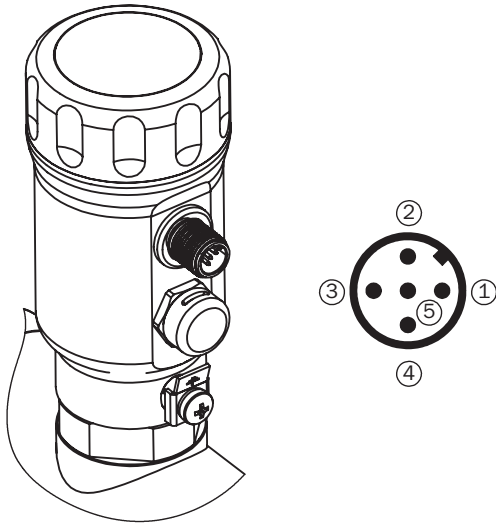

Connection type

















- ① L⁺: Supply voltage
- ② Q_A: analog current output 4 mA ... 20 mA
- ③ M: Ground, reference potential for current output
- ④ C/Q1: Switching output/input 1, PNP/NPN/push-pull/open collector/IO-Link communication
- ⑤ Q2: Switching output/input 2, PNP/NPN/push-pull/open collector/frequency/pulse output

Recommended accessories

Other models and accessories → www.sick.com/DOSIC

	Brief description	Type	Part no.
Connection modules			
	IO-Link V1.1 Class A port, USB2.0 port, optional external power supply 24V / 1A	IOLA2US-01101 (SiLink2 Master)	1061790
Spare parts			
	Cover closed, material 1.4305	Cover closed	2067269
	<ul style="list-style-type: none"> • Connection type head A: Female connector, M12, 5-pin, straight • Connection type head B: Flying leads • Signal type: Sensor/actuator cable • Cable: 2 m, 5-wire, PVC • Description: Sensor/actuator cable, unshielded • Connection systems: Flying leads • Note: This product is generally resistant to chemical cleaning agents (see ECOLAB). Please do not use cleaning agents of any other Kind., Not resistant against lactic acid & hydrogen peroxide (H2O2) • Application: Hygienic and washdown zones 	DOL-1205-G02MNI	6052625

	Brief description	Type	Part no.
	<ul style="list-style-type: none"> Connection type head A: Female connector, M12, 5-pin, straight Connection type head B: Flying leads Signal type: Sensor/actuator cable Cable: 5 m, 5-wire, PVC Description: Sensor/actuator cable, unshielded Connection systems: Flying leads Note: This product is generally resistant to chemical cleaning agents (see ECOLAB). Please do not use cleaning agents of any other Kind., Not resistant against lactic acid & hydrogen peroxide (H2O2) Application: Hygienic and washdown zones 	DOL-1205-G05MNI	6052626
	<ul style="list-style-type: none"> Connection type head A: Female connector, M12, 5-pin, straight Connection type head B: Flying leads Signal type: Sensor/actuator cable Cable: 10 m, 5-wire, PVC Description: Sensor/actuator cable, unshielded Connection systems: Flying leads Note: This product is generally resistant to chemical cleaning agents (see ECOLAB). Please do not use cleaning agents of any other Kind., Not resistant against lactic acid & hydrogen peroxide (H2O2) Application: Hygienic and washdown zones 	DOL-1205-G10MNI	6052627
	<ul style="list-style-type: none"> Connection type head A: Female connector, M12, 5-pin, angled, A-coded Connection type head B: Flying leads Signal type: Sensor/actuator cable Cable: 2 m, 5-wire, PVC Description: Sensor/actuator cable, unshielded Application: Zones with chemicals 	YG2A15-020VB5XLEAX	2096215
	<ul style="list-style-type: none"> Connection type head A: Female connector, M12, 5-pin, angled, A-coded Connection type head B: Flying leads Signal type: Sensor/actuator cable Cable: 5 m, 5-wire, PVC Description: Sensor/actuator cable, unshielded Application: Zones with chemicals 	YG2A15-050VB5XLEAX	2096216
	<ul style="list-style-type: none"> Connection type head A: Female connector, M12, 5-pin, angled, A-coded Connection type head B: Flying leads Signal type: Sensor/actuator cable Cable: 10 m, 5-wire, PVC Description: Sensor/actuator cable, unshielded Application: Zones with chemicals 	YG2A15-100VB5XLEAX	2096217
	<ul style="list-style-type: none"> Connection type head A: Female connector, M12, 5-pin, straight, A-coded Connection type head B: Flying leads Signal type: Sensor/actuator cable Cable: 2 m, 5-wire, PUR, halogen-free Description: Sensor/actuator cable, unshielded Application: Zones with oils and lubricants, Drag chain operation, Robot 	YF2A15-020UB5XLEAX	2095617
	<ul style="list-style-type: none"> Connection type head A: Female connector, M12, 5-pin, straight, A-coded Connection type head B: Flying leads Signal type: Sensor/actuator cable Cable: 5 m, 5-wire, PUR, halogen-free Description: Sensor/actuator cable, unshielded Application: Zones with oils and lubricants, Drag chain operation, Robot 	YF2A15-050UB5XLEAX	2095618
	<ul style="list-style-type: none"> Connection type head A: Female connector, M12, 5-pin, straight, A-coded Connection type head B: Flying leads Signal type: Sensor/actuator cable Cable: 10 m, 5-wire, PUR, halogen-free Description: Sensor/actuator cable, unshielded Application: Zones with oils and lubricants, Drag chain operation, Robot 	YF2A15-100UB5XLEAX	2095619
	<ul style="list-style-type: none"> Connection type head A: Female connector, M12, 5-pin, angled, A-coded Connection type head B: Flying leads Signal type: Sensor/actuator cable Cable: 2 m, 5-wire, PUR, halogen-free Description: Sensor/actuator cable, unshielded Application: Zones with oils and lubricants, Drag chain operation, Robot 	YG2A15-020UB5XLEAX	2095772

	Brief description	Type	Part no.
	<ul style="list-style-type: none"> • Connection type head A: Female connector, M12, 5-pin, angled, A-coded • Connection type head B: Flying leads • Signal type: Sensor/actuator cable • Cable: 5 m, 5-wire, PUR, halogen-free • Description: Sensor/actuator cable, unshielded • Application: Zones with oils and lubricants, Drag chain operation, Robot 	YG2A15-050UB5XLEAX	2095773
	<ul style="list-style-type: none"> • Connection type head A: Female connector, M12, 5-pin, angled, A-coded • Connection type head B: Flying leads • Signal type: Sensor/actuator cable • Cable: 10 m, 5-wire, PUR, halogen-free • Description: Sensor/actuator cable, unshielded • Application: Zones with oils and lubricants, Drag chain operation, Robot 	YG2A15-100UB5XLEAX	2095774
	<ul style="list-style-type: none"> • Connection type head A: Female connector, M12, 5-pin, straight, A-coded • Connection type head B: Flying leads • Signal type: Sensor/actuator cable • Cable: 2 m, 5-wire, PVC • Description: Sensor/actuator cable, unshielded • Application: Zones with chemicals 	YF2A15-020VB5XLEAX	2096239
	<ul style="list-style-type: none"> • Connection type head A: Female connector, M12, 5-pin, straight, A-coded • Connection type head B: Flying leads • Signal type: Sensor/actuator cable • Cable: 5 m, 5-wire, PVC • Description: Sensor/actuator cable, unshielded • Application: Zones with chemicals 	YF2A15-050VB5XLEAX	2096240
	<ul style="list-style-type: none"> • Connection type head A: Female connector, M12, 5-pin, straight, A-coded • Connection type head B: Flying leads • Signal type: Sensor/actuator cable • Cable: 10 m, 5-wire, PVC • Description: Sensor/actuator cable, unshielded • Application: Zones with chemicals 	YF2A15-100VB5XLEAX	2096241

Recommended services

Additional services → www.sick.com/DOSIC

	Type	Part no.
Function Block Factory		
<ul style="list-style-type: none"> • Description: The Function Block Factory supports common programmable logic controllers (PLCs) from various manufacturers, such as Siemens, Beckhoff, Rockwell Automation and B&R. More information on the FBF can be found <a _blank"="" href="https://fbf.cloud.sick.com target=">here. • Note: You can configure your function block at <a _blank"="" href="https://fbf.cloud.sick.com target=">Function Block Factory. As a login please use your SICK ID. 	Function Block Factory	On request

SICK AT A GLANCE

SICK is one of the leading manufacturers of intelligent sensors and sensor solutions for industrial applications. A unique range of products and services creates the perfect basis for controlling processes securely and efficiently, protecting individuals from accidents and preventing damage to the environment.

We have extensive experience in a wide range of industries and understand their processes and requirements. With intelligent sensors, we can deliver exactly what our customers need. In application centers in Europe, Asia and North America, system solutions are tested and optimized in accordance with customer specifications. All this makes us a reliable supplier and development partner.

Comprehensive services complete our offering: SICK LifeTime Services provide support throughout the machine life cycle and ensure safety and productivity.

For us, that is “Sensor Intelligence.”

WORLDWIDE PRESENCE:

Contacts and other locations –www.sick.com