



# LFV330-XXGBVXPN0180

LFV300

LEVEL SENSORS

**SICK**  
Sensor Intelligence.



Illustration may differ



### Ordering information

Type	Part no.
LFV330-XXGBVXPN0180	6064661

Other models and accessories → [www.sick.com/LFV300](http://www.sick.com/LFV300)

### Detailed technical data

#### Features

<b>Medium</b>	Fluids
<b>Measurement</b>	Switch
<b>Probe length</b>	180 mm
<b>Process pressure</b>	-1 bar ... 64 bar
<b>Process temperature</b>	-50 °C ... +150 °C
<b>Fill material density</b>	0.5 g/cm <sup>3</sup> ... 2.5 g/cm <sup>3</sup>

#### Performance

<b>Accuracy of sensor element</b>	± 2 mm
<b>Reproducibility</b>	≤ 1 mm
<b>Viscosity</b>	0.1 mPas ... 10,000 mPas
<b>Response time</b>	500 ms
<b>MTBF</b>	9,73*10 <sup>6</sup> h

#### Electronics

<b>Residual ripple</b>	≤ 5 V <sub>pp</sub>
<b>Power consumption</b>	1 mA / 2,5 mA
<b>Initialization time</b>	< 2 s
<b>VDE protection class 2</b>	✓
<b>Connection type</b>	M20 x 1.5
<b>Output signal</b>	NAMUR signal
<b>Supply voltage</b>	NAMUR signal: 4.5 V DC ... 12 V DC
<b>Hysteresis</b>	2 mm
<b>Output current</b>	1 mA / 2,5 mA
<b>Enclosure rating</b>	IP66 / IP67
<b>Temperature drift</b>	0,03 mm/K

#### Mechanics

<b>Wetted parts</b>	Stainless steel 316L (optional Ra ≤ 0.8 μm)
---------------------	---

<b>Process connection</b>	G 3/4 A PN 64 / 1.4404
<b>Housing material</b>	Plastic
<b>Sensor material</b>	Stainless steel 1.4404

Ambient data

<b>Ambient operating temperature</b>	-40 °C ... +70 °C
<b>Ambient temperature, storage</b>	-40 °C ... +80 °C

Classifications

<b>ECLASS 5.0</b>	27273202
<b>ECLASS 5.1.4</b>	27273202
<b>ECLASS 6.0</b>	27273202
<b>ECLASS 6.2</b>	27273202
<b>ECLASS 7.0</b>	27273202
<b>ECLASS 8.0</b>	27273202
<b>ECLASS 8.1</b>	27273202
<b>ECLASS 9.0</b>	27273202
<b>ECLASS 10.0</b>	27273202
<b>ECLASS 11.0</b>	27273202
<b>ECLASS 12.0</b>	27273106
<b>ETIM 5.0</b>	EC002654
<b>ETIM 6.0</b>	EC002654
<b>ETIM 7.0</b>	EC002654
<b>ETIM 8.0</b>	EC002654
<b>UNSPSC 16.0901</b>	41111938

Type code

LFV330 type code

**Certification**

XX	Without approval
XA	WHG approval
CA	ATEX II 1G, 1/2G, 2G Ex ia IIC T6 Ga, Ga/Gb, Gb +WHG
DA	ATEX II 1/2G Ex db IIC T6...T2 Ga/Gb +WHG

**Process connection/Material (see below)**

**Middle section / Process temperature**

X	without / -50 °C ... +150 °C
T	with / -50 °C ... +250 °C

**Housing / Cable screw connection**

P	Plastics IP 66, IP 67 / M20 x 1,5
N	Plastics IP 66, IP 67 / 1/2" NPT
M	Aluminium IP 66, IP 67 / M20 x 1,5
U	Aluminium IP 66, IP 67 / 1/2" NPT
V	Stainless steel (precision casting) 316L IP66, IP67 / M20 x 1,5
A	Stainless steel (precision casting) 316L IP 66, IP 67 1/2" NPT
8	Stainless steel (electro buffed) 316L IP 66, IP 67 / M20 x 1,5
9	Stainless steel (electro buffed) 316L IP 66, IP 67 / 1/2" NPT

**Electronics**

C	Contactless switch 20...253VAC(DC)
---	------------------------------------

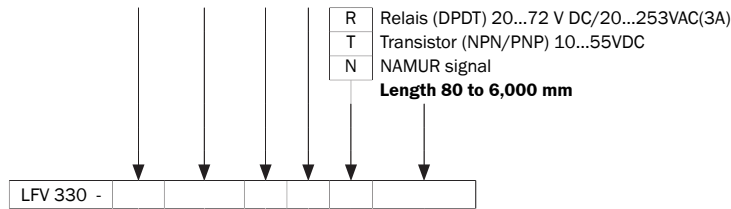

Not all variations of the type code can be combined! Not all available variations are shown.

### Process connection/Material

GBV	Thread G 3/4 A PN 64 / 316L	PLV	Flange DN 125, PN 40 Form N, DIN 2501 / 316L
GBP	Thread G 3/4 A PN 64 / 316L Ra<0,8µm	FMV	Flange DN 150, PN 16 Form C, DIN 2501 / 316L
NBV	Thread 3/4" NPT PN 64 / 316L	MMV	Flange DN 150, PN 16 Form D, DIN 2501 / 316L
NBP	Thread 3/4" NPT PN 64 / 316L Ra<0,8µm	FVV	Flange DN 150, PN 40 Form C, DIN 2501 / 316L
GAV	Thread G 1 A PN 64 / 316L	OVV	Flange DN 150, PN 40 Form F, DIN 2501 / 316L
GAP	Thread G 1 A PN 64 / 316L Ra<0,8µm	PVV	Flange DN 150, PN 40 Form N, DIN 2501 / 316L
NAV	Thread 1" NPT PN 64 / 316L	FQV	Flange DN 200, PN 16 Form C, DIN 2501 / 316L
NAP	Thread 1" NPT PN 64 / 316L Ra<0,8µm	F5V	Flange DN 250, PN 10 Form C, DIN 2501 / 316L
GCV	Thread G 1 1/2 A PN 64 / 316L	UCV	Flange DN 40, PN 40 V13, DIN 2501 / 316L
NCV	Thread 1 1/2" NPT PN 64 / 316L	FEV	Flange DN 50, PN 40 Form C, DIN 2501 / 316L
TAP	Varivent N50-40 / 316L Ra<0,8µm ZB3052	RCP	Fitting DN 25, PN 40, DIN 11851 / 316L Ra<0,8µm
TNP	Varivent N25-100 / 316L Ra<0,8µm ZB3052	REP	Fitting DN 32, PN 40, DIN 11851 / 316L Ra<0,8µm
CCP	Tri-Clamp 1" PN 16 / 316L Ra<0,8µm	RAP	Fitting DN 40, PN 40, DIN 11851 / 316L Ra<0,8µm
CBP	Tri-Clamp 1 1/2" PN 16 / 316L Ra<0,8µm	RFP	Fitting DN 40, PN 40, DIN 11864-1A / 316L Ra<0,8µm ZB3052
CAP	Tri-Clamp 2" PN 16 / 316L Ra<0,8µm	RBP	Fitting DN 50, PN 25, DIN 11851 / 316L Ra<0,8µm
CDP	Tri-Clamp 2 1/2" PN 10 / 316L Ra<0,8µm	RDP	Fitting DN 50, PN 25, DIN 11864-1A / 316L Ra<0,8µm ZB3052
CEP	Tri-Clamp 3" PN 10 / 316L Ra<0,8µm		

Dimensional drawing (Dimensions in mm (inch))

LFV330

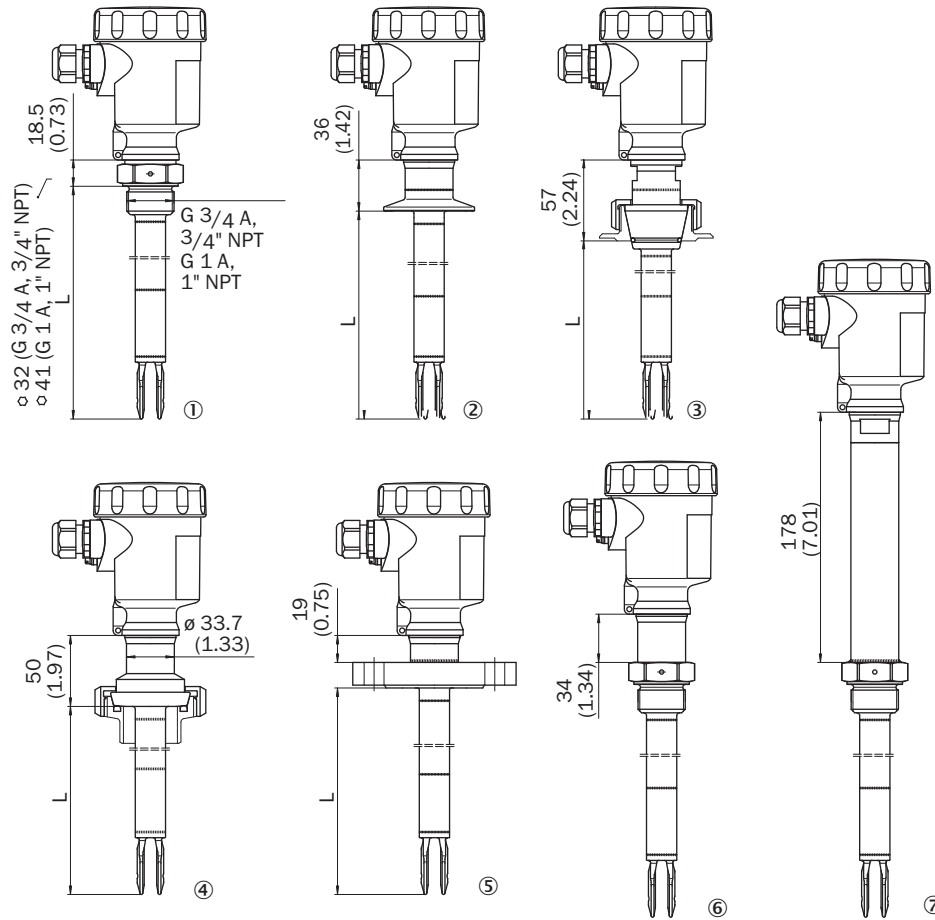

- ① Thread
- ② Tri-Clamp
- ③ DN 25 cone
- ④ Bolting D 40
- ⑤ Flange
- ⑥ Gas-tight leadthrough
- ⑦ Temperature adapter

Marking on the welded flange

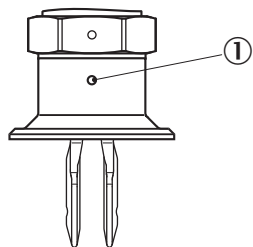

- ① Marking

### Connection diagram

Namur connection diagram



Namur - electronic module



- ① Signal lamp (LED)
- ② DIL switch for characteristics reversal
- ③ DIL-switch for sensitivity adjustment
- ④ Simulation key

### Instruction for installation

Inflowing medium



### Characteristic curve





Influence of the process temperature on the switching point



- ① Shifting of the switching point in mm (in)
- ② Process temperature in °C (°F)
- ③ Switching point at reference conditions (notch)
- ④ Tuning fork

### Recommended accessories

Other models and accessories → [www.sick.com/LFV300](http://www.sick.com/LFV300)

	Brief description	Type	Part no.
<b>Electronic modules</b>			
	Namur signal: 4.5 V DC ... 12 V DC	ECD-RE-LFV-NAM-0001	6038670
<b>Flanges</b>			
	Welded flange/welded connector, DIN11851-1, DN25 / PN40, Stainless steel 1.4404	BEF-FL-851D25-LFV2	5321527
	Welded flange/welded connector, process connection G 1, Stainless steel 1.4404	BEF-FL-GEWG10-LFV2	4054605
	Welded flange/welded connector, G 3/4 process connection, Stainless steel 1.4404	BEF-FL-GEWG34-LFV2	4054604
	Welded flange/welded connector, process connection Tri-Clamp 1", Stainless steel 1.4404	BEF-FL-TCLI10-LFV2	5321678
	Welded flange/welded connector, process connection Tri-Clamp 2", Stainless steel 1.4404	BEF-FL-TCLI20-LFV2	5321679
<b>Mounting brackets and plates</b>			
	BEF-MU-316G10-ALFV	BEF-MU-316G10-ALFV	5322463

## SICK AT A GLANCE

SICK is one of the leading manufacturers of intelligent sensors and sensor solutions for industrial applications. A unique range of products and services creates the perfect basis for controlling processes securely and efficiently, protecting individuals from accidents and preventing damage to the environment.

We have extensive experience in a wide range of industries and understand their processes and requirements. With intelligent sensors, we can deliver exactly what our customers need. In application centers in Europe, Asia and North America, system solutions are tested and optimized in accordance with customer specifications. All this makes us a reliable supplier and development partner.

Comprehensive services complete our offering: SICK LifeTime Services provide support throughout the machine life cycle and ensure safety and productivity.

For us, that is “Sensor Intelligence.”

## WORLDWIDE PRESENCE:

Contacts and other locations –[www.sick.com](http://www.sick.com)