



# IMI30-10BNSNU2S

IMI

INDUCTIVE PROXIMITY SENSORS

**SICK**  
Sensor Intelligence.

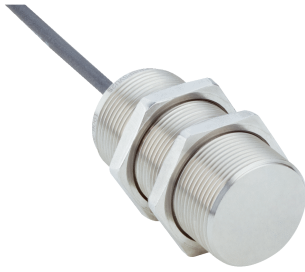

## Ordering information

Type	Part no.
IMI30-10BNSNU2S	1093954

**Included in delivery:** BEF-MU-M30N1 (1)

Other models and accessories → [www.sick.com/IMI](http://www.sick.com/IMI)

Illustration may differ



## Detailed technical data

### Features

<b>Housing</b>	Metric
<b>Thread size</b>	M30 x 1.5
<b>Diameter</b>	Ø 30 mm
<b>Sensing range <math>S_n</math></b>	10 mm
<b>Safe sensing range <math>S_a</math></b>	8.1 mm
<b>Installation type</b>	Flush
<b>Switching frequency</b>	50 Hz
<b>Connection type</b>	Cable, 3-wire, 2 m
<b>Switching output</b>	NPN
<b>Output function</b>	NO
<b>Electrical wiring</b>	DC 3-wire
<b>Enclosure rating</b>	IP68, IP69K <sup>1)</sup>
<b>Special features</b>	Sensing face made of stainless steel V4A, Resistant to cleaning agents
<b>Special applications</b>	Hygienic and washdown zones, Difficult application conditions
<b>Items supplied</b>	Mounting nut, V4A stainless steel (2x)

<sup>1)</sup> According to EN 60529.

### Mechanics/electronics

<b>Supply voltage</b>	10 V DC ... 30 V DC
<b>Ripple</b>	≤ 10 % <sup>1)</sup>
<b>Voltage drop</b>	≤ 2 V <sup>2)</sup>
<b>Time delay before availability</b>	≤ 300 ms
<b>Hysteresis</b>	1 % ... 20 %

<sup>1)</sup> Of  $V_S$ .

<sup>2)</sup> With I max.

<sup>3)</sup> Of  $S_r$ .

<b>Reproducibility</b>	≤ 2 % <sup>3)</sup>
<b>Temperature drift (of S<sub>r</sub>)</b>	≤ 10 %
<b>EMC</b>	According to EN 60947-5-2
<b>Continuous current I<sub>a</sub></b>	≤ 200 mA
<b>No load current</b>	≤ 10 mA
<b>Cable material</b>	PUR
<b>Conductor size</b>	0.34 mm <sup>2</sup>
<b>Cable diameter</b>	Ø 4.5 mm
<b>Short-circuit protection</b>	✓
<b>Power-up pulse protection</b>	✓
<b>Shock and vibration resistance</b>	100 g / 5 ms / 1000 cycles; 150 g / 1 Mio cycles; 10 Hz ... 55 Hz, 1 mm / 55 Hz ... 500 Hz / 60 g
<b>Ambient operating temperature</b>	-25 °C ... +75 °C
<b>Housing material</b>	Stainless steel V4A, DIN 1.4404 / AISI 316L
<b>Sensing face material</b>	Stainless steel V4A, DIN 1.4404 / AISI 316L
<b>Housing length</b>	60.3 mm
<b>Thread length</b>	55.8 mm
<b>Tightening torque, max.</b>	≤ 100 Nm
<b>Protection class</b>	III
<b>UL File No.</b>	E181493

<sup>1)</sup> Of V<sub>S</sub>.

<sup>2)</sup> With I max.

<sup>3)</sup> Of S<sub>r</sub>.

#### Safety-related parameters

<b>MTTF<sub>D</sub></b>	1,892 years
<b>DC<sub>avg</sub></b>	0 %

#### Reduction factors

<b>Note</b>	The values are reference values which may vary
<b>St37 steel (Fe)</b>	Approx. 1
<b>Stainless steel (V2A, 304)</b>	Approx. 0.52
<b>Aluminum (Al)</b>	Approx. 0.16
<b>Copper (Cu)</b>	Approx. 0
<b>Brass (Br)</b>	Approx. 0.22

#### Installation note

<b>Remark</b>	Associated graphic see "Installation"
<b>B</b>	25 mm
<b>C</b>	24 mm
<b>D</b>	20 mm
<b>F</b>	80 mm

#### Classifications

<b>ECLASS 5.0</b>	27270101
-------------------	----------

<b>ECLASS 5.1.4</b>	27270101
<b>ECLASS 6.0</b>	27270101
<b>ECLASS 6.2</b>	27270101
<b>ECLASS 7.0</b>	27270101
<b>ECLASS 8.0</b>	27270101
<b>ECLASS 8.1</b>	27270101
<b>ECLASS 9.0</b>	27270101
<b>ECLASS 10.0</b>	27270101
<b>ECLASS 11.0</b>	27270101
<b>ECLASS 12.0</b>	27274001
<b>ETIM 5.0</b>	EC002714
<b>ETIM 6.0</b>	EC002714
<b>ETIM 7.0</b>	EC002714
<b>ETIM 8.0</b>	EC002714
<b>UNSPSC 16.0901</b>	39122230

### Installation note

Flush installation

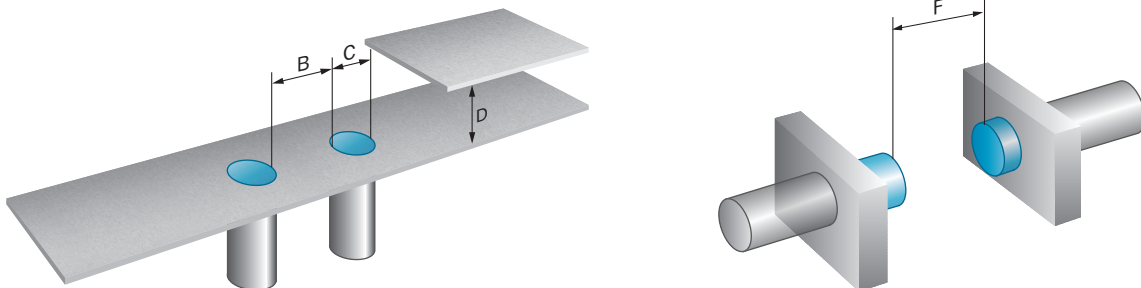

### Connection diagram

Cd-001

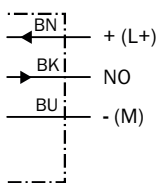

### Response diagram

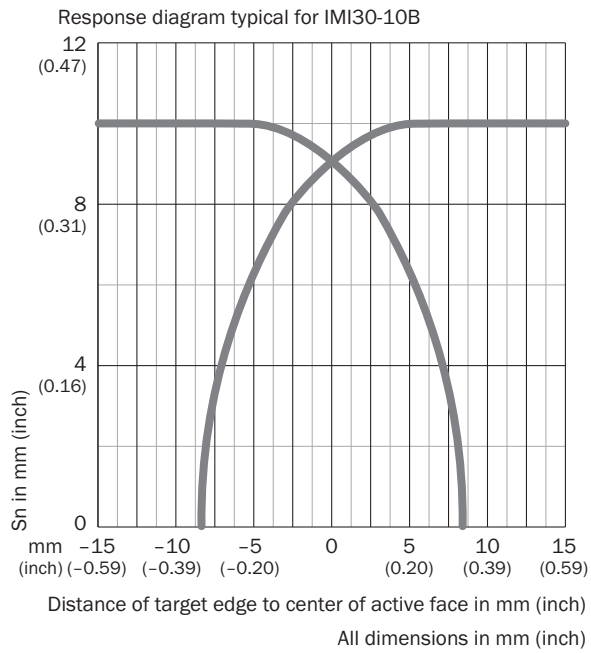



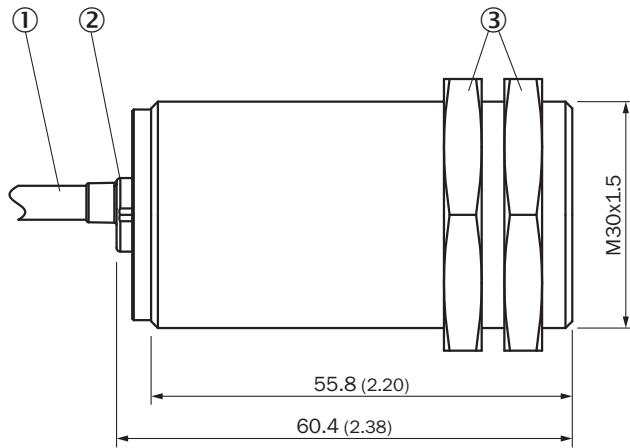

### Dimensional drawing (Dimensions in mm (inch))

IM30 Inox, flush



Recommended accessories

Other models and accessories → [www.sick.com/IMI](http://www.sick.com/IMI)

	Brief description	Type	Part no.
Others			
	<ul style="list-style-type: none"> <li>• <b>Connection type head A:</b> Male connector, M12, 4-pin, straight, A-coded</li> <li>• <b>Description:</b> Unshielded</li> <li>• <b>Connection systems:</b> Screw-type terminals</li> <li>• <b>Permitted cross-section:</b> ≤ 0.75 mm<sup>2</sup></li> <li>• <b>Application:</b> Hygienic and washdown zones</li> </ul>	STE-1204-GN	6028359
	<ul style="list-style-type: none"> <li>• <b>Connection type head A:</b> Male connector, M12, 4-pin, straight, A-coded</li> <li>• <b>Description:</b> Unshielded</li> <li>• <b>Connection systems:</b> Screw-type terminals</li> <li>• <b>Permitted cross-section:</b> ≤ 0.75 mm<sup>2</sup></li> <li>• <b>Note:</b> For 2 cable connections</li> <li>• <b>Application:</b> Hygienic and washdown zones</li> </ul>	STE-1204-TN	6028360
	<ul style="list-style-type: none"> <li>• <b>Connection type head A:</b> Female connector, M12, 4-pin, straight, A-coded</li> <li>• <b>Description:</b> Unshielded</li> <li>• <b>Connection systems:</b> Screw-type terminals</li> <li>• <b>Permitted cross-section:</b> ≤ 0.75 mm<sup>2</sup></li> <li>• <b>Application:</b> Hygienic and washdown zones</li> </ul>	DOS-1204-GN	6028357
	<ul style="list-style-type: none"> <li>• <b>Connection type head A:</b> Female connector, M12, 4-pin, angled, A-coded</li> <li>• <b>Description:</b> Unshielded</li> <li>• <b>Connection systems:</b> Screw-type terminals</li> <li>• <b>Permitted cross-section:</b> ≤ 0.75 mm<sup>2</sup></li> <li>• <b>Application:</b> Hygienic and washdown zones</li> </ul>	DOS-1204-WN	6028358

## SICK AT A GLANCE

SICK is one of the leading manufacturers of intelligent sensors and sensor solutions for industrial applications. A unique range of products and services creates the perfect basis for controlling processes securely and efficiently, protecting individuals from accidents and preventing damage to the environment.

We have extensive experience in a wide range of industries and understand their processes and requirements. With intelligent sensors, we can deliver exactly what our customers need. In application centers in Europe, Asia and North America, system solutions are tested and optimized in accordance with customer specifications. All this makes us a reliable supplier and development partner.

Comprehensive services complete our offering: SICK LifeTime Services provide support throughout the machine life cycle and ensure safety and productivity.

For us, that is “Sensor Intelligence.”

## WORLDWIDE PRESENCE:

Contacts and other locations –[www.sick.com](http://www.sick.com)