

SPZ-1E4-AD-D

Collets

SHAFT ADAPTATION

SICK
Sensor Intelligence.



Ordering information

Type	Part no.
SPZ-1E4-AD-D	2029193

Other models and accessories → www.sick.com/Collets

Detailed technical data

Classifications

ECLASS 5.0	21020701
ECLASS 5.1.4	21020701
ECLASS 6.0	21022190
ECLASS 6.2	21022190
ECLASS 7.0	21041712
ECLASS 8.0	21041712
ECLASS 8.1	21041712
ECLASS 9.0	21041712
ECLASS 10.0	21041712
ECLASS 11.0	21041712
ECLASS 12.0	21041712
ETIM 5.0	EC002384
ETIM 6.0	EC002384
ETIM 7.0	EC002384
ETIM 8.0	EC002384
UNSPSC 16.0901	27112104

Features

Description	Collet for through hollow shaft, shaft diameter 1/4" (6.35 mm), outer diameter 14 mm
Diameter	14 mm

Dimensional drawing (Dimensions in mm (inch))

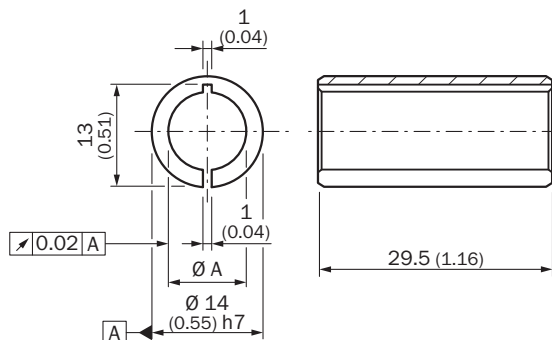

SICK AT A GLANCE

SICK is one of the leading manufacturers of intelligent sensors and sensor solutions for industrial applications. A unique range of products and services creates the perfect basis for controlling processes securely and efficiently, protecting individuals from accidents and preventing damage to the environment.

We have extensive experience in a wide range of industries and understand their processes and requirements. With intelligent sensors, we can deliver exactly what our customers need. In application centers in Europe, Asia and North America, system solutions are tested and optimized in accordance with customer specifications. All this makes us a reliable supplier and development partner.

Comprehensive services complete our offering: SICK LifeTime Services provide support throughout the machine life cycle and ensure safety and productivity.

For us, that is “Sensor Intelligence.”

WORLDWIDE PRESENCE:

Contacts and other locations –www.sick.com