



MAG-O-174-10

Position magnets

MAGNETS

SICK
Sensor Intelligence.



Ordering information

Type	Part no.
MAG-O-174-10	2115045

Other models and accessories → www.sick.com/Position_magnets

Detailed technical data

Classifications

ECLASS 5.0	27279209
ECLASS 5.1.4	27279209
ECLASS 6.0	27279209
ECLASS 6.2	27279209
ECLASS 7.0	27279209
ECLASS 8.0	27279209
ECLASS 8.1	27279209
ECLASS 9.0	27272492
ECLASS 10.0	27272492
ECLASS 11.0	27272492
ECLASS 12.0	27274392
ETIM 5.0	EC002594
ETIM 6.0	EC002594
ETIM 7.0	EC002594
ETIM 8.0	EC002594
UNSPSC 16.0901	39122245

Features

Description	Position magnet for magnetostrictive linear encoders ¹ . Installation: in hydraulic cylinder using corrugated spring washer SICK part no. 2116431 ² . Temperature range: -30 °C ... +95 °C ³ . Dimensions: 17.4x12x10.6 mm ⁴ . Media: lubricants, hydraulic oils, no aggressive fluids (e.g., acids or bases)
Items supplied	10 pieces
Packing unit	10 pieces
Diameter	17.4 mm
Housing color	Black

Dimensional drawing (Dimensions in mm (inch))

Position magnet

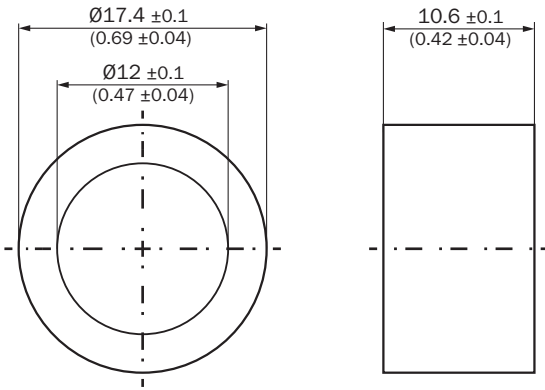

SICK AT A GLANCE

SICK is one of the leading manufacturers of intelligent sensors and sensor solutions for industrial applications. A unique range of products and services creates the perfect basis for controlling processes securely and efficiently, protecting individuals from accidents and preventing damage to the environment.

We have extensive experience in a wide range of industries and understand their processes and requirements. With intelligent sensors, we can deliver exactly what our customers need. In application centers in Europe, Asia and North America, system solutions are tested and optimized in accordance with customer specifications. All this makes us a reliable supplier and development partner.

Comprehensive services complete our offering: SICK LifeTime Services provide support throughout the machine life cycle and ensure safety and productivity.

For us, that is “Sensor Intelligence.”

WORLDWIDE PRESENCE:

Contacts and other locations –www.sick.com