



WSE9-3P2430

W9

SMALL PHOTOELECTRIC SENSORS

SICK
Sensor Intelligence.



Illustration may differ



Ordering information

Type	Part no.
WSE9-3P2430	1049077

Other models and accessories → www.sick.com/W9

Detailed technical data

Features

Functional principle	Through-beam photoelectric sensor
Dimensions (W x H x D)	12.2 mm x 52.2 mm x 23.6 mm
Housing design (light emission)	Rectangular
Mounting hole	M3
Sensing range max.	0 m ... 10 m
Sensing range	0 m ... 7 m
Type of light	Visible red light
Light source	PinPoint LED ¹⁾
Light spot size (distance)	Ø 25 mm (1 m)
Wave length	650 nm
Adjustment	None

¹⁾ Average service life: 100,000 h at T_J = +25 °C.

Mechanics/electronics

Supply voltage U_B	10 V DC ... 30 V DC ¹⁾
Ripple	< 5 V _{pp} ²⁾
Current consumption	30 mA ³⁾
Switching output	PNP ⁴⁾
Switching mode	Light/dark switching ⁴⁾
Output current I_{max}	≤ 100 mA ⁵⁾
Response time	< 0.5 ms ⁶⁾
Switching frequency	1,000 Hz ⁷⁾
Connection type	Male connector M12, 4-pin
Circuit protection	A ⁸⁾ B ⁹⁾ C ¹⁰⁾
Protection class	III
Weight	13 g
Housing material	Plastic, VISTAL®
Optics material	Plastic, PMMA
Enclosure rating	IP66 IP67 IP69K
Test input sender off	Sender off
Ambient operating temperature	-40 °C ... +60 °C
Ambient temperature, storage	-40 °C ... +75 °C
UL File No.	NRKH.E181493
Part number of individual components	2055824 WS9-3D2430 2055825 WE9-3P2430

¹⁾ Limit values when operated in short-circuit protected network: max. 8 A.

²⁾ May not fall below or exceed U_V tolerances.

³⁾ Without load.

⁴⁾ Q = light switching.

⁵⁾ At and above T_u 50 °C, a max. load current of $I_{max} = 50$ mA is permitted.

⁶⁾ Signal transit time with resistive load.

⁷⁾ With light/dark ratio 1:1.

⁸⁾ A = V_S connections reverse-polarity protected.

⁹⁾ B = inputs and output reverse-polarity protected.

¹⁰⁾ C = interference suppression.

Safety-related parameters

MTTF_D	968 years
DC_{avg}	0 %
T_M (mission time)	20 years

Classifications

ECLASS 5.0	27270901
ECLASS 5.1.4	27270901
ECLASS 6.0	27270901

ECLASS 6.2	27270901
ECLASS 7.0	27270901
ECLASS 8.0	27270901
ECLASS 8.1	27270901
ECLASS 9.0	27270901
ECLASS 10.0	27270901
ECLASS 11.0	27270901
ECLASS 12.0	27270901
ETIM 5.0	EC002716
ETIM 6.0	EC002716
ETIM 7.0	EC002716
ETIM 8.0	EC002716
UNSPSC 16.0901	39121528

Adjustments

No adjustment possibility

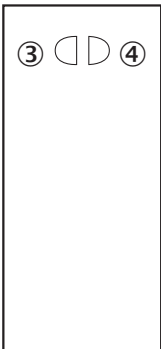

- ③ LED indicator yellow: Status of received light beam
- ④ LED indicator green: power on

Connection type

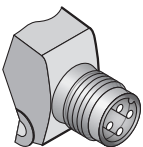

Connection diagram

Cd-072

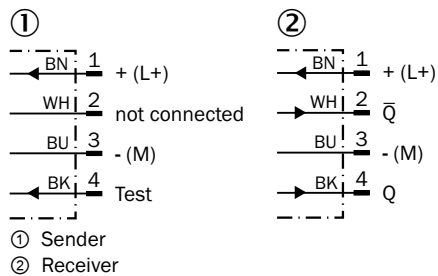

Characteristic curve

WSE9-3, red light, 10 m

Operating reserve

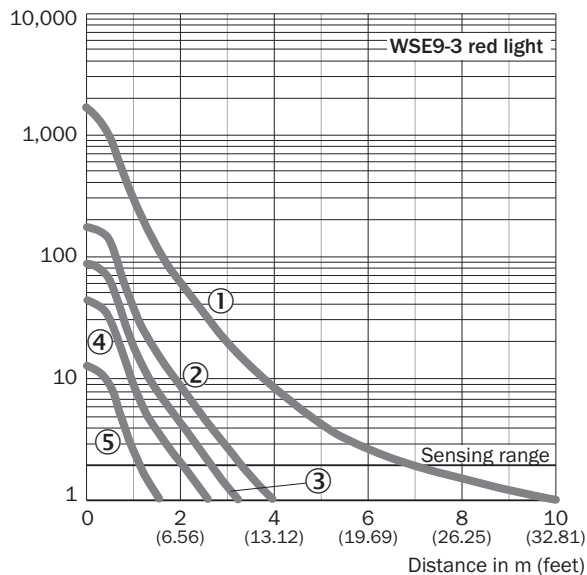

- ① Without masks
- ② With slotted mask, width 2.0 mm
- ③ With slotted mask, width 1.5 mm
- ④ With slotted mask, width 1.0 mm
- ⑤ With slotted mask, width 0.5 mm

Light spot size

WSE9-3, red light, 10 m

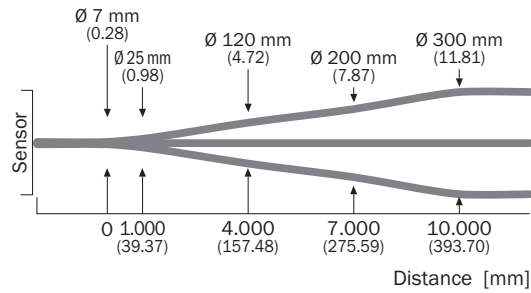

Sensing range diagram

WSE9-3, red light, 10 m

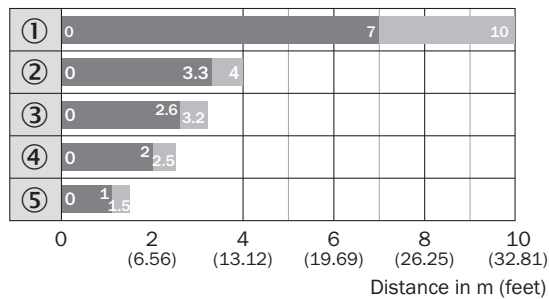

- Sensing range
- Sensing range, max. typ.
- ① Without masks
- ② With slotted mask, width 2.0 mm
- ③ With slotted mask, width 1.5 mm
- ④ With slotted mask, width 1.0 mm
- ⑤ With slotted mask, width 0.5 mm

Dimensional drawing (Dimensions in mm (inch))

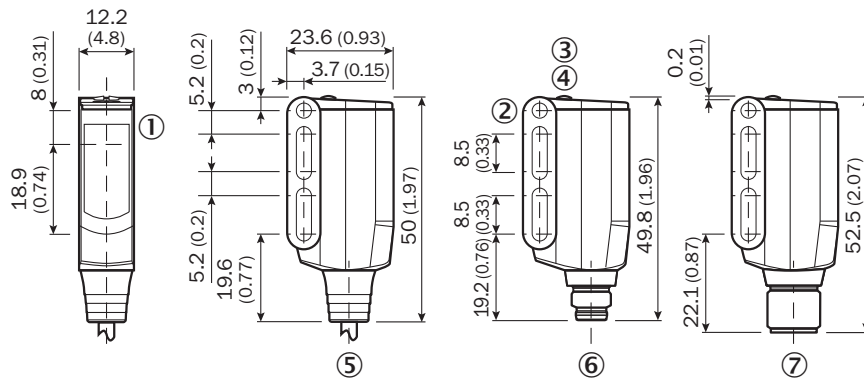

WL9-3, WSE9-3



- ① Sender and receiver optical axis center
- ② Mounting hole M3 (Ø 3.1 mm)
- ③ LED indicator yellow: Status of received light beam
- ④ LED indicator green: power on
- ⑤ Connecting cable or connector
- ⑥ Male connector M8, 4-pin
- ⑦ Male connector M12, 4-pin

Recommended accessories

Other models and accessories → www.sick.com/W9

	Brief description	Type	Part no.
Mounting brackets and plates			
	Mounting bracket, steel, zinc coated, mounting hardware included	BEF-WN-W9-2	2022855
Others			
	<ul style="list-style-type: none"> • Connection type head A: Female connector, M12, 4-pin, straight, A-coded • Connection type head B: Flying leads • Signal type: Sensor/actuator cable • Cable: 5 m, 4-wire, PVC • Description: Sensor/actuator cable, unshielded • Application: Zones with chemicals 	YF2A14-050VB3XLEAX	2096235
	<ul style="list-style-type: none"> • Connection type head A: Male connector, M12, 4-pin, straight, A-coded • Description: Unshielded • Connection systems: Screw-type terminals • Permitted cross-section: ≤ 0.75 mm² 	STE-1204-G	6009932

SICK AT A GLANCE

SICK is one of the leading manufacturers of intelligent sensors and sensor solutions for industrial applications. A unique range of products and services creates the perfect basis for controlling processes securely and efficiently, protecting individuals from accidents and preventing damage to the environment.

We have extensive experience in a wide range of industries and understand their processes and requirements. With intelligent sensors, we can deliver exactly what our customers need. In application centers in Europe, Asia and North America, system solutions are tested and optimized in accordance with customer specifications. All this makes us a reliable supplier and development partner.

Comprehensive services complete our offering: SICK LifeTime Services provide support throughout the machine life cycle and ensure safety and productivity.

For us, that is “Sensor Intelligence.”

WORLDWIDE PRESENCE:

Contacts and other locations –www.sick.com