



# IM12-10NNS-ZW1

IML

**INDUCTIVE PROXIMITY SENSORS**

**SICK**  
Sensor Intelligence.



## Ordering information

Type	Part no.
IM12-10NNS-ZW1	6027513

Other models and accessories → [www.sick.com/IML](http://www.sick.com/IML)

Illustration may differ



## Detailed technical data

### Features

<b>Housing</b>	Metric
<b>Housing</b>	Standard design
<b>Thread size</b>	M12 x 1
<b>Diameter</b>	Ø 12 mm
<b>Sensing range <math>S_n</math></b>	10 mm
<b>Safe sensing range <math>S_a</math></b>	8.1 mm
<b>Installation type</b>	Non-flush
<b>Switching frequency</b>	400 Hz
<b>Connection type</b>	Cable, 3-wire, 2 m
<b>Switching output</b>	NPN
<b>Output function</b>	NO
<b>Electrical wiring</b>	DC 3-wire
<b>Enclosure rating</b>	IP67 <sup>1)</sup>
<b>Special features</b>	Triple sensing range
<b>Items supplied</b>	Mounting nut, brass, chromium-plated (2x) Washer, brass, chromium-plated, with locking teeth (2x)

<sup>1)</sup> According to EN 60529.

### Mechanics/electronics

<b>Supply voltage</b>	10 V DC ... 30 V DC
<b>Ripple</b>	≤ 10 % <sup>1)</sup>
<b>Voltage drop</b>	≤ 2 V <sup>2)</sup>

<sup>1)</sup> Of  $V_S$ .

<sup>2)</sup> At  $I_a$  max.

<sup>3)</sup> Of  $S_r$ .

<sup>4)</sup>  $U_B = 20 \text{ V DC} \dots 30 \text{ V DC}$ ,  $T_A = 23 \text{ °C} \pm 5 \text{ °C}$ .

<sup>5)</sup> LED lights continuously ( $0 \leq s \leq 0.8 \text{ Sr}$ ); LED flashing ( $0.8 \text{ Sr} < s \leq \text{Sr}$ ).

<b>Time delay before availability</b>	≤ 50 ms
<b>Hysteresis</b>	1 % ... 15 %
<b>Reproducibility</b>	≤ 5 % <sup>3) 4)</sup>
<b>Temperature drift (of S<sub>r</sub>)</b>	± 10 %
<b>EMC</b>	According to EN 60947-5-2
<b>Continuous current I<sub>a</sub></b>	≤ 200 mA
<b>Cable material</b>	PVC
<b>Conductor size</b>	0.34 mm <sup>2</sup>
<b>Cable diameter</b>	Ø 5 mm
<b>Short-circuit protection</b>	✓
<b>Power-up pulse protection</b>	✓
<b>Shock and vibration resistance</b>	30 g, 11 ms / 10 ... 55 Hz, 1 mm
<b>Installation aid</b>	✓ <sup>5)</sup>
<b>Ambient operating temperature</b>	-25 °C ... +70 °C
<b>Housing material</b>	Brass, chromium-plated
<b>Sensing face material</b>	Plastic, PTB
<b>Housing length</b>	52 mm
<b>Thread length</b>	44 mm
<b>Tightening torque, max.</b>	10 Nm

1) Of V<sub>S</sub>.

2) At I<sub>a</sub> max.

3) Of S<sub>r</sub>.

4) UB = 20 V DC ... 30 V DC, TA = 23 °C ± 5 °C.

5) LED lights continuously (0 ≤ s ≤ 0.8 Sr); LED flashing (0.8 Sr < s ≤ Sr).

### Safety-related parameters

<b>MTTF<sub>D</sub></b>	171 years
<b>DC<sub>avg</sub></b>	0%
<b>T<sub>M</sub> (mission time)</b>	20 years

### Reduction factors

<b>Note</b>	The values are reference values which may vary
<b>Stainless steel (V2A, 304)</b>	Approx. 0.77
<b>Aluminum (Al)</b>	Approx. 0.49
<b>Copper (Cu)</b>	Approx. 0.45
<b>Brass (Br)</b>	Approx. 0.56

### Installation note

<b>Remark</b>	Associated graphic see "Installation"
<b>A</b>	10 mm
<b>B</b>	30 mm
<b>C</b>	12 mm
<b>D</b>	30 mm
<b>E</b>	13 mm

<b>F</b>	100 mm
----------	--------

Classifications

<b>ECLASS 5.0</b>	27270101
<b>ECLASS 5.1.4</b>	27270101
<b>ECLASS 6.0</b>	27270101
<b>ECLASS 6.2</b>	27270101
<b>ECLASS 7.0</b>	27270101
<b>ECLASS 8.0</b>	27270101
<b>ECLASS 8.1</b>	27270101
<b>ECLASS 9.0</b>	27270101
<b>ECLASS 10.0</b>	27270101
<b>ECLASS 11.0</b>	27270101
<b>ECLASS 12.0</b>	27274001
<b>ETIM 5.0</b>	EC002714
<b>ETIM 6.0</b>	EC002714
<b>ETIM 7.0</b>	EC002714
<b>ETIM 8.0</b>	EC002714
<b>UNSPSC 16.0901</b>	39122230

Installation note

Non-flush installation

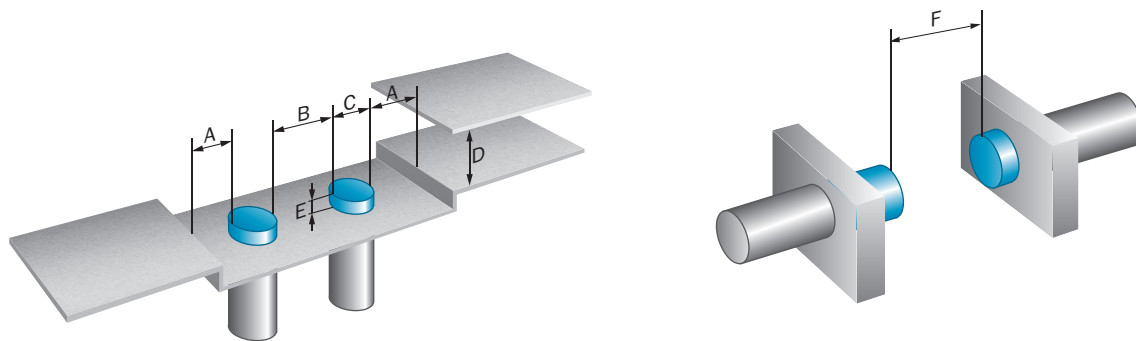

Connection type

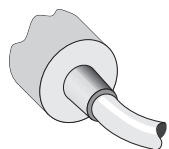

## Connection diagram

Cd-001



## Dimensional drawing (Dimensions in mm (inch))



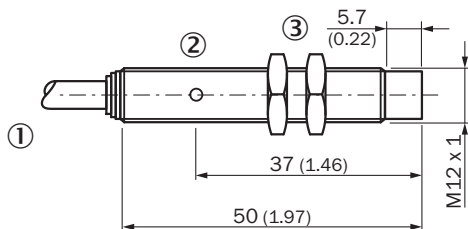

IM12 Triplex, cable, non-flush



- ① Connection
- ② Display LED
- ③ Fastening nuts (2x); width across 17, metal

## Recommended accessories

Other models and accessories → [www.sick.com/IML](http://www.sick.com/IML)

	Brief description	Type	Part no.
<b>Universal bar clamp systems</b>			
	Plate N05 for universal clamp bracket, M12, Zinc plated steel (sheet), Zinc die cast (clamping bracket), Universal clamp (5322626), mounting hardware	BEF-KHS-N05	2051611
<b>Mounting brackets and plates</b>			
	Mounting plate for M12 sensors, steel, zinc coated, without mounting hardware	BEF-WG-M12	5321869
	Mounting bracket for M12 sensors, steel, zinc coated, without mounting hardware	BEF-WN-M12	5308447
<b>Terminal and alignment brackets</b>			
	Clamping block for round sensors M12, with fixed stop, plastic (PA12), glass-fiber reinforced, mounting hardware included	BEF-KHF-M12	2051480

## SICK AT A GLANCE

SICK is one of the leading manufacturers of intelligent sensors and sensor solutions for industrial applications. A unique range of products and services creates the perfect basis for controlling processes securely and efficiently, protecting individuals from accidents and preventing damage to the environment.

We have extensive experience in a wide range of industries and understand their processes and requirements. With intelligent sensors, we can deliver exactly what our customers need. In application centers in Europe, Asia and North America, system solutions are tested and optimized in accordance with customer specifications. All this makes us a reliable supplier and development partner.

Comprehensive services complete our offering: SICK LifeTime Services provide support throughout the machine life cycle and ensure safety and productivity.

For us, that is “Sensor Intelligence.”

## WORLDWIDE PRESENCE:

Contacts and other locations –[www.sick.com](http://www.sick.com)