



**WTB27-3P1111S07**  
W27

**COMPACT PHOTOELECTRIC SENSORS**

**SICK**  
Sensor Intelligence.



Illustration may differ



## Ordering information

Type	Part no.
WTB27-3P1111S07	1028570

Other models and accessories → [www.sick.com/W27](http://www.sick.com/W27)

## Detailed technical data

### Features

<b>Functional principle</b>	Photoelectric proximity sensor
<b>Functional principle detail</b>	Background suppression
<b>Dimensions (W x H x D)</b>	24.6 mm x 79.5 mm x 43.3 mm
<b>Housing design (light emission)</b>	Rectangular
<b>Sensing range max.</b>	30 mm ... 1,400 mm <sup>1)</sup>
<b>Sensing range</b>	100 mm ... 1,400 mm
<b>Type of light</b>	Infrared light
<b>Light source</b>	LED <sup>2)</sup>
<b>Light spot size (distance)</b>	Ø 25 mm (800 mm)
<b>Wave length</b>	880 nm
<b>Adjustment</b>	Potentiometer
<b>Special features</b>	Reduced installation depth

<sup>1)</sup> Object with 90% remission (based on standard white, DIN 5033).

<sup>2)</sup> Average service life: 100,000 h at T<sub>J</sub> = +25 °C.

Mechanics/electronics

<b>Supply voltage <math>U_B</math></b>	10 V DC ... 30 V DC <sup>1)</sup>
<b>Ripple</b>	< 5 V <sub>pp</sub> <sup>2)</sup>
<b>Current consumption</b>	40 mA <sup>3)</sup>
<b>Switching output</b>	PNP
<b>Output function</b>	Complementary
<b>Switching mode</b>	Light/dark switching
<b>Signal voltage PNP HIGH/LOW</b>	Approx. $V_S - 2.5 \text{ V} / 0 \text{ V}$
<b>Output current <math>I_{\text{max}}</math></b>	≤ 100 mA
<b>Response time</b>	≤ 1.5 ms <sup>4)</sup>
<b>Switching frequency</b>	350 Hz <sup>5)</sup>
<b>Connection type</b>	Cable, 4-wire, 2 m <sup>6)</sup>
<b>Cable material</b>	Plastic, PVC
<b>Circuit protection</b>	A <sup>7)</sup> B <sup>8)</sup> C <sup>9)</sup>
<b>Protection class</b>	II <sup>10)</sup>
<b>Weight</b>	180 g
<b>Special device</b>	✓
<b>Housing material</b>	Plastic, ABS
<b>Optics material</b>	Plastic, PMMA
<b>Enclosure rating</b>	IP54
<b>Ambient operating temperature</b>	-40 °C ... +60 °C
<b>Ambient temperature, storage</b>	-40 °C ... +75 °C
<b>UL File No.</b>	NRKH.E181493 & NRKH7.E181493

- <sup>1)</sup> Limit values when operated in short-circuit protected network: max. 8 A.
- <sup>2)</sup> May not exceed or fall below  $U_V$  tolerances.
- <sup>3)</sup> Without load.
- <sup>4)</sup> Signal transit time with resistive load.
- <sup>5)</sup> With light/dark ratio 1:1.
- <sup>6)</sup> Do not bend below 0 °C.
- <sup>7)</sup> A =  $V_S$  connections reverse-polarity protected.
- <sup>8)</sup> B = inputs and output reverse-polarity protected.
- <sup>9)</sup> C = interference suppression.
- <sup>10)</sup> Reference voltage: 50 V DC.

Classifications

<b>ECLASS 5.0</b>	27270904
<b>ECLASS 5.1.4</b>	27270904
<b>ECLASS 6.0</b>	27270904
<b>ECLASS 6.2</b>	27270904
<b>ECLASS 7.0</b>	27270904
<b>ECLASS 8.0</b>	27270904
<b>ECLASS 8.1</b>	27270904

<b>ECLASS 9.0</b>	27270904
<b>ECLASS 10.0</b>	27270904
<b>ECLASS 11.0</b>	27270904
<b>ECLASS 12.0</b>	27270903
<b>ETIM 5.0</b>	EC002719
<b>ETIM 6.0</b>	EC002719
<b>ETIM 7.0</b>	EC002719
<b>ETIM 8.0</b>	EC002719
<b>UNSPSC 16.0901</b>	39121528

### Adjustments

Potentiometer

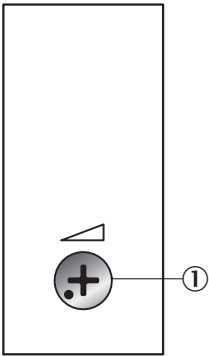

① Potentiometer

### Connection type

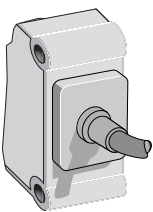

### Connection diagram

Cd-094

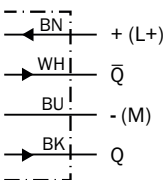

Characteristic curve

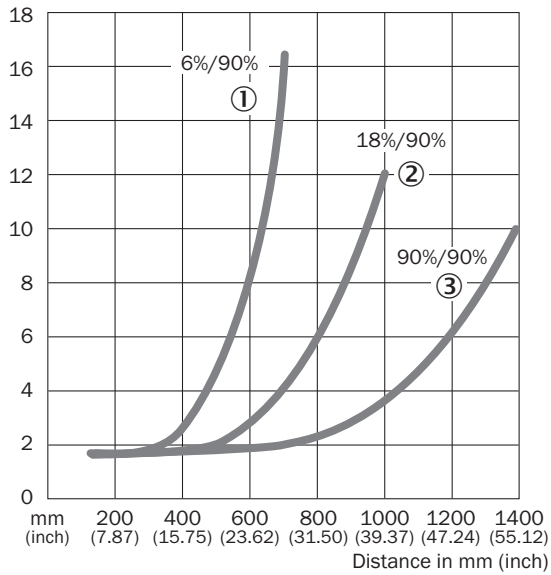

Sensing range diagram

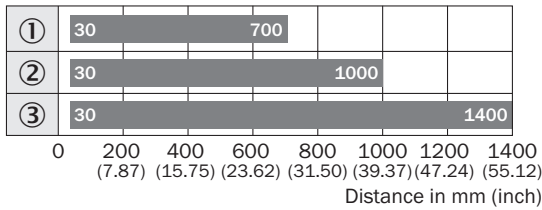

■ Sensing range

- ① Sensing range on black, 6 % remission
- ② Sensing range on gray, 18 % remission
- ③ Sensing range on white, 90 % remission

**Dimensional drawing** (Dimensions in mm (inch))

WTB27-3, potentiometer

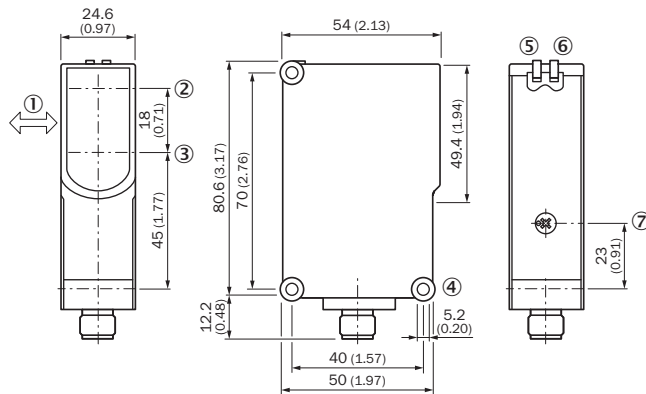

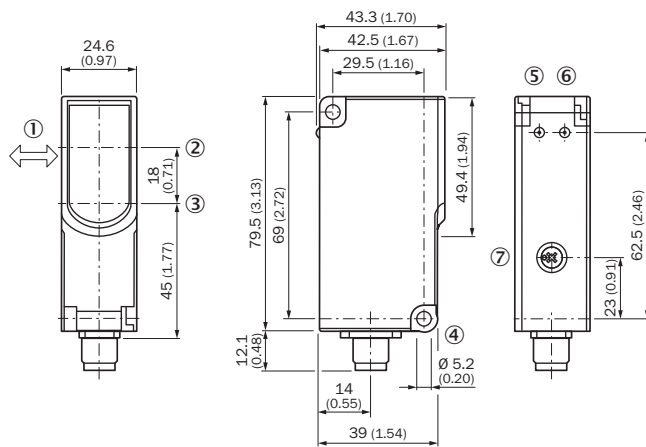

- ① Standard direction of the material being detected
- ② Optical axis, sender
- ③ Optical axis, receiver
- ④ Mounting hole  $\varnothing$  5.2 mm
- ⑤ LED indicator green: Supply voltage active
- ⑥ LED indicator yellow: Status of received light beam
- ⑦ Sensing range adjustment: potentiometer



- ① Standard direction of the material being detected
- ② Optical axis, sender
- ③ Optical axis, receiver
- ④ Mounting hole  $\varnothing$  5.2 mm
- ⑤ LED indicator green: Supply voltage active
- ⑥ LED indicator yellow: Status of received light beam
- ⑦ Sensing range adjustment: potentiometer
- ⑧ Time control
- ⑨ Time delay selector switch

## Recommended accessories

Other models and accessories → [www.sick.com/W27](http://www.sick.com/W27)

	Brief description	Type	Part no.
Device protection (mechanical)			
	Protective housing for W26, W27-3 and mounting rods with diameter 12 mm ... 20 mm, Zinc plated steel (protective housing), Zinc die cast (clamping bracket), Universal clamp BEF-KHS-KH1 (2022726), mounting hardware	BEF-SG-W27	2039601
Others			
	<ul style="list-style-type: none"> <li>• <b>Connection type head A:</b> Male connector, M12, 4-pin, straight, A-coded</li> <li>• <b>Description:</b> Unshielded</li> <li>• <b>Connection systems:</b> Screw-type terminals</li> <li>• <b>Permitted cross-section:</b> ≤ 0.75 mm<sup>2</sup></li> </ul>	STE-1204-G	6009932

## SICK AT A GLANCE

SICK is one of the leading manufacturers of intelligent sensors and sensor solutions for industrial applications. A unique range of products and services creates the perfect basis for controlling processes securely and efficiently, protecting individuals from accidents and preventing damage to the environment.

We have extensive experience in a wide range of industries and understand their processes and requirements. With intelligent sensors, we can deliver exactly what our customers need. In application centers in Europe, Asia and North America, system solutions are tested and optimized in accordance with customer specifications. All this makes us a reliable supplier and development partner.

Comprehensive services complete our offering: SICK LifeTime Services provide support throughout the machine life cycle and ensure safety and productivity.

For us, that is “Sensor Intelligence.”

## WORLDWIDE PRESENCE:

Contacts and other locations –[www.sick.com](http://www.sick.com)