



WL2000-R5310

W2000

COMPACT PHOTOELECTRIC SENSORS

SICK
Sensor Intelligence.



Illustration may differ



Ordering information

Type	Part no.
WL2000-R5310	7023054

Other models and accessories → www.sick.com/W2000

Detailed technical data

Features

Functional principle	Photoelectric retro-reflective sensor
Dimensions (W x H x D)	45 mm x 73.7 mm x 48.6 mm
Housing design (light emission)	Rectangular
Sensing range max.	0 m ... 15 m ¹⁾
Sensing range	0 m ... 15 m ¹⁾
Focus	Approx. 1.3°
Type of light	Visible red light
Light source	LED ²⁾
Light spot size (distance)	Ø 320 mm (14 m)
Angle of dispersion	Approx. 1.3°
Wave length	660 nm
Adjustment	Potentiometer

¹⁾ Reflector PL80A.

²⁾ Average service life: 100,000 h at T_J = +25 °C.

Mechanics/electronics

Supply voltage	24 V AC/DC ... 240 V AC/DC ¹⁾
Power consumption	≤ 6 W ²⁾
Switching output	Relay, electrically isolated
Output function	Change-over contacts
Switching mode	Light/dark switching
Switching mode selector	Selectable via light/dark selector
Switching current (switching voltage)	3 A (265 V)
Response time	≤ 10 ms ³⁾

¹⁾ Limit values.

²⁾ Without load.

³⁾ Signal transit time with resistive load.

⁴⁾ With light/dark ratio 1:1.

⁵⁾ Adjustable via Off delay selector switch.

⁶⁾ Reference voltage: 50 V DC.

Switching frequency	10 Hz ⁴⁾
Time functions	Off delay ⁵⁾
Delay time	≤ 0 s ≤ 1 s ≤ 5 s ≤ 10 s ≤ 14 s
Connection type	Mini connector, 5-pin
Protection class	II ⁶⁾
Weight	150 g
Polarisation filter	✓
Housing material	Plastic, Glassfibre reinforced plastic
Enclosure rating	IP67
Ambient operating temperature	-25 °C ... +40 °C
Ambient temperature, storage	-40 °C ... +70 °C
UL File No.	242366 & cUL No. NRKH7.E147756

- 1) Limit values.
- 2) Without load.
- 3) Signal transit time with resistive load.
- 4) With light/dark ratio 1:1.
- 5) Adjustable via Off delay selector switch.
- 6) Reference voltage: 50 V DC.

Classifications

eCl@ss 5.0	27270902
eCl@ss 5.1.4	27270902
eCl@ss 6.0	27270902
eCl@ss 6.2	27270902
eCl@ss 7.0	27270902
eCl@ss 8.0	27270902
eCl@ss 8.1	27270902
eCl@ss 9.0	27270902
eCl@ss 10.0	27270902
eCl@ss 11.0	27270902
eCl@ss 12.0	27270902
ETIM 5.0	EC002717
ETIM 6.0	EC002717
ETIM 7.0	EC002717
ETIM 8.0	EC002717
UNSPSC 16.0901	39121528

Connection type

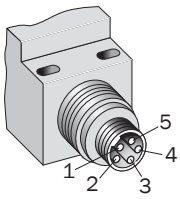

Connection diagram

Cd-171

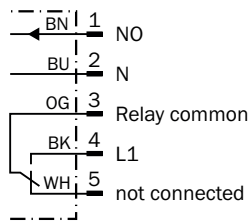

Characteristic curve

WL2000

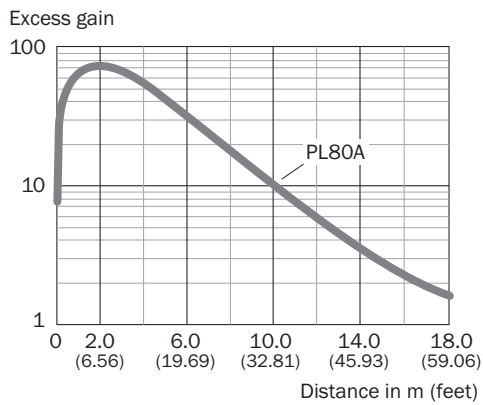

Sensing range diagram

WL2000

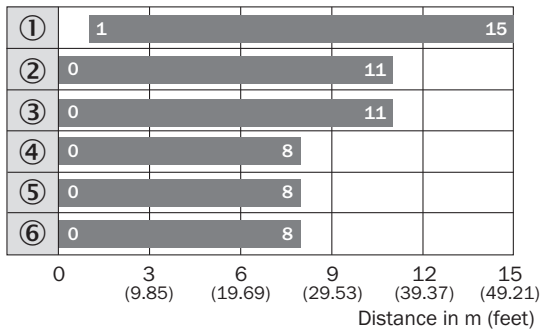

- Sensing range
- ① Reflector PL80A
- ② Reflector PL50A
- ③ Reflector PL40A
- ④ Reflector PL30A
- ⑤ Reflector PL20A
- ⑥ Reflective tape Diamond Grade

Dimensional drawing (Dimensions in mm (inch))

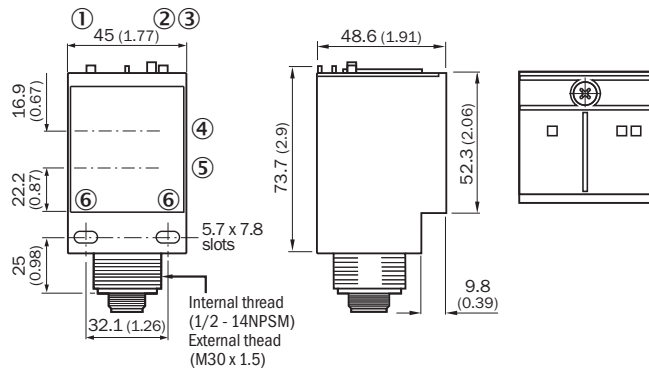

- ① LED indicator green: Supply voltage active
- ② Status indicator LED red: signal strength
- ③ Status indicator LED, yellow: Output active
- ④ Center of emitter optical axis
- ⑤ Center of receiver optical axis
- ⑥ Mounting hole \varnothing 0.2 mm x 0.8 mm

Recommended accessories

Other models and accessories → www.sick.com/W2000

	Brief description	Type	Part no.
Mounting brackets and plates			
	Universal mounting bracket for reflectors, steel, zinc coated	BEF-WN-REFX	2064574

	Brief description	Type	Part no.
Reflectors			
	Rectangular, screw connection, 51 mm x 61 mm, PMMA/ABS, Screw-on, 2 hole mounting	P250	5304812

SICK AT A GLANCE

SICK is one of the leading manufacturers of intelligent sensors and sensor solutions for industrial applications. A unique range of products and services creates the perfect basis for controlling processes securely and efficiently, protecting individuals from accidents and preventing damage to the environment.

We have extensive experience in a wide range of industries and understand their processes and requirements. With intelligent sensors, we can deliver exactly what our customers need. In application centers in Europe, Asia and North America, system solutions are tested and optimized in accordance with customer specifications. All this makes us a reliable supplier and development partner.

Comprehensive services complete our offering: SICK LifeTime Services provide support throughout the machine life cycle and ensure safety and productivity.

For us, that is “Sensor Intelligence.”

WORLDWIDE PRESENCE:

Contacts and other locations –www.sick.com