



# GLL170T-B432S01

GLL170

FIBER-OPTIC AMPLIFIER

**SICK**  
Sensor Intelligence.



Illustration may differ



### Ordering information

Type	Part no.
GLL170T-B432S01	6067015

Other models and accessories → [www.sick.com/GLL170](http://www.sick.com/GLL170)

### Detailed technical data

#### Features

<b>Device type</b>	Fiber-optic amplifier
<b>Device type detail</b>	Stand-alone
<b>Dimensions (W x H x D)</b>	10 mm x 31.7 mm x 72.5 mm
<b>Housing design (light emission)</b>	Rectangular
<b>Sensing range max.</b>	0 mm ... 400 mm (Proximity system) <sup>1) 2)</sup> 0 mm ... 1,320 mm (Through-beam system) <sup>3)</sup>
<b>Sensing range</b>	0 mm ... 350 mm, Proximity system <sup>1) 2)</sup> 0 mm ... 1,100 mm, Through-beam system <sup>3)</sup>
<b>Type of light</b>	Visible red light
<b>Light source</b>	LED <sup>4)</sup>
<b>Wave length</b>	632 nm
<b>Adjustment</b>	Teach-in button Cable Plus/minus button
<b>Indication</b>	7-segment
<b>Display</b>	Status LEDs, 4-digit digital display, display selectable between percentage value, absolute digit value and bar display / display of parameters
<b>Special features</b>	Output type preprogrammed to NPN

<sup>1)</sup> Object with 90% remission (based on standard white, DIN 5033).

<sup>2)</sup> LL3-DK06.

<sup>3)</sup> LL3-TB02.

<sup>4)</sup> Average service life: 100,000 h at T<sub>U</sub> = +25 °C.

## Mechanics/electronics

<b>Supply voltage <math>U_B</math></b>	10 V DC ... 30 V DC <sup>1)</sup>
<b>Ripple</b>	$\leq 10\%$ <sup>2)</sup>
<b>Current consumption</b>	40 mA <sup>3)</sup>
<b>Switching output</b>	PNP, NPN, Selectable via menu
<b>Number of switching outputs</b>	1
<b>Switching mode</b>	Light/dark switching
<b>Switching mode selector</b>	Selectable via menu
<b>Response time</b>	$\leq 250\ \mu\text{s}$ , $\leq 50\ \mu\text{s}$ , Selectable via menu <sup>4) 4)</sup>
<b>Switching frequency</b>	2 kHz, 10 kHz
<b>Time functions</b>	Switch-on delayoff delayone shotWithout time delay
<b>Delay time</b>	Programmable, 0 ms ... 9,999 ms
<b>Input</b>	Teach-in input
<b>Connection type</b>	Cable, 4-wire, 2 m <sup>5)</sup>
<b>Cable material</b>	Plastic, PVC
<b>Conductor cross section</b>	0.2 mm <sup>2</sup>
<b>Cable diameter</b>	$\varnothing 3.8\ \text{mm}$
<b>Circuit protection</b>	A <sup>6)</sup> B <sup>7)</sup> C <sup>8)</sup> D <sup>9)</sup>
<b>Protection class</b>	III
<b>Weight</b>	66 g
<b>Housing material</b>	Plastic, PC/POM
<b>Tightening torque, max.</b>	0.5 Nm
<b>Enclosure rating</b>	IP66 <sup>10)</sup>
<b>Ambient operating temperature</b>	-25 °C ... +55 °C
<b>Ambient temperature, storage</b>	-40 °C ... +70 °C
<b>UL File No.</b>	NRKH2.E300503 & NRKH8.E300503

<sup>1)</sup> Limit values.

<sup>2)</sup> May not fall below or exceed  $U_y$  tolerances.

<sup>3)</sup> Without load.

<sup>4)</sup> Signal transit time with resistive load.

<sup>5)</sup> Do not bend below 0 °C.

<sup>6)</sup> A =  $V_S$  connections reverse-polarity protected.

<sup>7)</sup> B = inputs and output reverse-polarity protected.

<sup>8)</sup> C = interference suppression.

<sup>9)</sup> D = outputs overcurrent and short-circuit protected.

<sup>10)</sup> With correctly attached fibre-optic cable LL3.

## Classifications

<b>ECLASS 5.0</b>	27270905
<b>ECLASS 5.1.4</b>	27270905
<b>ECLASS 6.0</b>	27270905

<b>ECLASS 6.2</b>	27270905
<b>ECLASS 7.0</b>	27270905
<b>ECLASS 8.0</b>	27270905
<b>ECLASS 8.1</b>	27270905
<b>ECLASS 9.0</b>	27270905
<b>ECLASS 10.0</b>	27270905
<b>ECLASS 11.0</b>	27270905
<b>ECLASS 12.0</b>	27270905
<b>ETIM 5.0</b>	EC002651
<b>ETIM 6.0</b>	EC002651
<b>ETIM 7.0</b>	EC002651
<b>ETIM 8.0</b>	EC002651
<b>UNSPSC 16.0901</b>	39121528

### Adjustments

GLL170T

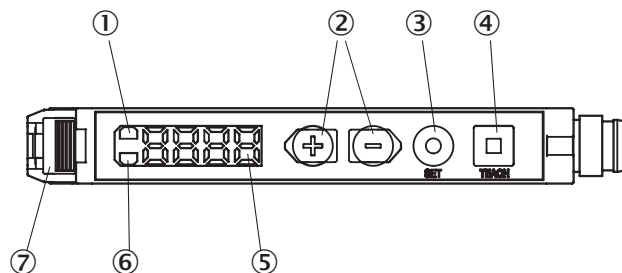

- ① LED indicator orange, lights up when switching output is active
- ② Plus/minus button
- ③ SET button
- ④ Teach-in button
- ⑤ Display
- ⑥ LED indicator green: Supply voltage active
- ⑦ Locking the fiber-optic cables

### Connection diagram

Cd-093

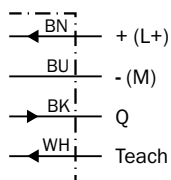



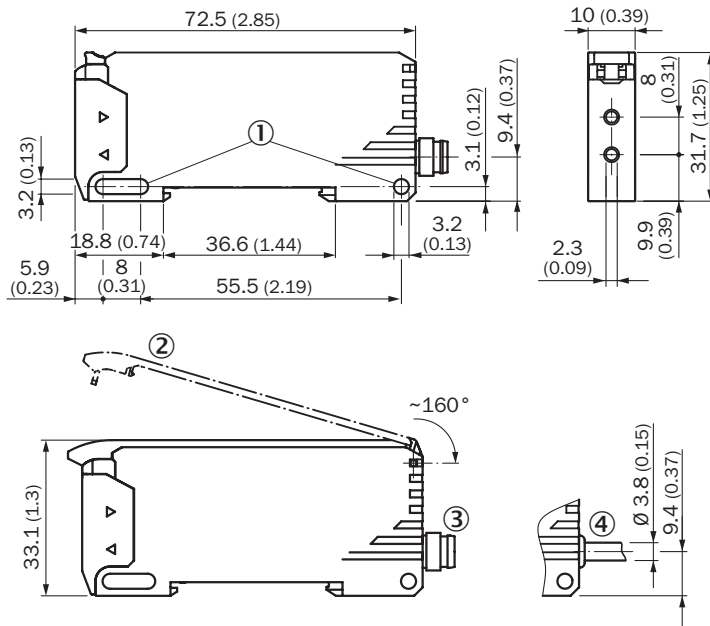

Dimensional drawing (Dimensions in mm (inch))



- ① Mounting holes
- ② Protective hood (optional), opens approx. 160°
- ③ Connector M8
- ④ Cable

Recommended accessories

Other models and accessories → [www.sick.com/GLL170](http://www.sick.com/GLL170)

	Brief description	Type	Part no.
Device protection (mechanical)			
	Protective Hood for GLL170, opens approx. 160°, PC	BF-GLL170	5336263
Mounting brackets and plates			
	Mounting bracket, steel, zinc coated, without mounting hardware	BEF-WLL180	5325812
Others			
	<ul style="list-style-type: none"> <li>• <b>Connection type head A:</b> Male connector, M8, 4-pin, straight, A-coded</li> <li>• <b>Description:</b> Unshielded</li> <li>• <b>Connection systems:</b> Screw-type terminals</li> <li>• <b>Permitted cross-section:</b> 0.14 mm² ... 0.5 mm²</li> </ul>	STE-0804-G	6037323
	<ul style="list-style-type: none"> <li>• <b>Connection type head A:</b> Female connector, M8, 4-pin, straight, A-coded</li> <li>• <b>Description:</b> Unshielded</li> <li>• <b>Connection systems:</b> Screw-type terminals</li> <li>• <b>Permitted cross-section:</b> 0.14 mm² ... 0.5 mm²</li> </ul>	DOS-0804-G	6009974
	<ul style="list-style-type: none"> <li>• <b>Connection type head A:</b> Female connector, M8, 4-pin, angled, A-coded</li> <li>• <b>Description:</b> Unshielded</li> <li>• <b>Connection systems:</b> Solder connection</li> <li>• <b>Permitted cross-section:</b> ≤ 0.25 mm²</li> </ul>	DOS-0804-W	6009975

	Brief description	Type	Part no.
Fibers			
	LL3-DB01	LL3-DB01	5308074
	LL3-DB02	LL3-DB02	5308083
	LL3-DC38	LL3-DC38	5322472
	LL3-DR11	LL3-DR11	5326000
	LL3-DT01	LL3-DT01	5308076
	LL3-DV05	LL3-DV05	5322549
	LL3-TB01	LL3-TB01	5308050
	LL3-TH08	LL3-TH08	5325978
	LL3-TS40	LL3-TS40	5323971
	LL3-TV05	LL3-TV05	5322546
	LL3-TX01	LL3-TX01	5324173
	LL3-TY01	LL3-TY01	5308066

## SICK AT A GLANCE

SICK is one of the leading manufacturers of intelligent sensors and sensor solutions for industrial applications. A unique range of products and services creates the perfect basis for controlling processes securely and efficiently, protecting individuals from accidents and preventing damage to the environment.

We have extensive experience in a wide range of industries and understand their processes and requirements. With intelligent sensors, we can deliver exactly what our customers need. In application centers in Europe, Asia and North America, system solutions are tested and optimized in accordance with customer specifications. All this makes us a reliable supplier and development partner.

Comprehensive services complete our offering: SICK LifeTime Services provide support throughout the machine life cycle and ensure safety and productivity.

For us, that is “Sensor Intelligence.”

## WORLDWIDE PRESENCE:

Contacts and other locations –[www.sick.com](http://www.sick.com)