

# MWS120-2AN1IF18X00

MWS120

MEASURING WHEEL ENCODERS

**SICK**  
Sensor Intelligence.

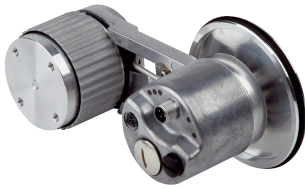

Illustration may differ

### Ordering information

Type	Part no.
MWS120-2AN1F18X00	1121564

**Included in delivery:** AFS60A-S4IB262144 (1), BEF-MR10300AK (1), BEF-MWS120-ARM (1)

Encoder and measuring wheel are attached to the measuring arm. See individual components for further technical data

Other models and accessories → [www.sick.com/MWS120](http://www.sick.com/MWS120)



### Detailed technical data

#### Safety-related parameters

<b>MTTF<sub>D</sub> (mean time to dangerous failure)</b>	80 years (EN ISO 13849-1) <sup>1) 2)</sup>
--	--

<sup>1)</sup> This product is a standard product and does not constitute a safety component as defined in the Machinery Directive. Calculation based on nominal load of components, average ambient temperature 40 °C, frequency of use 8760 h/a. All electronic failures are considered hazardous. For more information, see document no. 8015532.

<sup>2)</sup> Value refers to the mounted encoder.

#### Performance

<b>Number of steps per revolution (max. resolution)</b>	262,144 (18 bit)
<b>Measuring increment (resolution in mm/pulse)</b>	0.0008 <sup>1) 2)</sup>
<b>Repeatability</b>	< 0.1 mm <sup>3)</sup>

<sup>1)</sup> Calculation example: Circumference of wheel / pulses per revolution = 200 mm / 16384 pulses per revolution = 0,012mm/pulse.

<sup>2)</sup> Value based on measuring wheel circumference. The measuring wheel circumference depends on manufacturing tolerances, wear and tear, the selected spring tensioning force, and the behavior of the measurement wheel surface at different temperatures and on different measurement surfaces. To obtain the most accurate measurement results, we recommend performing a reference run for positioning tasks so that application-specific measuring wheel characteristics can be taken into account.

<sup>3)</sup> Value is based on the mechanics. Backlash of the measuring wheel mechanics, is at a minimum. This enables a precise and repeatable measurement results.

#### Interfaces

<b>Communication interface</b>	EtherNet/IP™
<b>Programmable/configurable</b>	✓

#### Electrical data

<b>Connection type</b>	Male connector, Female connector, 1x, 2x, M12, M12, 4-pin, 4-pin, axial, axial
<b>Power consumption</b>	≤ 3 W
<b>Supply voltage</b>	10 V DC ... 30 V DC
<b>Reverse polarity protection</b>	✓

## Mechanical data

<b>Measuring wheel circumference</b>	300 mm <sup>1)</sup>
<b>Measuring wheel surface</b>	Cross knurled aluminium
<b>Mounting</b>	Measuring wheel mounted at the rear
<b>Spring arm mechanism material</b>	
Spring element	Stainless steel
Measuring wheel, spring arm	Aluminum
<b>Start up torque</b>	0.5 Ncm
<b>Operating torque</b>	0.3 Ncm
<b>Bearing lifetime</b>	3.0 x 10 <sup>9</sup> revolutions
<b>Minimum spring tension force</b>	4 N <sup>2) 3)</sup>
<b>Max. permissible working area for the spring (continuous operation)</b>	± 10 mm
<b>Service life of spring element</b>	> 1.5 million cycles
<b>Mounting position relative to the measuring object</b>	Preferably from above, from below possible <sup>4)</sup>
<b>Mounted encoder</b>	AFS60 EtherNet/IP, AFS60A-S4IB262144, 1055364
<b>Mounted mechanic</b>	BEF-MWS120-ARM, 2118239
<b>Attached measuring wheel</b>	BEF-MR10300AK, 2115703

<sup>1)</sup> The surface of a measuring wheel is subject to wear. This depends on contact pressure, acceleration behavior in the application, traversing speed, measurement surface, mechanical alignment of the measuring wheel, temperature, and ambient conditions. We recommend you regularly check the condition of the measuring wheel and replace as required.

<sup>2)</sup> The right spring tension force for the application shall keep the slippage at a minimum in the application working conditions and measuring surface, without damaging the measuring surface.

<sup>3)</sup> The clamping force can be set in 6 fixed increments of 4 N. 4 N corresponds to one increment.

<sup>4)</sup> When mounted from below, the encoder weight during spring pretensioning must be taken into account.

## Ambient data

<b>EMC</b>	According to EN 61000-6-2 and EN 61000-6-3 <sup>1)</sup>
<b>Operating temperature range</b>	-30 °C ... +80 °C <sup>2)</sup>
<b>Storage temperature range</b>	-40 °C ... +100 °C <sup>2)</sup>

<sup>1)</sup> EMC according to the standards quoted is achieved if shielded cables are used.

<sup>2)</sup> This value reflects the smallest temperature value of the installed products. For more information, please look at the individual data sheets.

## Classifications

<b>ECLASS 5.0</b>	27270501
<b>ECLASS 5.1.4</b>	27270501
<b>ECLASS 6.0</b>	27270590
<b>ECLASS 6.2</b>	27270590
<b>ECLASS 7.0</b>	27270501
<b>ECLASS 8.0</b>	27270501
<b>ECLASS 8.1</b>	27270501
<b>ECLASS 9.0</b>	27270501
<b>ECLASS 10.0</b>	27270790
<b>ECLASS 11.0</b>	27270707

<b>ECLASS 12.0</b>	27270504
<b>ETIM 5.0</b>	EC001486
<b>ETIM 6.0</b>	EC001486
<b>ETIM 7.0</b>	EC001486
<b>ETIM 8.0</b>	EC001486
<b>UNSPSC 16.0901</b>	41112113

### Dimensional drawing (Dimensions in mm (inch))

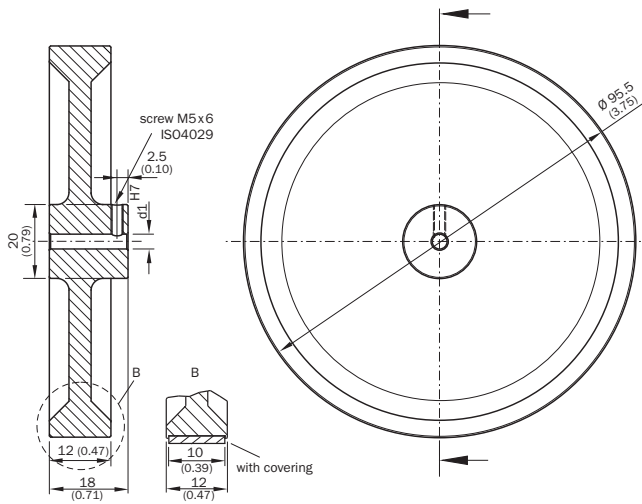

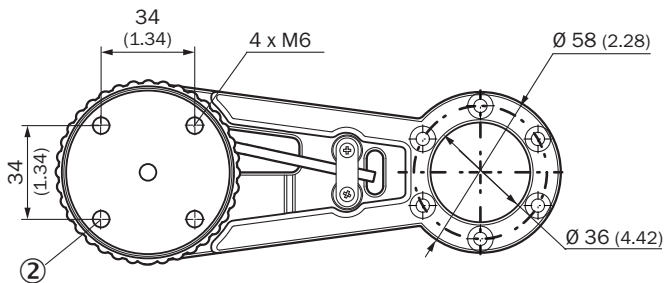
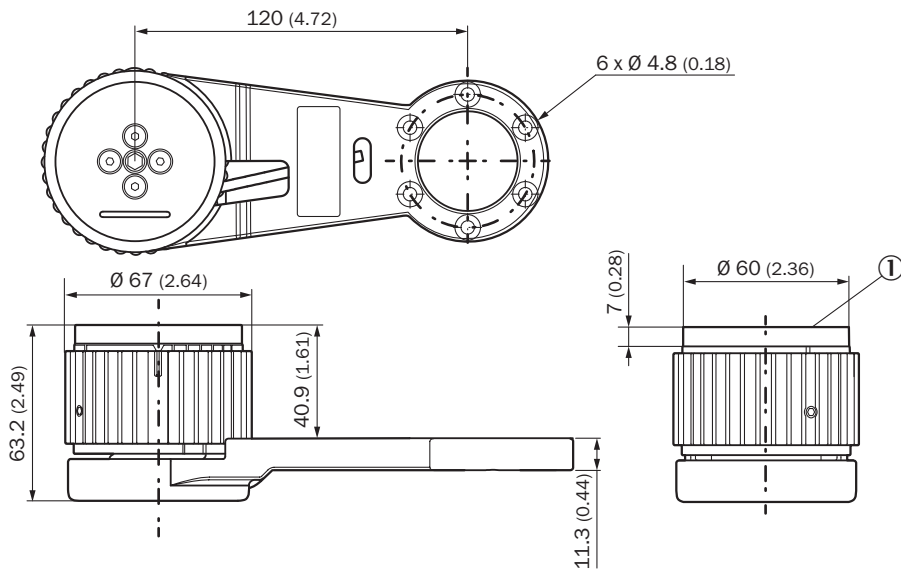

- ① Adapter plate
- ② Holes of the adapter plate, maximum thread depth 6 mm

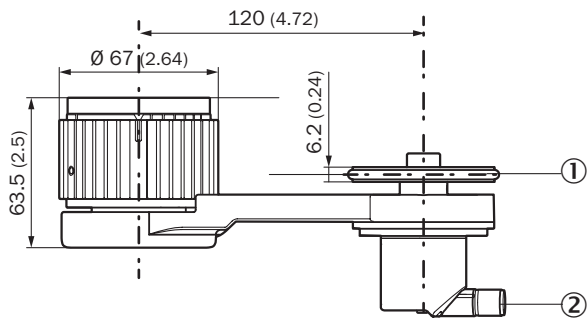

- ① The measuring wheel circumference and surface depend on the installed measuring wheel.
- ② Please refer to the dimensional drawings in the respective data sheet for the installed encoder.

### PIN assignment

Male connector

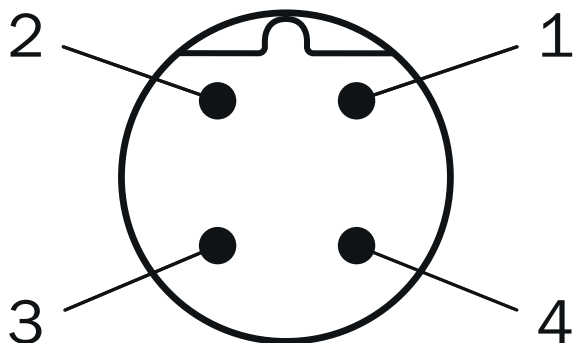

Supply voltage

PIN	Signal
1	10 V ... 30 V
2	Not assigned
3	GND
4	Not assigned

Female connector



Port 1, Port 2





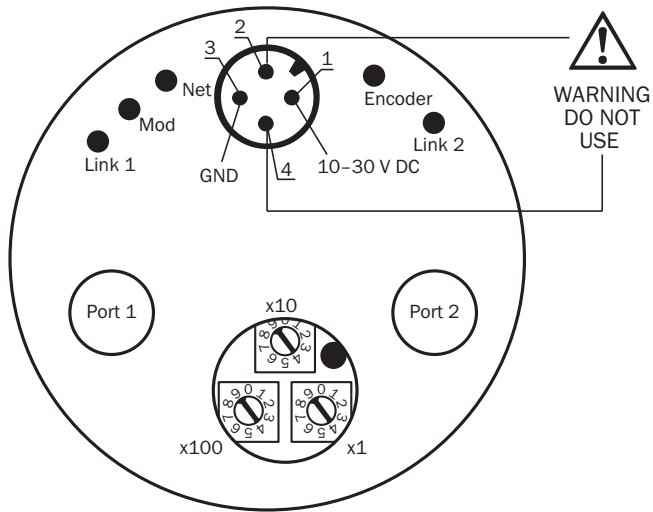

PIN	Signal
1	T x D+
2	R x D+
3	T x D-
4	R x D-

Connection diagram



Recommended accessories











Other models and accessories → [www.sick.com/MWS120](http://www.sick.com/MWS120)

	Brief description	Type	Part no.
<b>Mounting brackets and plates</b>			
	Mounting bracket for MWS120 measuring wheel system and SPEETEC 1D laser surface motion sensors	BEF-WF-MWS-NCV	2113284
<b>Other mounting accessories</b>			
	Aluminium measuring wheel with O-ring (NBR70) for 10 mm solid shaft, circumference 200 mm	BEF-MR010020R	2055224
	Aluminium measuring wheel with O-ring (NBR70) for 10 mm solid shaft, circumference 300 mm	BEF-MR010030R	2049278
	Measuring wheel with O-ring (NBR70) for 10 mm solid shaft, circumference 500 mm	BEF-MR010050R	2055227
	Aluminum measuring wheel with cross-knurled surface for 10 mm solid shaft, circumference 200 mm	BEF-MR10200AK	4084737
	Aluminum measuring wheel with smooth polyurethane surface for 10 mm solid shaft, circumference 200 mm	BEF-MR10200AP	4084738
	Aluminum measuring wheel with ridged polyurethane surface for 10 mm solid shaft, circumference 200 mm	BEF-MR10200APG	4084740
	Aluminum measuring wheel with studded polyurethane surface for 10 mm solid shaft, circumference 200 mm	BEF-MR10200APN	4084739
	Aluminum measuring wheel with cross-knurled surface for 10 mm solid shaft, circumference 300 mm	BEF-MR10300AK	2115703

	Brief description	Type	Part no.
	Aluminum measuring wheel with smooth polyurethane surface for 10 mm solid shaft, circumference 300 mm	BEF-MR10300AP	2118512
	Aluminum measuring wheel with ridged polyurethane surface for 10 mm solid shaft, circumference 300 mm	BEF-MR10300APG	2118496
	Aluminum measuring wheel with studded polyurethane surface for 10 mm solid shaft, circumference 300 mm	BEF-MR10300APN	2118494
	Aluminum measuring wheel with cross-knurled surface for 10 mm solid shaft, circumference 500 mm	BEF-MR10500AK	4084733
	Aluminum measuring wheel with smooth polyurethane surface for 10 mm solid shaft, circumference 500 mm	BEF-MR10500AP	4084734
	Aluminum measuring wheel with ridged polyurethane surface for 10 mm solid shaft, circumference 500 mm	BEF-MR10500APG	4084736
	Aluminum measuring wheel with studded polyurethane surface for 10 mm solid shaft, circumference 500 mm	BEF-MR10500APN	4084735
	Spring arm for linear measurement with contact, spring contact pressure manually adjustable without tools in 6 increments of 4 N from 0 ... 24 N, can be combined with separately available encoders and measuring wheels., MWS120 spring arm (part number: 2118239), 3 pcs. M4 x 16 cylinder head screws for adapter or encoder mounting	BEF-MWS120-ARM	2118239
<b>Others</b>			
	<ul style="list-style-type: none"> <li>• <b>Connection type head A:</b> Female connector, M12, 4-pin, angled, A-coded</li> <li>• <b>Description:</b> Unshielded, Head A: female connector, M12, 4-pin, angled, unshielded, for power supply, for cable diameter 3 mm ... 6.5 mm Head B: -</li> <li>• <b>Connection systems:</b> Screw-type terminals</li> <li>• <b>Permitted cross-section:</b> ≤ 0.75 mm<sup>2</sup></li> </ul>	DQS-1204-W	6007303
	<ul style="list-style-type: none"> <li>• <b>Connection type head A:</b> Male connector, M12, 4-pin, straight, D-coded</li> <li>• <b>Connection type head B:</b> Male connector, M12, 4-pin, straight, D-coded</li> <li>• <b>Signal type:</b> Ethernet</li> <li>• <b>Cable:</b> 5 m, 4-wire, CAT5, CAT5e, PUR, halogen-free</li> <li>• <b>Description:</b> Ethernet, shielded, 5 m cable, M12 male connector straight to M12 male connector straight</li> </ul>	SSL-1204-G05ME90	6045277
	<ul style="list-style-type: none"> <li>• <b>Connection type head A:</b> Male connector, M12, 4-pin, straight, D-coded</li> <li>• <b>Connection type head B:</b> Male connector, M12, 4-pin, straight, D-coded</li> <li>• <b>Signal type:</b> Ethernet</li> <li>• <b>Cable:</b> 10 m, 4-wire, CAT5, CAT5e, PUR, halogen-free</li> <li>• <b>Description:</b> Ethernet, shielded, 10 m cable, M12 male connector straight to M12 male connector straight</li> </ul>	SSL-1204-G10ME90	6045279
	<ul style="list-style-type: none"> <li>• <b>Connection type head A:</b> Male connector, M12, 4-pin, straight, D-coded</li> <li>• <b>Connection type head B:</b> Flying leads</li> <li>• <b>Signal type:</b> Ethernet</li> <li>• <b>Cable:</b> 2 m, 4-wire, CAT5, CAT5e, PUR, halogen-free</li> <li>• <b>Description:</b> Ethernet, shielded, M12 male connector D-coded straight to open end</li> </ul>	STL-1204-G02ME90	6045284
	<ul style="list-style-type: none"> <li>• <b>Connection type head A:</b> Male connector, M12, 4-pin, straight, D-coded</li> <li>• <b>Connection type head B:</b> Flying leads</li> <li>• <b>Signal type:</b> Ethernet</li> <li>• <b>Cable:</b> 5 m, 4-wire, CAT5, CAT5e, PUR, halogen-free</li> <li>• <b>Description:</b> Ethernet, shielded, M12 male connector D-coded straight to open end</li> </ul>	STL-1204-G05ME90	6045285



	Brief description	Type	Part no.
	<ul style="list-style-type: none"> <li>• <b>Connection type head A:</b> Male connector, M12, 4-pin, straight, D-coded</li> <li>• <b>Connection type head B:</b> Flying leads</li> <li>• <b>Signal type:</b> Ethernet</li> <li>• <b>Cable:</b> 10 m, 4-wire, CAT5, CAT5e, PUR, halogen-free</li> <li>• <b>Description:</b> Ethernet, shielded, M12 male connector D-coded straight to open end</li> </ul>	STL-1204-G10ME90	6045286
	<ul style="list-style-type: none"> <li>• <b>Connection type head A:</b> Male connector, M12, 4-pin, angled, D-coded</li> <li>• <b>Connection type head B:</b> Flying leads</li> <li>• <b>Signal type:</b> Ethernet</li> <li>• <b>Cable:</b> 2 m, 4-wire, CAT5, CAT5e, PUR, halogen-free</li> <li>• <b>Description:</b> Ethernet, shielded, M12 male connector D-coded angled to open end</li> </ul>	STL-1204-W02ME90	6047912
	<ul style="list-style-type: none"> <li>• <b>Connection type head A:</b> Female connector, M12, 4-pin, straight, D-coded</li> <li>• <b>Signal type:</b> Ethernet</li> <li>• <b>Cable:</b> CAT5, CAT5e</li> <li>• <b>Description:</b> Ethernet, shielded, Head A: female connector, M12, 4-pin, straight, D-coded, shielded, for cable diameter 4 mm ... 8 mm Head B: -</li> <li>• <b>Connection systems:</b> IDC quick connection</li> <li>• <b>Permitted cross-section:</b> 0.14 mm<sup>2</sup> ... 0.34 mm<sup>2</sup></li> </ul>	DOS-1204-GE	6048153
	<ul style="list-style-type: none"> <li>• <b>Connection type head A:</b> Female connector, M12, 4-pin, angled, D-coded</li> <li>• <b>Signal type:</b> Ethernet</li> <li>• <b>Cable:</b> CAT5, CAT5e</li> <li>• <b>Description:</b> Ethernet, shielded, Head A: female connector, M12, 4-pin, angled, D-coded, shielded, for cable diameter 4 mm ... 8 mm Head B: -</li> <li>• <b>Connection systems:</b> IDC quick connection</li> <li>• <b>Permitted cross-section:</b> 0.14 mm<sup>2</sup> ... 0.34 mm<sup>2</sup></li> </ul>	DOS-1204-WE	6048154
	<ul style="list-style-type: none"> <li>• <b>Connection type head A:</b> Male connector, M12, 4-pin, angled, D-coded</li> <li>• <b>Connection type head B:</b> Flying leads</li> <li>• <b>Signal type:</b> Ethernet</li> <li>• <b>Cable:</b> 10 m, 4-wire, CAT5, CAT5e, PUR, halogen-free</li> <li>• <b>Description:</b> Ethernet, shielded, M12 male connector D-coded angled to open end</li> </ul>	STL-1204-W10ME90	6047914
	<ul style="list-style-type: none"> <li>• <b>Connection type head A:</b> Male connector, M12, 4-pin, angled, D-coded</li> <li>• <b>Connection type head B:</b> Flying leads</li> <li>• <b>Signal type:</b> Ethernet</li> <li>• <b>Cable:</b> 25 m, 4-wire, CAT5, CAT5e, PUR, halogen-free</li> <li>• <b>Description:</b> Ethernet, shielded, M12 male connector D-coded angled to open end</li> </ul>	STL-1204-W25ME90	6047915
	<ul style="list-style-type: none"> <li>• <b>Connection type head A:</b> Male connector, M12, 4-pin, straight, D-coded</li> <li>• <b>Signal type:</b> Ethernet</li> <li>• <b>Cable:</b> CAT5, CAT5e</li> <li>• <b>Description:</b> Ethernet, shielded, Head A: male connector, M12, 4-pin, straight, D-coded, shielded, for cable diameter 4 mm ... 8 mm Head B: -</li> <li>• <b>Connection systems:</b> IDC quick connection</li> <li>• <b>Permitted cross-section:</b> 0.14 mm<sup>2</sup> ... 0.34 mm<sup>2</sup></li> </ul>	STE-1204-GE01	6048151
	<ul style="list-style-type: none"> <li>• <b>Connection type head A:</b> Male connector, M12, 4-pin, angled, D-coded</li> <li>• <b>Signal type:</b> Ethernet</li> <li>• <b>Cable:</b> CAT5, CAT5e</li> <li>• <b>Description:</b> Ethernet, shielded, Head A: male connector, M12, 4-pin, angled, D-coded, shielded, for cable diameter 4 mm ... 8 mm Head B: -</li> <li>• <b>Connection systems:</b> IDC quick connection</li> <li>• <b>Permitted cross-section:</b> 0.14 mm<sup>2</sup> ... 0.34 mm<sup>2</sup></li> </ul>	STE-1204-WE	6048152
	<ul style="list-style-type: none"> <li>• <b>Connection type head A:</b> Male connector, RJ45, 8-pin, straight</li> <li>• <b>Signal type:</b> Gigabit Ethernet</li> <li>• <b>Cable:</b> CAT6A</li> <li>• <b>Description:</b> Gigabit Ethernet, shielded, Head A: male connector, RJ45, 8-pin, straight, shielded, EtherNet/IP, for cable diameter 4.5 mm ... 8 mm Head B: -</li> <li>• <b>Connection systems:</b> IDC quick connection</li> <li>• <b>Permitted cross-section:</b> 4.5 mm<sup>2</sup> ... 8 mm<sup>2</sup></li> </ul>	STE-0J08-GE	6048150
	<ul style="list-style-type: none"> <li>• <b>Connection type head A:</b> Female connector, M12, 4-pin, D-coded</li> <li>• <b>Connection type head B:</b> Female connector, RJ45, 8-pin</li> <li>• <b>Signal type:</b> Ethernet</li> <li>• <b>Cable:</b> CAT5, CAT5e</li> <li>• <b>Description:</b> Ethernet, shielded</li> <li>• <b>Note:</b> Cabinet through</li> </ul>	Feedthrough female connector Ethernet RJ45	6048180

	Brief description	Type	Part no.
	<ul style="list-style-type: none"> <li><b>Connection type head A:</b> Female connector, M12, 4-pin, straight, A-coded</li> <li><b>Connection type head B:</b> Flying leads</li> <li><b>Signal type:</b> Sensor/actuator cable</li> <li><b>Cable:</b> 2 m, 4-wire, PUR, halogen-free</li> <li><b>Description:</b> Sensor/actuator cable, unshielded</li> <li><b>Application:</b> Zones with oils and lubricants, Drag chain operation, Robot</li> </ul>	YF2A14-020UB3XLEAX	2095607
	<ul style="list-style-type: none"> <li><b>Connection type head A:</b> Female connector, M12, 4-pin, straight, A-coded</li> <li><b>Connection type head B:</b> Flying leads</li> <li><b>Signal type:</b> Sensor/actuator cable</li> <li><b>Cable:</b> 5 m, 4-wire, PUR, halogen-free</li> <li><b>Description:</b> Sensor/actuator cable, unshielded</li> <li><b>Application:</b> Zones with oils and lubricants, Drag chain operation, Robot</li> </ul>	YF2A14-050UB3XLEAX	2095608
	<ul style="list-style-type: none"> <li><b>Connection type head A:</b> Female connector, M12, 4-pin, straight, A-coded</li> <li><b>Connection type head B:</b> Flying leads</li> <li><b>Signal type:</b> Sensor/actuator cable</li> <li><b>Cable:</b> 10 m, 4-wire, PUR, halogen-free</li> <li><b>Description:</b> Sensor/actuator cable, unshielded</li> <li><b>Application:</b> Zones with oils and lubricants, Drag chain operation, Robot</li> </ul>	YF2A14-100UB3XLEAX	2095609
	<ul style="list-style-type: none"> <li><b>Connection type head A:</b> Female connector, M12, 4-pin, straight, A-coded</li> <li><b>Connection type head B:</b> Flying leads</li> <li><b>Signal type:</b> Sensor/actuator cable</li> <li><b>Cable:</b> 25 m, 4-wire, PUR, halogen-free</li> <li><b>Description:</b> Sensor/actuator cable, unshielded</li> <li><b>Application:</b> Zones with oils and lubricants, Drag chain operation, Robot</li> </ul>	YF2A14-250UB3XLEAX	2095615
	<ul style="list-style-type: none"> <li><b>Connection type head A:</b> Female connector, M12, 4-pin, angled, A-coded</li> <li><b>Connection type head B:</b> Flying leads</li> <li><b>Signal type:</b> Sensor/actuator cable</li> <li><b>Cable:</b> 2 m, 4-wire, PUR, halogen-free</li> <li><b>Description:</b> Sensor/actuator cable, unshielded</li> <li><b>Application:</b> Zones with oils and lubricants, Drag chain operation, Robot</li> </ul>	YG2A14-020UB3XLEAX	2095766
	<ul style="list-style-type: none"> <li><b>Connection type head A:</b> Female connector, M12, 4-pin, angled, A-coded</li> <li><b>Connection type head B:</b> Flying leads</li> <li><b>Signal type:</b> Sensor/actuator cable</li> <li><b>Cable:</b> 5 m, 4-wire, PUR, halogen-free</li> <li><b>Description:</b> Sensor/actuator cable, unshielded</li> <li><b>Application:</b> Zones with oils and lubricants, Drag chain operation, Robot</li> </ul>	YG2A14-050UB3XLEAX	2095767
	<ul style="list-style-type: none"> <li><b>Connection type head A:</b> Female connector, M12, 4-pin, angled, A-coded</li> <li><b>Connection type head B:</b> Flying leads</li> <li><b>Signal type:</b> Sensor/actuator cable</li> <li><b>Cable:</b> 10 m, 4-wire, PUR, halogen-free</li> <li><b>Description:</b> Sensor/actuator cable, unshielded</li> <li><b>Application:</b> Zones with oils and lubricants, Drag chain operation, Robot</li> </ul>	YG2A14-100UB3XLEAX	2095768
	<ul style="list-style-type: none"> <li><b>Connection type head A:</b> Female connector, M12, 4-pin, angled, A-coded</li> <li><b>Connection type head B:</b> Flying leads</li> <li><b>Signal type:</b> Sensor/actuator cable</li> <li><b>Cable:</b> 25 m, 4-wire, PUR, halogen-free</li> <li><b>Description:</b> Sensor/actuator cable, unshielded</li> <li><b>Application:</b> Zones with oils and lubricants, Drag chain operation, Robot</li> </ul>	YG2A14-250UB3XLEAX	2095771
	<ul style="list-style-type: none"> <li><b>Connection type head A:</b> Male connector, M12, 4-pin, angled, D-coded</li> <li><b>Connection type head B:</b> Male connector, M12, 4-pin, angled, D-coded</li> <li><b>Signal type:</b> Ethernet, PROFINET</li> <li><b>Cable:</b> 2 m, 4-wire, PUR, halogen-free</li> <li><b>Description:</b> Ethernet, PROFINET, shielded</li> <li><b>Application:</b> Drag chain operation, Zones with oils and lubricants</li> </ul>	YN2D24-020PN1N2D24	2106168
	<ul style="list-style-type: none"> <li><b>Connection type head A:</b> Male connector, M12, 4-pin, straight, D-coded</li> <li><b>Connection type head B:</b> Male connector, M12, 4-pin, straight, D-coded</li> <li><b>Signal type:</b> Ethernet, PROFINET</li> <li><b>Cable:</b> 2 m, 4-wire, PUR, halogen-free</li> <li><b>Description:</b> Ethernet, PROFINET, shielded</li> <li><b>Application:</b> Drag chain operation, Zones with oils and lubricants</li> </ul>	YM2D24-020PN1M2D24	2106159

	Brief description	Type	Part no.
	<ul style="list-style-type: none"> <li><b>Connection type head A:</b> Male connector, M12, 4-pin, angled, D-coded</li> <li><b>Connection type head B:</b> Male connector, RJ45, 4-pin, straight</li> <li><b>Signal type:</b> Ethernet, PROFINET</li> <li><b>Cable:</b> 2 m, 4-wire, PUR, halogen-free</li> <li><b>Description:</b> Ethernet, PROFINET, shielded</li> <li><b>Application:</b> Drag chain operation, Zones with oils and lubricants</li> </ul>	YN2D24-020PN1MRJA4	2106162
	<ul style="list-style-type: none"> <li><b>Connection type head A:</b> Male connector, M12, 4-pin, straight, D-coded</li> <li><b>Connection type head B:</b> Male connector, RJ45, 4-pin, straight</li> <li><b>Signal type:</b> Ethernet, PROFINET</li> <li><b>Cable:</b> 10 m, 4-wire, PUR, halogen-free</li> <li><b>Description:</b> Ethernet, PROFINET, shielded</li> <li><b>Application:</b> Drag chain operation, Zones with oils and lubricants</li> </ul>	YM2D24-100PN1MRJA4	2106185
	<ul style="list-style-type: none"> <li><b>Connection type head A:</b> Male connector, M12, 4-pin, straight, D-coded</li> <li><b>Connection type head B:</b> Male connector, RJ45, 4-pin, straight</li> <li><b>Signal type:</b> Ethernet, PROFINET</li> <li><b>Cable:</b> 5 m, 4-wire, PUR, halogen-free</li> <li><b>Description:</b> Ethernet, PROFINET, shielded</li> <li><b>Application:</b> Drag chain operation, Zones with oils and lubricants</li> </ul>	YM2D24-050PN1MRJA4	2106184
	<ul style="list-style-type: none"> <li><b>Connection type head A:</b> Male connector, M12, 4-pin, straight, D-coded</li> <li><b>Connection type head B:</b> Male connector, RJ45, 8-pin, straight</li> <li><b>Signal type:</b> Ethernet</li> <li><b>Cable:</b> 5 m, 4-wire, AWG26, PUR, halogen-free</li> <li><b>Description:</b> Ethernet, twisted pair, shielded</li> </ul>	YM2D24-050EA1MRJA4	6034415
	<ul style="list-style-type: none"> <li><b>Connection type head A:</b> Male connector, M12, 4-pin, straight, D-coded</li> <li><b>Connection type head B:</b> Male connector, RJ45, 4-pin, straight</li> <li><b>Signal type:</b> Ethernet, PROFINET</li> <li><b>Cable:</b> 2 m, 4-wire, PUR, halogen-free</li> <li><b>Description:</b> Ethernet, PROFINET, shielded</li> <li><b>Application:</b> Drag chain operation, Zones with oils and lubricants</li> </ul>	YM2D24-020PN1MRJA4	2106182
	<ul style="list-style-type: none"> <li><b>Connection type head A:</b> Male connector, M12, 4-pin, angled, D-coded</li> <li><b>Connection type head B:</b> Male connector, RJ45, 4-pin, straight</li> <li><b>Signal type:</b> Ethernet, PROFINET</li> <li><b>Cable:</b> 10 m, 4-wire, PUR, halogen-free</li> <li><b>Description:</b> Ethernet, PROFINET, shielded</li> <li><b>Application:</b> Drag chain operation, Zones with oils and lubricants</li> </ul>	YN2D24-100PN1MRJA4	2106164
	<ul style="list-style-type: none"> <li><b>Connection type head A:</b> Male connector, M12, 4-pin, angled, D-coded</li> <li><b>Connection type head B:</b> Male connector, RJ45, 4-pin, straight</li> <li><b>Signal type:</b> Ethernet, PROFINET</li> <li><b>Cable:</b> 5 m, 4-wire, PUR, halogen-free</li> <li><b>Description:</b> Ethernet, PROFINET, shielded</li> <li><b>Application:</b> Drag chain operation, Zones with oils and lubricants</li> </ul>	YN2D24-050PN1MRJA4	2106163
	<ul style="list-style-type: none"> <li><b>Connection type head A:</b> Male connector, M12, 4-pin, angled, D-coded</li> <li><b>Connection type head B:</b> Flying leads</li> <li><b>Signal type:</b> Ethernet, PROFINET</li> <li><b>Cable:</b> 5 m, 4-wire, PUR, halogen-free</li> <li><b>Description:</b> Ethernet, PROFINET, shielded</li> <li><b>Application:</b> Drag chain operation, Zones with oils and lubricants</li> </ul>	YN2D24-050PN1XLEAX	2106175
	<ul style="list-style-type: none"> <li><b>Connection type head A:</b> Male connector, M12, 4-pin, angled, D-coded</li> <li><b>Connection type head B:</b> Male connector, RJ45, 4-pin, straight</li> <li><b>Signal type:</b> Ethernet, PROFINET</li> <li><b>Cable:</b> 3 m, 4-wire, PUR, halogen-free</li> <li><b>Description:</b> Ethernet, PROFINET, shielded</li> <li><b>Application:</b> Drag chain operation, Zones with oils and lubricants</li> </ul>	YN2D24-030PN1MRJA4	2144265

## SICK AT A GLANCE

SICK is one of the leading manufacturers of intelligent sensors and sensor solutions for industrial applications. A unique range of products and services creates the perfect basis for controlling processes securely and efficiently, protecting individuals from accidents and preventing damage to the environment.

We have extensive experience in a wide range of industries and understand their processes and requirements. With intelligent sensors, we can deliver exactly what our customers need. In application centers in Europe, Asia and North America, system solutions are tested and optimized in accordance with customer specifications. All this makes us a reliable supplier and development partner.

Comprehensive services complete our offering: SICK LifeTime Services provide support throughout the machine life cycle and ensure safety and productivity.

For us, that is “Sensor Intelligence.”

## WORLDWIDE PRESENCE:

Contacts and other locations –[www.sick.com](http://www.sick.com)