



# NAV245-10100

NAV2xx

2D LIDAR SENSORS

**SICK**  
Sensor Intelligence.



### Ordering information

Type	Part no.
NAV245-10100	1074308

Other models and accessories → [www.sick.com/NAV2xx](http://www.sick.com/NAV2xx)



### Detailed technical data

#### Features

<b>Task</b>	Localizing, navigating and guiding - Localizing Determining position - 2D position determination
<b>Application</b>	Outdoor
<b>Light source</b>	Laser diode (905 nm)
<b>Laser class</b>	1 (IEC 60825-1:2014, EN 60825-1:2014)
<b>Aperture angle</b>	Horizontal 270°
<b>Scanning frequency</b>	≥ 25 Hz
<b>Angular resolution</b>	0.001°, on reflectors 0.25°, on raw / contour data
<b>Working range</b>	0.5 m ... 50 m (30 m on reflectors)
<b>Scanning range</b>	At 10% remission factor 18 m At 90% remission factor 50 m

#### Mechanics/electronics

<b>Connection type</b>	4 x M12 male connector/female connector
<b>Supply voltage</b>	10.8 V DC ... 30 V DC
<b>Power consumption</b>	Typ. 8 W, heating typ. 35 W
<b>Housing material</b>	Aluminum die cast
<b>Housing color</b>	Light blue (RAL 5012)
<b>Enclosure rating</b>	IP67 (EN 60529/A1 (2002-02))
<b>Protection class</b>	III (EN 61140 (2002-03))
<b>Weight</b>	1.1 kg
<b>Dimensions (L x W x H)</b>	124.9 mm x 102 mm x 163 mm
<b>MTBF</b>	> 100 years

Safety-related parameters

<b>MTTF<sub>D</sub></b>	> 100 years
-------------------------	-------------

Performance

<b>Systematic error</b>	Typ. ± 10 mm (RDI) Typ. ± 30 mm (Contour)
<b>Statistical error</b>	Typ. 8 mm (RDI) <sup>1)</sup> Typ. 12 mm (Contour) <sup>1)</sup>
<b>Temperature drift</b>	Typ. 0.1 mm/K

<sup>1)</sup> 1 sigma.

Interfaces

<b>Ethernet</b>	Function	✓, TCP/IP
	Data transmission rate	10/100 MBit/s
<b>Serial</b>	Function	✓, RS-232
	Data transmission rate	9.6 kBaud ... 115.2 kBaud
<b>Optical indicators</b>		4 LED

Ambient data

<b>Electromagnetic compatibility (EMC)</b>	EN 61000-6-2:2005-08 / EN 61000-6-4 (2007-01)
<b>Vibration resistance</b>	EN 60068-2-6 (1995-04)
<b>Ambient operating temperature</b>	-30 °C ... +50 °C
<b>Storage temperature</b>	-30 °C ... +70 °C
<b>Permissible relative humidity</b>	≤ 85 %, Non-condensing

General notes

<b>Note on use</b>	The sensor does not constitute a safety component as defined by relevant legislation on machine safety.
--------------------	---

Classifications

<b>ECLASS 5.0</b>	27270990
<b>ECLASS 5.1.4</b>	27270990
<b>ECLASS 6.0</b>	27270913
<b>ECLASS 6.2</b>	27270913
<b>ECLASS 7.0</b>	27270913
<b>ECLASS 8.0</b>	27270913
<b>ECLASS 8.1</b>	27270913
<b>ECLASS 9.0</b>	27270913
<b>ECLASS 10.0</b>	27270913
<b>ECLASS 11.0</b>	27270913
<b>ECLASS 12.0</b>	27270913
<b>ETIM 5.0</b>	EC002550
<b>ETIM 6.0</b>	EC002550
<b>ETIM 7.0</b>	EC002550

<b>ETIM 8.0</b>	EC002550
<b>UNSPSC 16.0901</b>	41111615

**Dimensional drawing** (Dimensions in mm (inch))

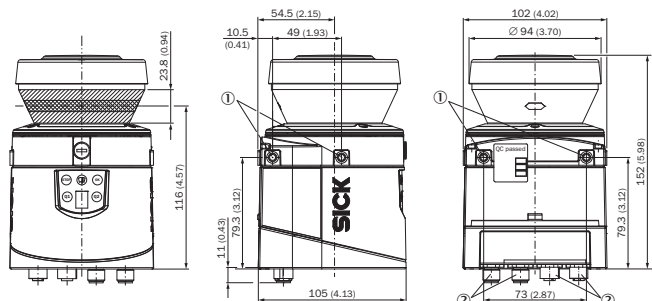

- ① Mounting hole M5 x 7.5
- ② Connector M12



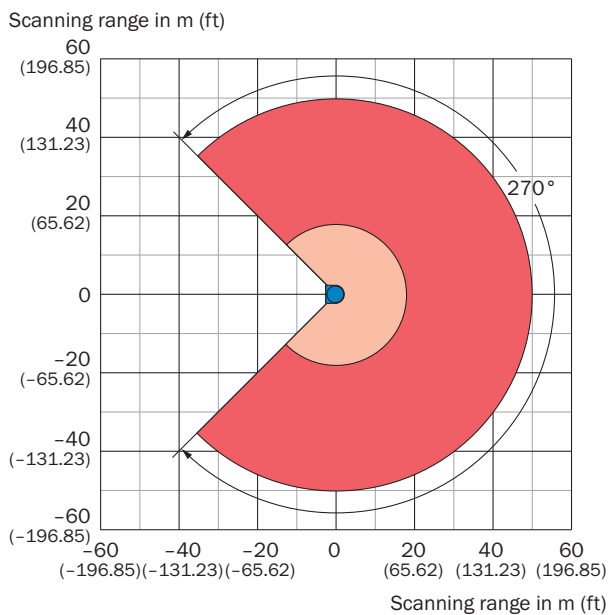



**Working range diagram**



- Scanning range max. 50 m (164.04 ft)
- Scanning range for objects up to 10 % remission 18 m (59.06 ft)

## Recommended accessories

Other models and accessories → [www.sick.com/NAV2xx](http://www.sick.com/NAV2xx)

	Brief description	Type	Part no.
<b>Mounting brackets and plates</b>			
	1 piece, mounting bracket for rear mounting on wall or machine	Mounting kit 1a	2034324
	1 piece, mounting bracket for rear mounting on wall or machine with protection of optics hood	Mounting kit 1b	2034325
	1 piece, mounting bracket, adjustable lateral axis, only in conjunction with mounting kit 1a (2034324) or 1b (2034325)	Mounting kit 2	2039302
	1 piece, mounting plate, adjustable longitudinal axis, only in conjunction with mounting kit 2 (2039302)	Mounting kit 3	2039303
<b>Others</b>			
	<ul style="list-style-type: none"> <li><b>Connection type head A:</b> Female connector, M12, 5-pin, straight, A-coded</li> <li><b>Connection type head B:</b> Flying leads</li> <li><b>Signal type:</b> Power</li> <li><b>Cable:</b> 5 m, 4-wire, PUR, halogen-free</li> <li><b>Description:</b> Power, shielded</li> <li><b>Connection systems:</b> Flying leads</li> </ul>	YF2A64-050XXXLEAX	6036159
	<ul style="list-style-type: none"> <li><b>Connection type head A:</b> Male connector, M12, 8-pin, straight, A-coded</li> <li><b>Connection type head B:</b> Flying leads</li> <li><b>Signal type:</b> Sensor/actuator cable</li> <li><b>Cable:</b> 5 m, 8-wire, PUR, halogen-free</li> <li><b>Description:</b> Sensor/actuator cable, shielded</li> <li><b>Connection systems:</b> Flying leads</li> <li><b>Application:</b> Zones with oils and lubricants, Drag chain operation</li> </ul>	YM2A28-050UA6XLEAX	6036155
	<ul style="list-style-type: none"> <li><b>Connection type head A:</b> Male connector, M12, 4-pin, straight, D-coded</li> <li><b>Connection type head B:</b> Male connector, RJ45, 4-pin, straight</li> <li><b>Signal type:</b> Ethernet, PROFINET</li> <li><b>Cable:</b> 5 m, 4-wire, PUR, halogen-free</li> <li><b>Description:</b> Ethernet, PROFINET, shielded</li> <li><b>Application:</b> Drag chain operation, Zones with oils and lubricants</li> </ul>	YM2D24-050PN1MRJA4	2106184

## Recommended services

Additional services → [www.sick.com/NAV2xx](http://www.sick.com/NAV2xx)

	Type	Part no.
<b>Commissioning</b>		
<ul style="list-style-type: none"> <li><b>Product area:</b> 2D LiDAR sensors, 3D LIDAR sensors</li> <li><b>Range of services:</b> Inspection of connection, fine adjustment, configuration of monitored areas, configuration and optimization of parameters as well as tests, Setup of previously defined functions of basic settings, parameters of field application, filters for raw data output and product-specific configuration</li> <li><b>Duration:</b> Additional work will be invoiced separately</li> </ul>	Commissioning LiDAR sensors	1680672

	Type	Part no.
Maintenance		
<ul style="list-style-type: none"> <li>• <b>Product area:</b> 2D LiDAR sensors, 3D LiDAR sensors</li> <li>• <b>Range of services:</b> Inspection, analysis and restoring of defined functions, Inspection and adaptation of basic settings, parameters of field application, filters for raw data output, and product-specific configuration</li> <li>• <b>Duration:</b> Additional work will be invoiced separately</li> </ul>	Maintenance of LiDAR sensors	1682593
Extended warranty		
<ul style="list-style-type: none"> <li>• <b>Product area:</b> Machine vision, LiDAR sensors, safety camera sensors, Safety laser scanners, Safety radar sensors, Radar sensors, Fixed mount barcode scanners, Image-based code readers, RFID, Mobile handheld scanners</li> <li>• <b>Range of services:</b> The services correspond to the scope of the statutory manufacturer warranty (SICK general terms of delivery).</li> <li>• <b>Duration:</b> Five-year warranty from delivery date.</li> </ul>	Extended warranty for a total of five years from delivery date	1680671

## SICK AT A GLANCE

SICK is one of the leading manufacturers of intelligent sensors and sensor solutions for industrial applications. A unique range of products and services creates the perfect basis for controlling processes securely and efficiently, protecting individuals from accidents and preventing damage to the environment.

We have extensive experience in a wide range of industries and understand their processes and requirements. With intelligent sensors, we can deliver exactly what our customers need. In application centers in Europe, Asia and North America, system solutions are tested and optimized in accordance with customer specifications. All this makes us a reliable supplier and development partner.

Comprehensive services complete our offering: SICK LifeTime Services provide support throughout the machine life cycle and ensure safety and productivity.

For us, that is “Sensor Intelligence.”

## WORLDWIDE PRESENCE:

Contacts and other locations –[www.sick.com](http://www.sick.com)