



MICS3-ABAZ90ZA1P01

Safe EFI-pro System

SAFETY SYSTEMS FOR AGVS AND AMRS

SICK
Sensor Intelligence.



Illustration may differ



Ordering information

| Integration in the control system | Sub product family | Protective field range | Number of fields | Number of monitoring cases | Connection type | Type | Part no. |
|-----------------------------------|---------------------------|------------------------|------------------|----------------------------|-----------------|-------------------|----------|
| EFI-pro | microScan3 Core - EFI-pro | 9 m | 8 | 8 | M12 | MICS3-ABAZ90ZA1P0 | 1094455 |

The system plug is pre-assembled on the underside. It can either be mounted on the rear side or the underside.

Other models and accessories → www.sick.com/Safe_EFI-pro_System

Detailed technical data

Features

| | |
|--|---|
| Sub product family | microScan3 Core - EFI-pro |
| Model | Sensor including system plug (pre-mounted on the underside) |
| Application | Indoor |
| Protective field range | 9 m |
| Warning field range | 64 m |
| Number of simultaneously monitored fields | ≤ 4 ¹⁾ |
| Number of fields | 8 |
| Number of monitoring cases | 8 |
| Scanning angle | 275° |
| Resolution (can be configured) | 30 mm 40 mm 50 mm 60 mm 70 mm 150 mm 200 mm |
| Angular resolution | 0.1° |
| Response time | ≥ 115 ms |
| Protective field supplement | 100 mm |

¹⁾ Protection, warning or contour detection fields.

Safety-related parameters

| | |
|-------------------------------|---------------------------|
| Type | Type 3 (IEC 61496) |
| Safety integrity level | SIL 2 (IEC 61508) |
| Category | Category 3 (EN ISO 13849) |

| | |
|---|---|
| Performance level | PL d (EN ISO 13849) |
| PFH_D (mean probability of a dangerous failure per hour) | 8.0 x 10 ⁻⁸ |
| T_M (mission time) | 20 years (EN ISO 13849) |
| Safe state in the event of a fault | The safety outputs via the network are logic 0. |

Functions

| | |
|---|--------------|
| Restart interlock | ✓ |
| Multiple sampling | ✓ |
| Monitoring case switching | ✓ |
| Simultaneous monitoring | ✓ |
| Static protective field switching | ✓ |
| Safe contour detection | ✓ |
| Contour as a reference | ✓ |
| Integrated configuration memory | ✓ |
| Measured data output | Via Ethernet |
| Safe SICK device communication via EFI-pro | ✓ |

Interfaces

| | | |
|--|---------------------------------|---|
| Connection type | | |
| | Voltage supply | 1 x male connector, M12, 4-pin, A-coded |
| | Fieldbus, industrial network | 2 x M12 female connectors, 4-pin, D-coded |
| Outputs | | |
| | OSSD pairs | 0 |
| | Safety outputs via network | 4 |
| Configuration method | | PC with Safety Designer (Configuration and Diagnostic Software) |
| Configuration and diagnostics interface | | USB 2.0, Mini-USB, Ethernet |
| Data interface | | |
| | Services | EtherNet/IP™ CIP Safety™ CoLa 2 (configuration and diagnostics using Safety Designer) Data output DHCP SNMP SNTP (client and server) |
| Fieldbus, industrial network | | EFI-pro |
| | RPI (requested packet interval) | 5 ms ... 1,000 ms, multiple of 5 ms |
| Display elements | | Graphic color display, LEDs |

Electrical data

| | |
|-------------------------------------|---------------------------------|
| Protection class | III (EN 61140) |
| Supply voltage V_s | 24 V DC (16.8 V DC ... 30 V DC) |
| Power consumption typical | 7.2 W |

Mechanical data

| | |
|-------------------------------|--|
| Dimensions (W x H x D) | 112 mm x 150.7 mm x 111.1 mm (without system plug) |
| Weight | 1.45 kg |

| | |
|------------------------------------|--|
| Housing material | Aluminum |
| Housing color | RAL 1021 (yellow), RAL 9005 (black) |
| Optics cover material | Polycarbonate |
| Optics cover surface finish | Outside with scratch-resistant coating |

Ambient data

| | |
|--------------------------------------|--|
| Enclosure rating | IP65 (IEC 60529) |
| Ambient light immunity | ≤ 3,000 lx (IEC 61496-3) |
| Ambient operating temperature | -10 °C ... +50 °C |
| Storage temperature | -25 °C ... +70 °C |
| Vibration resistance | IEC 60068-2-6, IEC 60068-2-64, IEC 60721-3-5, IEC TR 60721-4-3, IEC 61496-1, IEC 61496-3 |
| | Class 5M1 (IEC 60721-3-5) 3M4 (IEC TR 60721-4-3) |
| Shock resistance | IEC 60068-2-27, IEC 60721-3-5, IEC TR 60721-4-3, IEC 61496-1, IEC 61496-3 |
| | Class 5M1 (IEC 60721-3-5) 3M4 (IEC TR 60721-4-3) |
| | Continuous shock 100 m/s ² , 16 ms 150 m/s ² , 6 ms |
| EMC | IEC 61496-1, IEC 61000-6-2, IEC 61000-6-4 |

Other information

| | |
|------------------------------------|--|
| Type of light | Pulsed laser diode |
| Wave length | 845 nm |
| Detectable remission factor | 1.8% to several 1000% |
| Laser class | 1M (21 CFR 1040.10 and 1040.11, IEC 60825-1) |

Classifications

| | |
|-----------------------|----------|
| ECLASS 5.0 | 27272705 |
| ECLASS 5.1.4 | 27272705 |
| ECLASS 6.0 | 27272705 |
| ECLASS 6.2 | 27272705 |
| ECLASS 7.0 | 27272705 |
| ECLASS 8.0 | 27272705 |
| ECLASS 8.1 | 27272705 |
| ECLASS 9.0 | 27272705 |
| ECLASS 10.0 | 27272705 |
| ECLASS 11.0 | 27272705 |
| ECLASS 12.0 | 27272705 |
| ETIM 5.0 | EC002550 |
| ETIM 6.0 | EC002550 |
| ETIM 7.0 | EC002550 |
| ETIM 8.0 | EC002550 |
| UNSPSC 16.0901 | 39121528 |

Dimensional drawing (Dimensions in mm (inch))

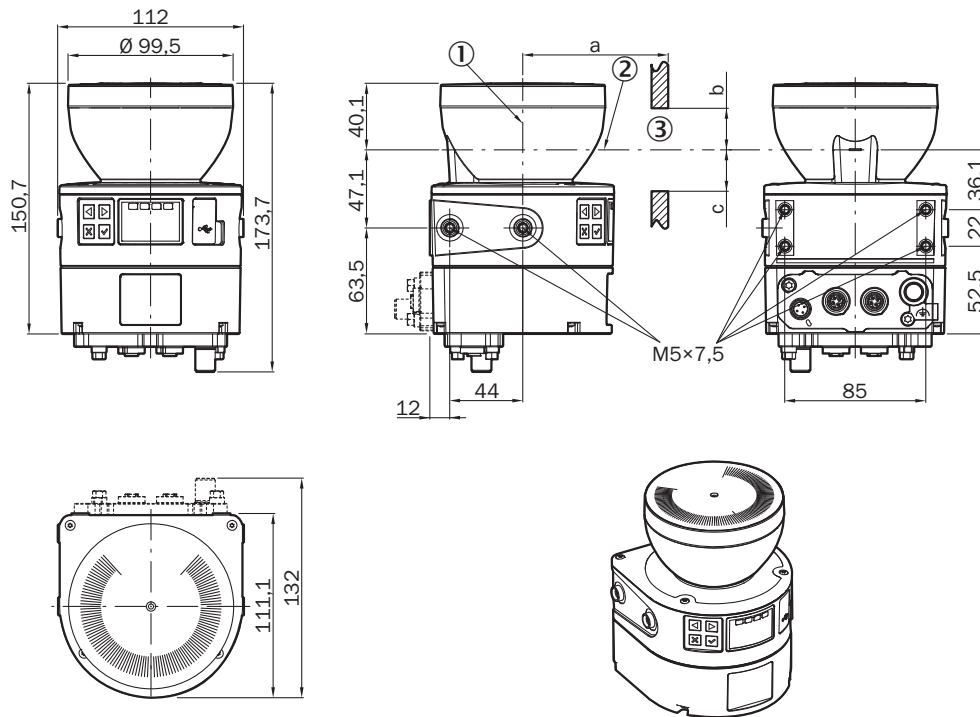

- ① Mirror axis of rotation
- ② Scan plane
- ③ Required viewing slit (a: length of the viewing slit, b: minimum height above the scan plane, c: minimum height below the scan plane. See the operating instructions for details.)

Pinouts

Ethernet (XF1, XF2)

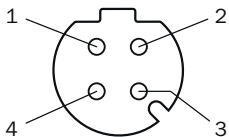

| Pin | Designation | Description |
|--------|-------------|----------------|
| 1 | TX+ | Send data + |
| 2 | RX+ | Receive data + |
| 3 | TX- | Send data - |
| 4 | RX- | Receive data - |
| Thread | SH | Shielding |

For details see operating instructions

Voltage supply (XD1)

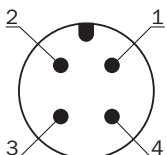

















| Pin | Designation | Description |
|-----|-------------|----------------------------|
| 1 | +24 V DC | Supply voltage +24 V DC |
| 2 | n.c. | Not connected |
| 3 | 0 V DC | Supply voltage 0 V DC |
| 4 | FE | Functional earth/shielding |

For details see operating instructions

Recommended accessories

Other models and accessories → www.sick.com/Safe_EFI-pro_System

| | Brief description | Type | Part no. |
|---|---|--|----------|
| Mounting brackets and plates | | | |
|  | 1 piece, mounting bracket with protection of optics hood, Stainless steel V2A (1.4301), powder-coated IGP-DURA face 5803A | 1b mounting kit | 2074242 |
|  | 1 piece, mounting bracket, heavy-duty version, with protection cover, for floor mounting, height adjustment possible from 90 ... 310 mm, scanner tilt angle: ± 5°. Additional mounting brackets are not required. ⁶ , steel, painted (RAL 1021) | Heavy-duty mounting kit for floor mounting | 2102289 |
|  | 1 piece, mounting bracket 150 mm for floor mounting of microScan3, stainless steel, Bracket and 4 x M5 screws for attaching the microScan3 | Mounting bracket 150 mm for floor mounting of microScan3 | 2112950 |
|  | 1 piece, mounting bracket 300 mm for floor mounting of microScan3, stainless steel, Bracket and 4 x M5 screws for attaching the microScan3 | Mounting bracket 300 mm for floor mounting of microScan3 | 2112951 |
|  | 1 piece, mounting bracket, Stainless steel V2A (1.4301), powder-coated IGP-DURA face 5803A | Mounting kit 1a | 2073851 |
|  | 1 piece, alignment bracket, alignment with cross-wise axis and depth axis possible, distance between mounting surface and device: 22.3 mm, only in conjunction with mounting kit 1a (2073851) or 1b (2074242), Stainless steel V2A (1.4301), powder-coated IGP-DURA face 5803A | Mounting kit 2a | 2073852 |
|  | 1 piece, Alignment bracket, alignment with cross-wise axis and depth axis possible, distance between mounting surface and device: 52.3 mm, only in conjunction with mounting kit 1a (2073851) or 1b (2074242), Stainless steel V2A (1.4301), powder-coated IGP-DURA face 5803A | Mounting kit 2b | 2074184 |
| Plug connectors and cables | | | |
|  | <ul style="list-style-type: none"> Connection type head A: Male connector, M12, 4-pin, straight, D-coded Connection type head B: Male connector, RJ45, 8-pin, straight Signal type: Ethernet Cable: 20 m, 4-wire, CAT5, CAT5e, PUR, halogen-free Description: Ethernet, shielded, Head A: male connector, M12, 4-pin, straight, D coded Head B: male connector, RJ45, 8-pin, straight Cable: PUR, halogen-free, shielded, 2 x 2 x 0.14 mm², Ø 6.4 mm | SSL-2J04-G20ME60 | 6063700 |
|  | <ul style="list-style-type: none"> Connection type head A: Male connector, M12, 4-pin, angled, D-coded Connection type head B: Male connector, RJ45, 8-pin, straight Signal type: Ethernet Cable: 20 m, 4-wire, CAT5, CAT5e, PUR, halogen-free Description: Ethernet, shielded, Head A: male connector, M12, 4-pin, angled, D coded Head B: male connector, RJ45, 8-pin, straight Cable: PUR, halogen-free, shielded, 2 x 2 x 0.14 mm², Ø 6.4 mm | SSL-2J04-H20ME | 6063701 |

| | Brief description | Type | Part no. |
|---|---|--------------------|----------|
| Others | | | |
|  | <ul style="list-style-type: none"> • Connection type head A: Female connector, M12, 4-pin, angled, A-coded • Connection type head B: Flying leads • Signal type: Sensor/actuator cable • Cable: 20 m, 4-wire, PUR, halogen-free • Description: Sensor/actuator cable, unshielded • Application: Zones with oils and lubricants, Drag chain operation, Robot | YG2A14-200UB3XLEAX | 2095770 |
|  | <ul style="list-style-type: none"> • Connection type head A: Female connector, M12, 4-pin, angled, A-coded • Connection type head B: Flying leads • Signal type: Sensor/actuator cable • Cable: 2 m, 4-wire, PUR, halogen-free • Description: Sensor/actuator cable, unshielded • Application: Zones with oils and lubricants, Drag chain operation, Robot | YG2A14-020UB3XLEAX | 2095766 |
|  | <ul style="list-style-type: none"> • Connection type head A: Female connector, M12, 4-pin, angled, A-coded • Connection type head B: Flying leads • Signal type: Sensor/actuator cable • Cable: 5 m, 4-wire, PUR, halogen-free • Description: Sensor/actuator cable, unshielded • Application: Zones with oils and lubricants, Drag chain operation, Robot | YG2A14-050UB3XLEAX | 2095767 |
|  | <ul style="list-style-type: none"> • Connection type head A: Female connector, M12, 4-pin, angled, A-coded • Connection type head B: Flying leads • Signal type: Sensor/actuator cable • Cable: 10 m, 4-wire, PUR, halogen-free • Description: Sensor/actuator cable, unshielded • Application: Zones with oils and lubricants, Drag chain operation, Robot | YG2A14-100UB3XLEAX | 2095768 |
|  | <ul style="list-style-type: none"> • Connection type head A: Female connector, M12, 4-pin, straight, A-coded • Connection type head B: Flying leads • Signal type: Sensor/actuator cable • Cable: 2 m, 4-wire, PUR, halogen-free • Description: Sensor/actuator cable, unshielded • Application: Zones with oils and lubricants, Drag chain operation, Robot | YF2A14-020UB3XLEAX | 2095607 |
|  | <ul style="list-style-type: none"> • Connection type head A: Female connector, M12, 4-pin, straight, A-coded • Connection type head B: Flying leads • Signal type: Sensor/actuator cable • Cable: 5 m, 4-wire, PUR, halogen-free • Description: Sensor/actuator cable, unshielded • Application: Zones with oils and lubricants, Drag chain operation, Robot | YF2A14-050UB3XLEAX | 2095608 |
|  | <ul style="list-style-type: none"> • Connection type head A: Female connector, M12, 4-pin, straight, A-coded • Connection type head B: Flying leads • Signal type: Sensor/actuator cable • Cable: 10 m, 4-wire, PUR, halogen-free • Description: Sensor/actuator cable, unshielded • Application: Zones with oils and lubricants, Drag chain operation, Robot | YF2A14-100UB3XLEAX | 2095609 |
|  | <ul style="list-style-type: none"> • Connection type head A: Female connector, M12, 4-pin, straight, A-coded • Connection type head B: Flying leads • Signal type: Sensor/actuator cable • Cable: 20 m, 4-wire, PUR, halogen-free • Description: Sensor/actuator cable, unshielded • Application: Zones with oils and lubricants, Drag chain operation, Robot | YF2A14-200UB3XLEAX | 2095611 |

| | Brief description | Type | Part no. |
|---|---|--------------------|----------|
|  | <ul style="list-style-type: none"> • Brief description: The software visualizes diagnostic and device information from safety laser scanners in real time, helping to identify error causes faster and reduce maintenance time. • Supported products: All microScan3 variants (except for microScan3 Core I/O variants), outdoorScan3 Pro - EtherNet/IP • Version: 1.0 • Note: With purchase, you accept the product description available under Downloads > Documentation in connection with the General Terms and Conditions for the Supply of Software Products (AVB Software SICK)., With purchase, you accept the product description available under Downloads > Documentation in connection with the General Terms and Conditions for the Supply of Software Products (AVB Software SICK). | SOW/VTL-LI007PCWIO | 1116788 |

SICK AT A GLANCE

SICK is one of the leading manufacturers of intelligent sensors and sensor solutions for industrial applications. A unique range of products and services creates the perfect basis for controlling processes securely and efficiently, protecting individuals from accidents and preventing damage to the environment.

We have extensive experience in a wide range of industries and understand their processes and requirements. With intelligent sensors, we can deliver exactly what our customers need. In application centers in Europe, Asia and North America, system solutions are tested and optimized in accordance with customer specifications. All this makes us a reliable supplier and development partner.

Comprehensive services complete our offering: SICK LifeTime Services provide support throughout the machine life cycle and ensure safety and productivity.

For us, that is “Sensor Intelligence.”

WORLDWIDE PRESENCE:

Contacts and other locations –www.sick.com