



CS81-P1112

CS8

COLOR SENSORS

SICK
Sensor Intelligence.



Ordering information

Type	Part no.
CS81-P1112	1028224

Other models and accessories → www.sick.com/CS8



Detailed technical data

Features

Dimensions (W x H x D)	30.4 mm x 80 mm x 53 mm
Sensing distance	12.5 mm ¹⁾
Sensing distance tolerance	± 3 mm
Housing design (light emission)	Rectangular
Light source	LED, RGB ²⁾
Wave length	640 nm, 525 nm, 470 nm
Light spot size	2 mm x 4 mm
Light spot direction	Vertical
Adjustment	Teach-in button
Teach-in mode	Static 1-point teach-in

¹⁾ From front edge of lens.

²⁾ Average service life: 100,000 h at T_U = +25 °C.

Mechanics/electronics

Supply voltage	10 V DC ... 30 V DC ¹⁾
Ripple	< 5 V _{pp} ²⁾
Current consumption	< 120 mA ³⁾
Switching frequency	1 kHz ⁴⁾ 3 kHz 6 kHz Adjustable

¹⁾ Limit values when operated in short-circuit protected network: max. 8 A.

²⁾ May not exceed or fall below U_v tolerances.

³⁾ Without load.

⁴⁾ With light/dark ratio 1:1.

⁵⁾ Signal transit time with resistive load.

⁶⁾ Consumption count Q1 / Q2.

⁷⁾ AT > 200 µs.

⁸⁾ Reference voltage DC 32 V.

Response time	500 μ s, 160 μ s, 85 μ s ⁵⁾
Switching output	PNP
Switching output (voltage)	PNP: HIGH = $V_S - \leq 2$ V / LOW approx. 0 V
Output (channel)	1 color
Output current I_{max}.	< 100 mA ⁶⁾
Input, teach-in (ET)	PNP Teach: U = 10 V ... < U_V Run: U < 2 V
Input, blanking input (AT)	PNP Blanked: U > 10 V ... < U_V Free-running: U < 2 V ⁷⁾
Retention time (ET)	25 ms, non-volatile memory
Time delay	Deactivation delay 20 ms, shiftable
Connection type	Male connector M12, 5-pin
Protection class	II ⁸⁾
Circuit protection	U_V connections, reverse polarity protected Output Q short-circuit protected Interference pulse suppression
Enclosure rating	IP67
Weight	400 g
Housing material	Metal, zinc diecast

1) Limit values when operated in short-circuit protected network: max. 8 A.

2) May not exceed or fall below U_V tolerances.

3) Without load.

4) With light/dark ratio 1:1.

5) Signal transit time with resistive load.

6) Consumption count Q1 / Q2.

7) AT > 200 μ s.

8) Reference voltage DC 32 V.

Ambient data

Ambient operating temperature	-10 °C ... +55 °C
Ambient storage temperature	-20 °C ... +75 °C
Shock load	According to IEC 60068
UL File No.	NRKH.E181493 & NRKH7.E181493

Classifications

ECl@ss 5.0	27270907
ECl@ss 5.1.4	27270907
ECl@ss 6.0	27270907
ECl@ss 6.2	27270907
ECl@ss 7.0	27270907
ECl@ss 8.0	27270907
ECl@ss 8.1	27270907
ECl@ss 9.0	27270907
ECl@ss 10.0	27270907

ECl@ss 11.0	27270907
ETIM 5.0	EC001817
ETIM 6.0	EC001817
ETIM 7.0	EC001817
UNSPSC 16.0901	39121528

Dimensional drawing (Dimensions in mm (inch))

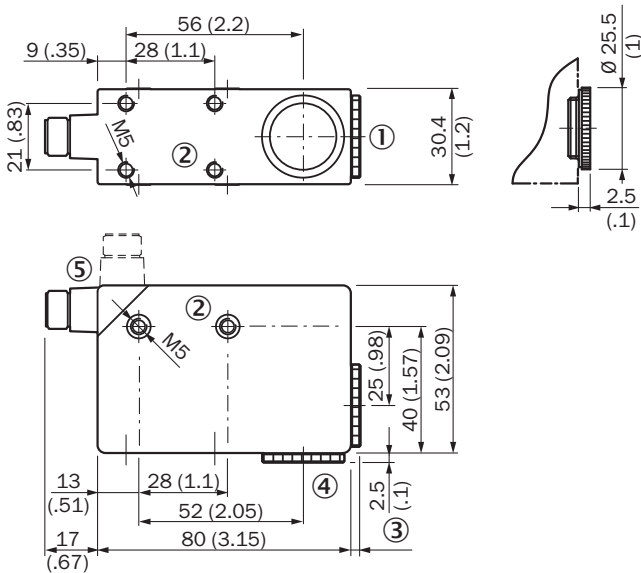

- ① Lens (light emission)
- ② M5 threaded mounting hole, 5.5 mm deep
- ③ See dimensional drawings of lenses
- ④ Blind screw, can be replaced by lens
- ⑤ Connector M12 (rotatable up to 90°)

Adjustments

CS8-1

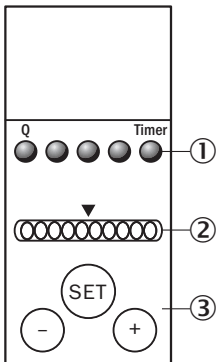

- ① Function signal indicators (yellow)
- ② Bar graph (green), power-on left-hand LED
- ③ Teach-in pushbutton / +/- pushbutton

Connection diagram

Cd-313

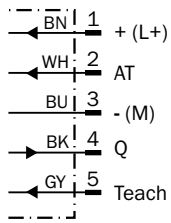

Concept of operation

Setting the switching threshold

1. Trigger teach-in

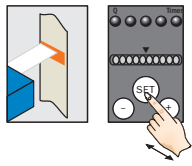

Position object in light field.
Press SET button > 1 s.

2. Select color tolerance

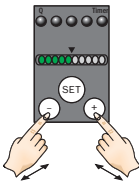

If necessary adapt tolerance with
"+" button (more coarse) or
"-" button (more precise).

3. Confirm teach-in

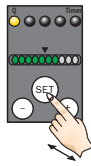

Press SET button > 1 s.
Color correspondence is
visualized via bar graph display.

Display of the color correspondence

1. Full correspondence

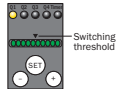

Color detected
= Q active.

2. Correspondence

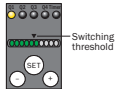

Color just detected
= Q active.

3. No correspondence

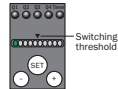

Color not detected
= Q inactive.

Special settings







"Evaluation mode," "Tolerance change during operation," "Show quality," "Time stage," and "Output logic" can be set via a special menu (cf. appropriate operating instructions for the device).

- and ○
- > 1 s = enter/exit
- or ○
- < 1 s = navigate
- SET
- > 1 s = select/confirm

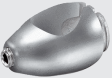
Recommended accessories

Other models and accessories → www.sick.com/CS8

	Brief description	Type	Part no.
Universal bar clamp systems			
	Plate G for universal clamp bracket, steel, zinc coated, Universal clamp (2022726), mounting hardware	BEF-KHS-G01	2022464
	Plate K for universal clamp bracket, steel, zinc coated, Universal clamp (2022726), mounting hardware	BEF-KHS-K01	2022718

	Brief description	Type	Part no.
	Universal clamp bracket for rod mounting, steel, zinc coated, without mounting hardware	BEF-KHS-KH1	2022726
	Mounting bar, straight, 200 mm, steel, steel, zinc coated, without mounting hardware	BEF-MS12G-A	4056054
	Mounting bar, straight, 300 mm, steel, steel, zinc coated, without mounting hardware	BEF-MS12G-B	4056055
	Mounting bar, L-shaped, 150 mm x 150 mm, steel, steel, zinc coated, without mounting hardware	BEF-MS12L-A	4056052
	Mounting bar, L-shaped, 250 x 250 mm, steel, steel, zinc coated, without mounting hardware	BEF-MS12L-B	4056053
Plug connectors and cables			
	Head A: female connector, M12, 5-pin, straight, A-coded Head B: Flying leads Cable: Sensor/actuator cable, PVC, unshielded, 2 m	YF2A15-020VB5XLEAX	2096239
	Head A: female connector, M12, 5-pin, straight, A-coded Head B: Flying leads Cable: Sensor/actuator cable, PVC, unshielded, 5 m	YF2A15-050VB5XLEAX	2096240
	Head A: female connector, M12, 5-pin, straight, A-coded Head B: Flying leads Cable: Sensor/actuator cable, PVC, unshielded, 10 m	YF2A15-100VB5XLEAX	2096241
	Head A: female connector, M12, 5-pin, angled, A-coded Head B: Flying leads Cable: Sensor/actuator cable, PVC, unshielded, 2 m	YG2A15-020VB5XLEAX	2096215
	Head A: female connector, M12, 5-pin, angled, A-coded Head B: Flying leads Cable: Sensor/actuator cable, PVC, unshielded, 5 m	YG2A15-050VB5XLEAX	2096216
	Head A: female connector, M12, 5-pin, angled, A-coded Head B: Flying leads Cable: Sensor/actuator cable, PVC, unshielded, 10 m	YG2A15-100VB5XLEAX	2096217
	Head A: female connector, M12, 5-pin, straight Cable: unshielded	DOS-1205-G	6009719
	Head A: female connector, M12, 5-pin, angled Head B: - Cable: unshielded	DOS-1205-W	6009720

SICK AT A GLANCE

SICK is one of the leading manufacturers of intelligent sensors and sensor solutions for industrial applications. A unique range of products and services creates the perfect basis for controlling processes securely and efficiently, protecting individuals from accidents and preventing damage to the environment.

We have extensive experience in a wide range of industries and understand their processes and requirements. With intelligent sensors, we can deliver exactly what our customers need. In application centers in Europe, Asia and North America, system solutions are tested and optimized in accordance with customer specifications. All this makes us a reliable supplier and development partner.

Comprehensive services complete our offering: SICK LifeTime Services provide support throughout the machine life cycle and ensure safety and productivity.

For us, that is “Sensor Intelligence.”

WORLDWIDE PRESENCE:

Contacts and other locations –www.sick.com