



# DBS60I-BHFM01024

DBS60

INCREMENTAL ENCODERS

**SICK**  
Sensor Intelligence.



Illustration may differ



### Ordering information

Type	Part no.
DBS60I-BHFM01024	1089719

Other models and accessories → [www.sick.com/DBS60](http://www.sick.com/DBS60)

### Detailed technical data

#### Safety-related parameters

<b>MTTF<sub>D</sub> (mean time to dangerous failure)</b>	500 years (EN ISO 13849-1) <sup>1)</sup>
--	--

<sup>1)</sup> This product is a standard product and does not constitute a safety component as defined in the Machinery Directive. Calculation based on nominal load of components, average ambient temperature 40 °C, frequency of use 8760 h/a. All electronic failures are considered hazardous. For more information, see document no. 8015532.

#### Performance

<b>Pulses per revolution</b>	1,024
<b>Measuring step</b>	90°, electric/pulses per revolution
<b>Measuring step deviation</b>	± 18° / pulses per revolution
<b>Error limits</b>	Measuring step deviation x 3
<b>Duty cycle</b>	≤ 0.5 ± 5 %

#### Interfaces

<b>Communication interface</b>	Incremental
<b>Communication Interface detail</b>	TTL / HTL <sup>1)</sup>
<b>Number of signal channels</b>	6-channel
<b>Initialization time</b>	< 5 ms <sup>2)</sup>
<b>Output frequency</b>	≤ 300 kHz <sup>3)</sup>
<b>Load current</b>	≤ 30 mA, per channel
<b>Power consumption</b>	≤ 0.5 W (without load)

<sup>1)</sup> Output level depends on the supply voltage.

<sup>2)</sup> Valid signals can be read once this time has elapsed.

<sup>3)</sup> Up to 450 kHz on request.

#### Electronics

<b>Connection type</b>	Cable, 8-wire, radial, 5 m
<b>Supply voltage</b>	4.5 ... 30 V

<sup>1)</sup> Short-circuit opposite to another channel, US or GND permissible for maximum 30 s.

<b>Reference signal, number</b>	1
<b>Reference signal, position</b>	90°, electric, logically gated with A and B
<b>Reverse polarity protection</b>	✓
<b>Short-circuit protection of the outputs</b>	✓ <sup>1)</sup>

<sup>1)</sup> Short-circuit opposite to another channel, US or GND permissible for maximum 30 s.

## Mechanics

<b>Mechanical design</b>	Blind hollow shaft
<b>Shaft diameter</b>	15 mm
<b>Flange type / stator coupling</b>	2-sided stator coupling, slot, screw hole circle 63–83 mm
<b>Weight</b>	0.44 kg <sup>1)</sup>
<b>Shaft material</b>	Stainless steel V2A
<b>Flange material</b>	Stainless steel V2A
<b>Housing material</b>	Stainless steel V2A
<b>Material, cable</b>	PVC
<b>Shaft sealing ring material</b>	FKM80
<b>Material, cable gland</b>	Stainless steel V2A / Nickel-plated brass
<b>Start up torque</b>	2.1 Ncm (+20 °C)
<b>Operating torque</b>	2 Ncm (+20 °C)
<b>Permissible movement static</b>	± 0.3 mm (radial) ± 0.5 mm (axial)
<b>Permissible movement dynamic</b>	± 0.1 mm ± 0.2 mm
<b>Operating speed</b>	≤ 6,000 min <sup>-1</sup> <sup>2)</sup>
<b>Moment of inertia of the rotor</b>	52 gcm <sup>2</sup>
<b>Bearing lifetime</b>	3.6 x 10 <sup>9</sup> revolutions
<b>Angular acceleration</b>	≤ 500,000 rad/s <sup>2</sup>

<sup>1)</sup> Based on encoder with male connector.

<sup>2)</sup> Maximum speed which does not cause mechanical damage to the encoder. Impact on the service life and signal quality is possible. Please note the maximum output frequency.

## Ambient data

<b>EMC</b>	According to EN 61000-6-2 and EN 61000-6-3
<b>Enclosure rating</b>	IP67, cable connection (IEC 60529)
<b>Permissible relative humidity</b>	90 % (Condensation not permitted)
<b>Operating temperature range</b>	-30 °C ... +100 °C, at maximum 3,000 pulses per revolution
<b>Storage temperature range</b>	-40 °C ... +100 °C, without package
<b>Resistance to shocks</b>	100 g, 6 ms (EN 60068-2-27)
<b>Resistance to vibration</b>	10 g, 10 Hz ... 2,000 Hz (EN 60068-2-6)

## Classifications

<b>ECLASS 5.0</b>	27270501
<b>ECLASS 5.1.4</b>	27270501
<b>ECLASS 6.0</b>	27270590

<b>ECLASS 6.2</b>	27270590
<b>ECLASS 7.0</b>	27270501
<b>ECLASS 8.0</b>	27270501
<b>ECLASS 8.1</b>	27270501
<b>ECLASS 9.0</b>	27270501
<b>ECLASS 10.0</b>	27270501
<b>ECLASS 11.0</b>	27270501
<b>ECLASS 12.0</b>	27270501
<b>ETIM 5.0</b>	EC001486
<b>ETIM 6.0</b>	EC001486
<b>ETIM 7.0</b>	EC001486
<b>ETIM 8.0</b>	EC001486
<b>UNSPSC 16.0901</b>	41112113

### Dimensional drawing (Dimensions in mm (inch))

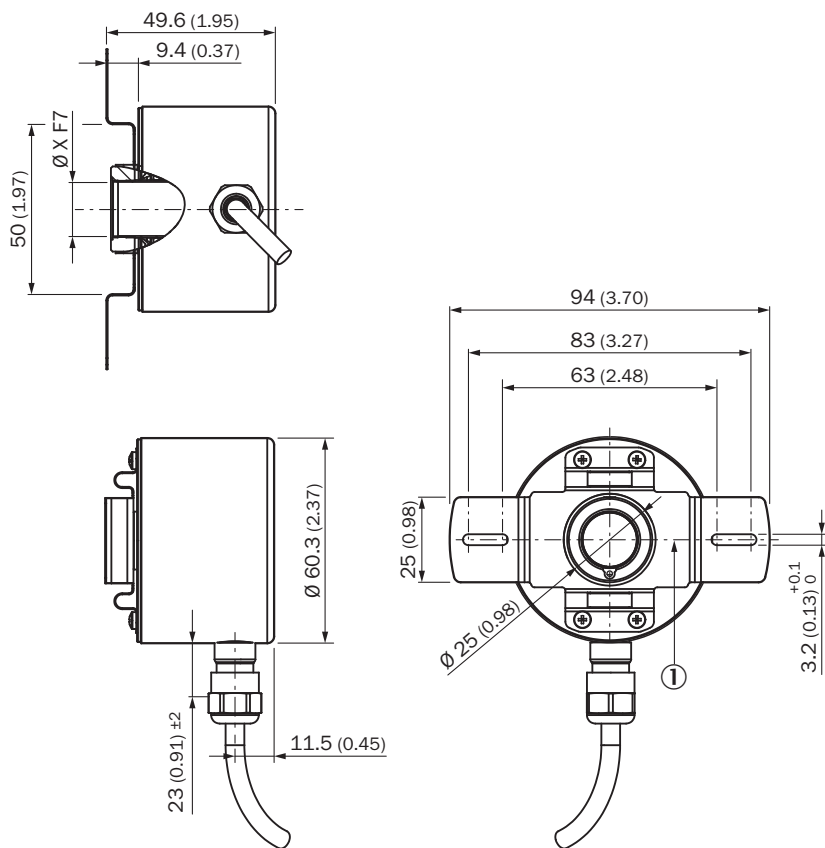

① Zero pulse mark on flange

Type	Shaft diameter XF7	
<b>Blind hollow shaft</b>		
DBS60I-BAxxxxxxx	6 mm	
DBS60I-BBxxxxxxx	8 mm	

Type Blind hollow shaft	Shaft diameter XF7
DBS60I-BDxxxxxxx	10 mm
DBS60I-BExxxxxxx	12 mm
DBS60I-BGxxxxxxx	14 mm
DBS60I-BHxxxxxxx	15 mm

### Attachment specifications

Blind hollow shaft

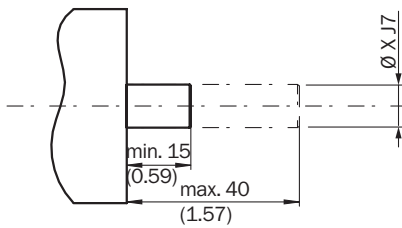

Customer side

Type Blind hollow shaft	Shaft diameter xj7
DBS60I-BAxxxxxxx	6 mm
DBS60I-BBxxxxxxx	8 mm
DBS60I-BDxxxxxxx	10 mm
DBS60I-BExxxxxxx	12 mm
DBS60I-BGxxxxxxx	14 mm
DBS60I-BHxxxxxxx	15 mm

### PIN assignment

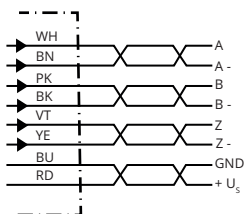

Wire colors (cable connection)	Male connector M12, 8-pin	TTL/HTL signal	Explanation
Brown	1	A-	Signal cable
White	2	A	Signal cable
Black	3	B-	Signal cable
Pink	4	B	Signal cable
Yellow	5	Z-	Signal cable
Purple	6	Z	Signal cable
Blue	7	GND	Ground connection

Wire colors (cable connection)	Male connector M12, 8-pin	TTL/HTL signal	Explanation
Red	8	+U <sub>S</sub>	Supply voltage
Screen	Screen	Screen	Screen connected to housing on encoder side

### Diagrams

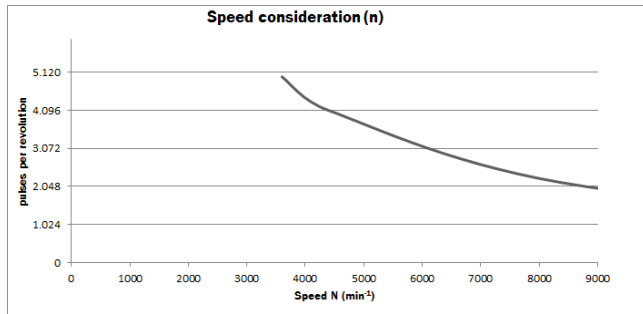

Signal outputs for electrical interfaces TTL and HTL

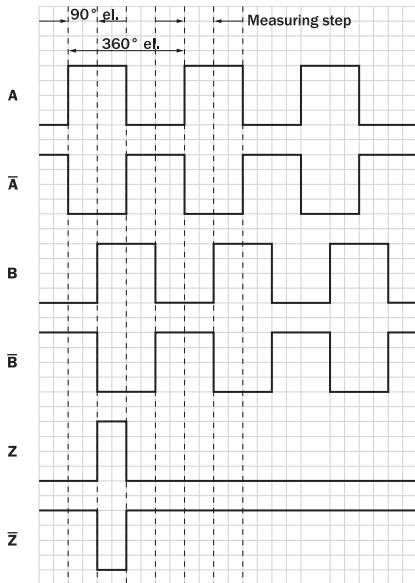

Cw with view on the encoder shaft in direction "A", compare dimensional drawing.

Supply voltage	Output
4,5 V ... 5,5 V	TTL
10 V ... 30 V	TTL
10 V ... 27 V	HTL
4,5 V ... 30 V	TTL/HTL universal
4,5 V ... 30 V	TTL

Operation note

Hollow shaft

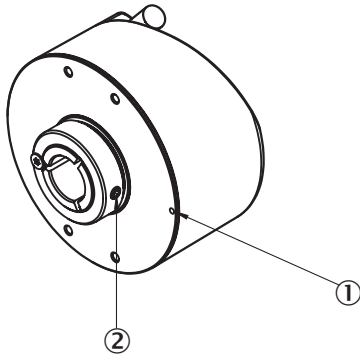













Attention! If stator coupling is mounted, the zero pulse mark can be hidden by the stator coupling

- ① Zero pulse mark on flange
- ② Zero pulse is active when screw of clamping is inline with zero pulse mark on flange or housing mark

Recommended accessories

Other models and accessories → [www.sick.com/DBS60](http://www.sick.com/DBS60)

	Brief description	Type	Part no.
Others			
	<ul style="list-style-type: none"> <li>• <b>Connection type head A:</b> Male connector, M12, 8-pin, straight, A-coded</li> <li>• <b>Description:</b> Shielded</li> <li>• <b>Connection systems:</b> Screw-type terminals</li> <li>• <b>Permitted cross-section:</b> ≤ 0.5 mm<sup>2</sup></li> <li>• <b>Application:</b> Hygienic and washdown zones</li> </ul>	YM12ES8-0050S5586A	2097337
	<ul style="list-style-type: none"> <li>• <b>Connection type head A:</b> Flying leads</li> <li>• <b>Connection type head B:</b> Flying leads</li> <li>• <b>Signal type:</b> SSI, Incremental, HIPERFACE®</li> <li>• <b>Items supplied:</b> By the meter</li> <li>• <b>Cable:</b> 8-wire, PUR, halogen-free</li> <li>• <b>Description:</b> SSI, Incremental, HIPERFACE®, shielded</li> </ul>	LTG-2308-MWENC	6027529
	<ul style="list-style-type: none"> <li>• <b>Connection type head A:</b> Flying leads</li> <li>• <b>Connection type head B:</b> Flying leads</li> <li>• <b>Signal type:</b> SSI, Incremental</li> <li>• <b>Items supplied:</b> By the meter</li> <li>• <b>Cable:</b> 11-wire, PUR</li> <li>• <b>Description:</b> SSI, Incremental, shielded</li> </ul>	LTG-2411-MW	6027530
	<ul style="list-style-type: none"> <li>• <b>Connection type head A:</b> Flying leads</li> <li>• <b>Connection type head B:</b> Flying leads</li> <li>• <b>Signal type:</b> SSI, TTL, HTL, Incremental</li> <li>• <b>Items supplied:</b> By the meter</li> <li>• <b>Cable:</b> 12-wire, UV and saltwater-resistant, PUR, halogen-free</li> <li>• <b>Description:</b> SSI, TTL, HTL, Incremental, shielded, Head A: cable Head B: cable Cable: suitable for drag chain, PUR, halogen-free, shielded, UV and saltwater resistant, 4 x 2 x 0.25 mm<sup>2</sup> + 2 x 0.5 mm<sup>2</sup> + 2 x 0.14 mm<sup>2</sup>, Ø 7.8 mm</li> </ul>	LTG-2612-MW	6028516
	<ul style="list-style-type: none"> <li>• <b>Product family:</b> Stator couplings</li> <li>• <b>Description:</b> Two-sided stator coupling, screw hole circle diameter 63 mm, slot width 3.2 mm</li> </ul>	BEF-DS-09	2076214

	Brief description	Type	Part no.
	<ul style="list-style-type: none"> <li><b>Product family:</b> Stator couplings</li> <li><b>Description:</b> Two-sided stator coupling, slot, slot radius 63 mm – 83 mm, slot width 3.2 mm</li> </ul>	BEF-DS-10	2076215
	<ul style="list-style-type: none"> <li><b>Product family:</b> Stator couplings</li> <li><b>Description:</b> One-sided stator coupling, slots, slot radius 32.75 mm – 142.65 mm, slot width 4.5 mm</li> </ul>	BEF-DS-11	2076216
	<ul style="list-style-type: none"> <li><b>Product family:</b> Stator couplings</li> <li><b>Description:</b> Torque support, 1-sided, slotted hole, screw hole radius 31.5 mm - 48.5 mm, hole width 5.1 mm</li> </ul>	BEF-DS-12	2076217
	<ul style="list-style-type: none"> <li><b>Product family:</b> Stator couplings</li> <li><b>Description:</b> One-sided stator coupling, slot, slot radius 32.1 mm – 37.6 mm, slot width 4.5 mm</li> </ul>	BEF-DS-14	2076678
	<ul style="list-style-type: none"> <li><b>Product family:</b> Flanges and nozzles</li> <li><b>Description:</b> Flange adapter, adaptation of face mount flange with 36 mm centering hub to 50 mm servo flange</li> <li><b>Material:</b> Stainless steel</li> <li><b>Details:</b> Stainless steel</li> <li><b>Items supplied:</b> Including 3 countersunk screws with Precote 85-8 coating; M4*12</li> </ul>	BEF-FA-036-050-I	2094778
	<ul style="list-style-type: none"> <li><b>Product segment:</b> Shaft adaptation</li> <li><b>Product family:</b> Collets</li> <li><b>Description:</b> Collet metal for hollow shaft, shaft diameter 15 mm, outer diameter 5/8" (15.875 mm)</li> </ul>	SPZ-58Z-015-M	2076223
	<ul style="list-style-type: none"> <li><b>Product segment:</b> Shaft adaptation</li> <li><b>Product family:</b> Collets</li> <li><b>Description:</b> Collet plastic (PEEK) insulated for hollow shaft, shaft diameter 15 mm, outer diameter 5/8" (15.875 mm)</li> </ul>	SPZ-58Z-015-P	2076233



## SICK AT A GLANCE

SICK is one of the leading manufacturers of intelligent sensors and sensor solutions for industrial applications. A unique range of products and services creates the perfect basis for controlling processes securely and efficiently, protecting individuals from accidents and preventing damage to the environment.

We have extensive experience in a wide range of industries and understand their processes and requirements. With intelligent sensors, we can deliver exactly what our customers need. In application centers in Europe, Asia and North America, system solutions are tested and optimized in accordance with customer specifications. All this makes us a reliable supplier and development partner.

Comprehensive services complete our offering: SICK LifeTime Services provide support throughout the machine life cycle and ensure safety and productivity.

For us, that is “Sensor Intelligence.”

## WORLDWIDE PRESENCE:

Contacts and other locations –[www.sick.com](http://www.sick.com)