



DBS60E-THFK01000

DBS60

INCREMENTAL ENCODERS

SICK
Sensor Intelligence.



Illustration may differ



Ordering information

Type	Part no.
DBS60E-THFK01000	1080068

Other models and accessories → www.sick.com/DBS60

Detailed technical data

Safety-related parameters

MTTF_D (mean time to dangerous failure)	500 years (EN ISO 13849-1) ¹⁾
--	--

¹⁾ This product is a standard product and does not constitute a safety component as defined in the Machinery Directive. Calculation based on nominal load of components, average ambient temperature 40 °C, frequency of use 8760 h/a. All electronic failures are considered hazardous. For more information, see document no. 8015532.

Performance

Pulses per revolution	1,000
Measuring step	≤ 90°, electric/pulses per revolution
Measuring step deviation	± 18° / pulses per revolution
Error limits	Measuring step deviation x 3
Duty cycle	≤ 0.5 ± 5 %

Interfaces

Communication interface	Incremental
Communication Interface detail	TTL / HTL ¹⁾
Number of signal channels	6-channel
Initialization time	< 5 ms ²⁾
Output frequency	+ 300 kHz ³⁾
Load current	≤ 30 mA, per channel
Power consumption	≤ 0.5 W (without load)

¹⁾ Output level depends on the supply voltage.

²⁾ Valid signals can be read once this time has elapsed.

³⁾ Up to 450 kHz on request.

Electronics

Connection type	Cable, 8-wire, universal, 1.5 m ¹⁾
Supply voltage	4.5 ... 30 V
Reference signal, number	1
Reference signal, position	90°, electric, logically gated with A and B

¹⁾ The universal cable connection is positioned so that it is possible to lay it without bends in a radial or axial direction.

²⁾ Short-circuit opposite to another channel, US or GND permissible for maximum 30 s.

Reverse polarity protection	✓
Short-circuit protection of the outputs	✓ ²⁾

¹⁾ The universal cable connection is positioned so that it is possible to lay it without bends in a radial or axial direction.

²⁾ Short-circuit opposite to another channel, US or GND permissible for maximum 30 s.

Mechanics

Mechanical design	Through hollow shaft
Shaft diameter	15 mm
Flange type / stator coupling	2-sided stator coupling, slot, screw hole circle 63–83 mm
Weight	+ 0.25 kg ¹⁾
Shaft material	Stainless steel
Flange material	Aluminum
Housing material	Aluminum
Material, cable	PVC
Start up torque	+ 0.5 Ncm (+20 °C)
Operating torque	0.4 Ncm (+20 °C)
Permissible movement static	± 0.3 mm (radial) ± 0.5 mm (axial) ²⁾
Permissible movement dynamic	± 0.1 mm (radial) ± 0.2 mm (axial) ²⁾
Operating speed	6,000 min ⁻¹ ³⁾
Maximum operating speed	9,000 min ⁻¹ ⁴⁾
Moment of inertia of the rotor	50 gcm ²
Bearing lifetime	3.6 x 10 ⁹ revolutions
Angular acceleration	≤ 500,000 rad/s ²

¹⁾ Based on encoder with male connector or cable with male connector.

²⁾ Not applicable for stator coupling type C and K.

³⁾ Allow for self-heating of 2.6 K per 1,000 rpm when designing the operating temperature range.

⁴⁾ Maximum speed which does not cause mechanical damage to the encoder. Impact on the service life and signal quality is possible. Please note the maximum output frequency.

Ambient data

EMC	According to EN 61000-6-2 and EN 61000-6-3
Enclosure rating	IP65, housing side (IEC 60529) IP65, shaft side (IEC 60529)
Permissible relative humidity	90 % (Condensation not permitted)
Operating temperature range	-30 °C ... +100 °C, at maximum 3,000 pulses per revolution ¹⁾
Storage temperature range	-40 °C ... +100 °C, without package
Resistance to shocks	250 g, 3 ms (EN 60068-2-27)
Resistance to vibration	30 g, 10 Hz ... 2,000 Hz (EN 60068-2-6)

¹⁾ These values relate to all mechanical versions including recommended accessories unless otherwise noted.

Classifications

ECLASS 5.0	27270501
ECLASS 5.1.4	27270501

ECLASS 6.0	27270590
ECLASS 6.2	27270590
ECLASS 7.0	27270501
ECLASS 8.0	27270501
ECLASS 8.1	27270501
ECLASS 9.0	27270501
ECLASS 10.0	27270501
ECLASS 11.0	27270501
ECLASS 12.0	27270501
ETIM 5.0	EC001486
ETIM 6.0	EC001486
ETIM 7.0	EC001486
ETIM 8.0	EC001486
UNSPSC 16.0901	41112113

Dimensional drawing (Dimensions in mm (inch))

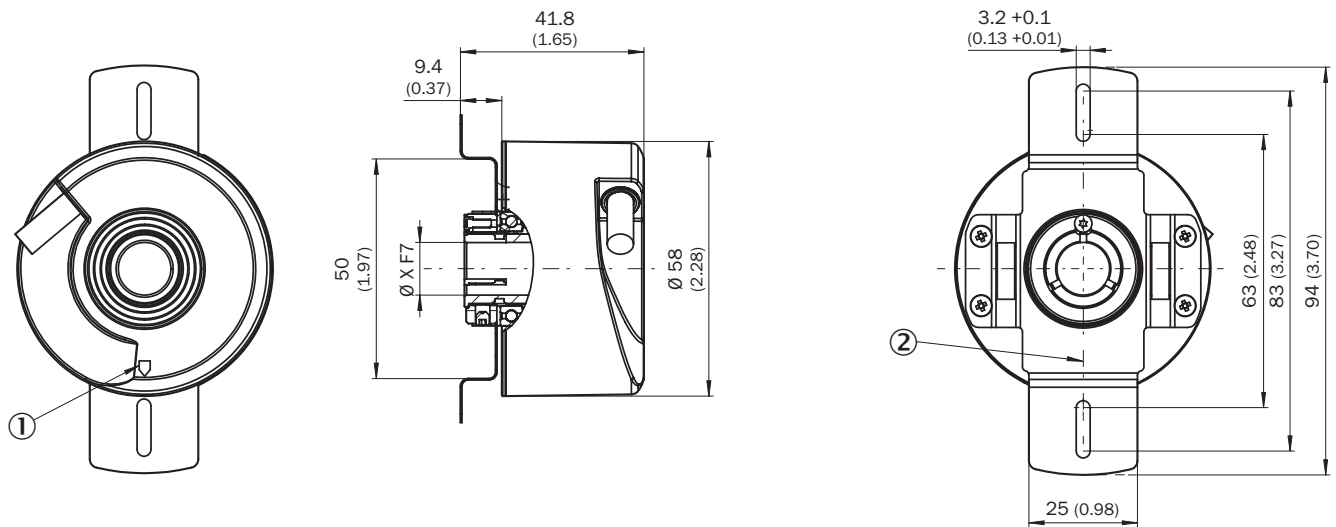

XF7 values see shaft diameter table for through hollow shaft, clamping at the front

- ① Zero pulse mark on housing
- ② Zero pulse mark on flange under stator coupling

Type Through hollow shaft with front clamping	Shaft diameter XF7
DBS60x-TAxxxxxxx DBS60x-T1xxxxxxx	6 mm
DBS60x-TBxxxxxxx DBS60x-T2xxxxxxx	8 mm
DBS60x-TCxxxxxxx DBS60x-T3xxxxxxx	3/8"
DBS60x-TDxxxxxxx DBS60x-T4xxxxxxx	10 mm
DBS60x-TExxxxxxx	12 mm

Type Through hollow shaft with front clamping	Shaft diameter XF7
DBS60x-T5xxxxxxx	
DBS60x-TFxxxxxxx DBS60x-T6xxxxxxx	1/2"
DBS60x-TGxxxxxxx DBS60x-T7xxxxxxx	14 mm
DBS60x-THxxxxxxx DBS60x-T8xxxxxxx	15 mm
DBS60x-TJxxxxxxx	5/8"

Attachment specifications

Through hollow shaft with front clamping

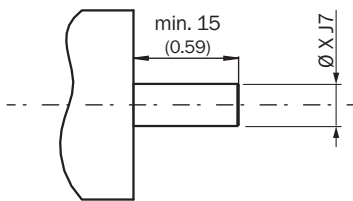

Customer side

Type Through hollow shaft with front clamping	Shaft diameter xj7
DBS60x-TAxxxxxxx DBS60x-T1xxxxxxx	6 mm
DBS60x-TBxxxxxxx DBS60x-T2xxxxxxx	8 mm
DBS60x-TCxxxxxxx DBS60x-T3xxxxxxx	3/8"
DBS60x-TDxxxxxxx DBS60x-T4xxxxxxx	10 mm
DBS60x-TExxxxxxx DBS60x-T5xxxxxxx	12 mm
DBS60x-TFxxxxxxx DBS60x-T6xxxxxxx	1/2"
DBS60x-TGxxxxxxx DBS60x-T7xxxxxxx	14 mm
DBS60x-THxxxxxxx DBS60x-T8xxxxxxx	15 mm
DBS60x-TJxxxxxxx	5/8"

PIN assignment



Wire colors (cable connection)	Male connector M12, 8-pin	Male connector M23, 12-pin	TTL/HTL 6-channel signal	Explanation
Brown	1	6	A-	Signal wire
White	2	5	A	Signal wire
Black	3	1	B-	Signal wire
Pink	4	8	B	Signal wire
Yellow	5	4	Z-	Signal wire
Purple	6	3	Z	Signal wire
Blue	7	10	GND	Ground connection
Red	8	12	+U _s	Supply voltage
-	-	9	Not assigned	Not assigned
-	-	2	Not assigned	Not assigned
-	-	11	Not assigned	Not assigned
-	-	7	Not assigned	Not assigned
Screen	Screen	Screen	Screen	Screen connected to encoder housing

Diagrams

Pulses per revolution



Signal outputs for electrical interfaces TTL and HTL



Cw with view on the encoder shaft in direction "A", compare dimensional drawing.

Supply voltage	Output
4,5 V ... 5,5 V	TTL
10 V ... 30 V	TTL
10 V ... 27 V	HTL
4,5 V ... 30 V	TTL/HTL universal
4,5 V ... 30 V	TTL

Operation note

Hollow shaft



Attention! If stator coupling is mounted, the zero pulse mark can be hidden by the stator coupling

- ① Zero pulse mark on flange
- ② Zero pulse is active when screw of clamping is inline with zero pulse mark on flange or housing mark

Recommended accessories

Other models and accessories → www.sick.com/DBS60

	Brief description	Type	Part no.
Others			
	<ul style="list-style-type: none"> • Connection type head A: Flying leads • Connection type head B: Flying leads • Signal type: SSI, Incremental, HIPERFACE® • Items supplied: By the meter • Cable: 8-wire, PUR, halogen-free • Description: SSI, Incremental, HIPERFACE®, shielded 	LTG-2308-MWENC	6027529
	<ul style="list-style-type: none"> • Connection type head A: Flying leads • Connection type head B: Flying leads • Signal type: SSI, Incremental • Items supplied: By the meter • Cable: 11-wire, PUR • Description: SSI, Incremental, shielded 	LTG-2411-MW	6027530
	<ul style="list-style-type: none"> • Connection type head A: Flying leads • Connection type head B: Flying leads • Signal type: SSI, Incremental • Items supplied: By the meter • Cable: 12-wire, PUR, halogen-free • Description: SSI, Incremental, shielded 	LTG-2512-MW	6027531
	<ul style="list-style-type: none"> • Connection type head A: Flying leads • Connection type head B: Flying leads • Signal type: SSI, TTL, HTL, Incremental • Items supplied: By the meter • Cable: 12-wire, UV and saltwater-resistant, PUR, halogen-free • Description: SSI, TTL, HTL, Incremental, shielded, Head A: cable Head B: cable Cable: suitable for drag chain, PUR, halogen-free, shielded, UV and saltwater resistant, 4 x 2 x 0.25 mm² + 2 x 0.5 mm² + 2 x 0.14 mm², Ø 7.8 mm 	LTG-2612-MW	6028516
	<ul style="list-style-type: none"> • Connection type head A: Male connector, M23, 12-pin, straight, A-coded • Signal type: HIPERFACE®, SSI, Incremental • Description: HIPERFACE®, SSI, Incremental, shielded, Head A: male connector, M23, 12-pin, straight, for cable diameter 5.5 mm ... 10.5 mm Head B: - Operating temperature: -40 °C ... +125 °C • Connection systems: Solder connection 	STE-2312-G01	2077273
	<ul style="list-style-type: none"> • Connection type head A: Male connector, M23, 12-pin, straight, A-coded • Signal type: HIPERFACE®, SSI, Incremental • Description: HIPERFACE®, SSI, Incremental, shielded, M23 female connector with central fixing (for cabinet bushing) • Connection systems: Solder connection 	STE-2312-GX	6028548
	<ul style="list-style-type: none"> • Connection type head A: Male connector, M12, 8-pin, straight, A-coded • Signal type: Incremental • Cable: CAT5, CAT5e • Description: Incremental, shielded, Head A: male connector, M12, 8-pin, straight, A coded, shielded, for cable diameter 4 mm ... 8 mm Head B: - Operating temperature: -40 °C ... +85 °C • Connection systems: IDC quick connection • Permitted cross-section: 0.14 mm² ... 0.34 mm² 	STE-1208-GA01	6044892

SICK AT A GLANCE

SICK is one of the leading manufacturers of intelligent sensors and sensor solutions for industrial applications. A unique range of products and services creates the perfect basis for controlling processes securely and efficiently, protecting individuals from accidents and preventing damage to the environment.

We have extensive experience in a wide range of industries and understand their processes and requirements. With intelligent sensors, we can deliver exactly what our customers need. In application centers in Europe, Asia and North America, system solutions are tested and optimized in accordance with customer specifications. All this makes us a reliable supplier and development partner.

Comprehensive services complete our offering: SICK LifeTime Services provide support throughout the machine life cycle and ensure safety and productivity.

For us, that is “Sensor Intelligence.”

WORLDWIDE PRESENCE:

Contacts and other locations –www.sick.com