



# WL45-R660

W45

COMPACT PHOTOELECTRIC SENSORS

**SICK**  
Sensor Intelligence.



### Ordering information

Type	Part no.
WL45-R660	1008832

Other models and accessories → [www.sick.com/W45](http://www.sick.com/W45)

Illustration may differ



### Detailed technical data

#### Features

<b>Functional principle</b>	Photoelectric retro-reflective sensor
<b>Functional principle detail</b>	Dual lens
<b>Dimensions (W x H x D)</b>	60 mm x 105 mm x 105 mm
<b>Housing design (light emission)</b>	Rectangular
<b>Sensing range max.</b>	1 m ... 55 m <sup>1)</sup>
<b>Sensing range</b>	1 m ... 45 m <sup>1)</sup>
<b>Type of light</b>	Visible red light
<b>Light source</b>	LED <sup>2)</sup>
<b>Light spot size (distance)</b>	Ø 230 mm (16 m)
<b>Adjustment</b>	Potentiometer
<b>Special features</b>	Light switching (pre-setting) Very small light spot and very long sensing range

<sup>1)</sup> OP60-00.

<sup>2)</sup> Average service life: 100,000 h at T<sub>U</sub> = +25 °C.

#### Mechanics/electronics

<b>Supply voltage</b>	20 V AC/DC ... 250 V AC/DC <sup>1)</sup>
<b>Power consumption</b>	≤ 6 VA
<b>Switching output</b>	Relay, electrically isolated <sup>2)</sup>
<b>Output function</b>	Change-over contacts
<b>Switching mode</b>	Light/dark switching <sup>2)</sup>

<sup>1)</sup> Limit values.

<sup>2)</sup> Provide suitable spark suppression for inductive or capacitive loads.

<sup>3)</sup> With light/dark ratio 1:1.

<sup>4)</sup> A = V<sub>S</sub> connections reverse-polarity protected.

<sup>5)</sup> C = interference suppression.

<sup>6)</sup> Up to 140 °C with cooling plates (see accessories).

<b>Switching mode selector</b>	Selectable via time delay selector switch
<b>Switching current (switching voltage)</b>	4 A @ 250 V AC, 4 A @ 24 V DC, 0.125 A @ 120 V DC UL: 4 A @ 250 V AC, general purpose / 2 A @ 250 V AC, pilot duty
<b>Response time</b>	≤ 20 ms
<b>Switching frequency</b>	10 Hz <sup>3)</sup>
<b>Time functions</b>	On delay Off delay ON and OFF delay
<b>Delay time</b>	Adjustable via time delay selector switch, 0.5 s ... 12 s
<b>Connection type</b>	Connector Hirschmann, 6-pin
<b>Circuit protection</b>	A <sup>4)</sup> C <sup>5)</sup>
<b>Protection class</b>	I
<b>Weight</b>	800 g
<b>Polarisation filter</b>	✓
<b>Housing material</b>	Metal
<b>Enclosure rating</b>	IP65
<b>Ambient operating temperature</b>	-25 °C ... +55 °C <sup>6)</sup>
<b>Ambient temperature, storage</b>	-40 °C ... +70 °C
<b>UL File No.</b>	NRKH.E181493 & NRKH7.E181493

<sup>1)</sup> Limit values.

<sup>2)</sup> Provide suitable spark suppression for inductive or capacitive loads.

<sup>3)</sup> With light/dark ratio 1:1.

<sup>4)</sup> A = V<sub>S</sub> connections reverse-polarity protected.

<sup>5)</sup> C = interference suppression.

<sup>6)</sup> Up to 140 °C with cooling plates (see accessories).

## Classifications

<b>eCl@ss 5.0</b>	27270902
<b>eCl@ss 5.1.4</b>	27270902
<b>eCl@ss 6.0</b>	27270902
<b>eCl@ss 6.2</b>	27270902
<b>eCl@ss 7.0</b>	27270902
<b>eCl@ss 8.0</b>	27270902
<b>eCl@ss 8.1</b>	27270902
<b>eCl@ss 9.0</b>	27270902
<b>eCl@ss 10.0</b>	27270902
<b>eCl@ss 11.0</b>	27270902
<b>eCl@ss 12.0</b>	27270902
<b>ETIM 5.0</b>	EC002717
<b>ETIM 6.0</b>	EC002717
<b>ETIM 7.0</b>	EC002717
<b>ETIM 8.0</b>	EC002717
<b>UNSPSC 16.0901</b>	39121528

### Connection diagram

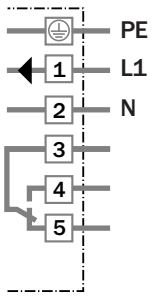

### Characteristic curve

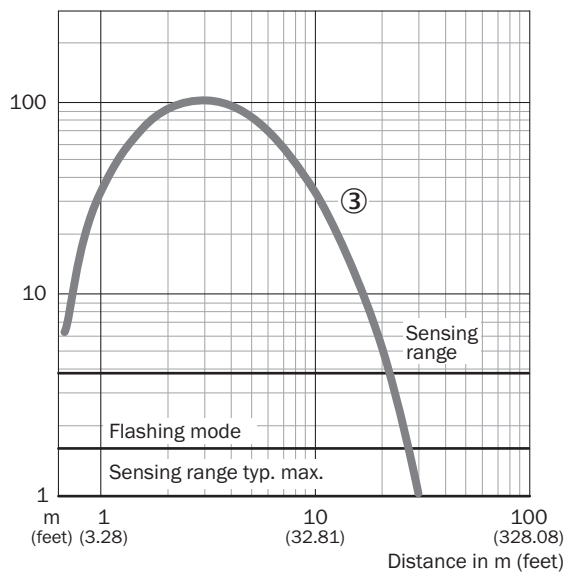

### Sensing range diagram

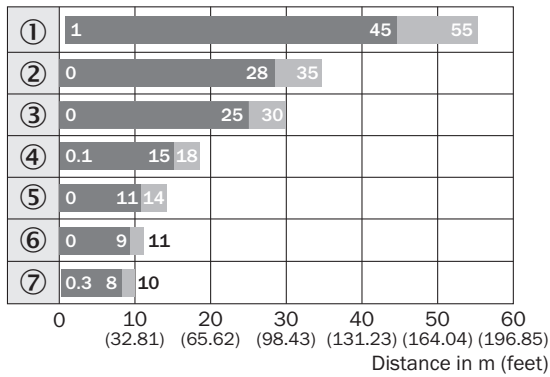

■ Sensing range      ■ Sensing range typ. max.

### Reflector type

- ① OP60 ... ∞
- ② 4 x PL80
- ③ PL80A
- ④ C110
- ⑤ PL50
- ⑥ PL30
- ⑦ Reflective tape  
Diamond Grade

### Adjustments

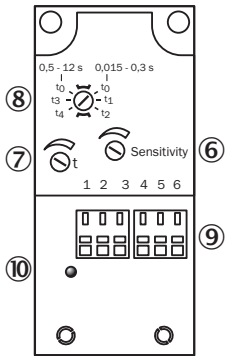

- ⑥ Sensitivity control
- ⑦ Time control
- ⑧ Time delay selector switch
- ⑨ Terminal strip
- ⑩ Status indicator

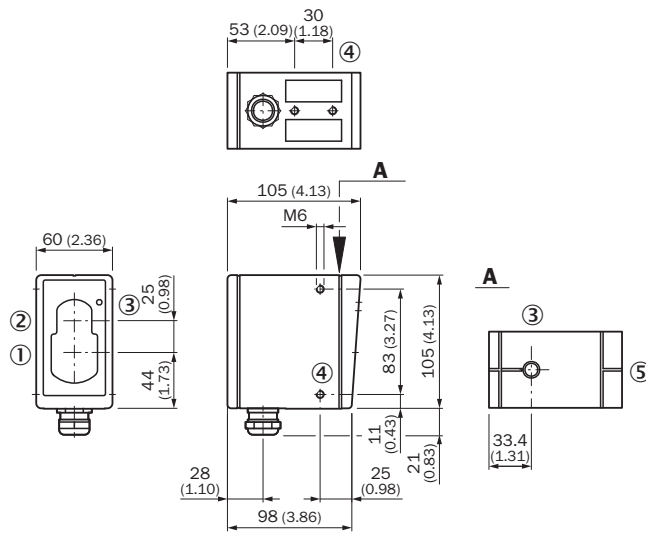

### Dimensional drawing (Dimensions in mm (inch))



- ① Center of optical axis, sender
- ② Center of optical axis, receiver
- ③ LED signal strength indicator
- ④ M6 threaded mounting hole, 8 mm deep
- ⑤ Alignment sight

### Recommended accessories

Other models and accessories → [www.sick.com/W45](http://www.sick.com/W45)

	Brief description	Type	Part no.
<b>Plug connectors and cables</b>			
	Head A: female connector, M26, 7-pin, straight Cable: unshielded 7 crimping contacts enclosed	DOS-0607G000GA3KM0	6006612
<b>Reflectors</b>			
	Rectangular, screw connection, 84 mm x 84 mm, PMMA/ABS, Screw-on, 2 hole mounting	PL80A	1003865

## SICK AT A GLANCE

SICK is one of the leading manufacturers of intelligent sensors and sensor solutions for industrial applications. A unique range of products and services creates the perfect basis for controlling processes securely and efficiently, protecting individuals from accidents and preventing damage to the environment.

We have extensive experience in a wide range of industries and understand their processes and requirements. With intelligent sensors, we can deliver exactly what our customers need. In application centers in Europe, Asia and North America, system solutions are tested and optimized in accordance with customer specifications. All this makes us a reliable supplier and development partner.

Comprehensive services complete our offering: SICK LifeTime Services provide support throughout the machine life cycle and ensure safety and productivity.

For us, that is “Sensor Intelligence.”

## WORLDWIDE PRESENCE:

Contacts and other locations –[www.sick.com](http://www.sick.com)