



TiM881P-2100101

TiM-P

2D LIDAR SENSORS

SICK
Sensor Intelligence.



Ordering information

Type	Part no.
TiM881P-2100101	1090292

Other models and accessories → www.sick.com/TiM-P



Detailed technical data

Features

Application	Outdoor, Indoor
Measurement principle	HDDM ⁺
Light source	Infrared (850 nm)
Laser class	1 (IEC 60825-1:2014, EN 60825-1:2014)
Aperture angle	Horizontal 270°
Scanning frequency	15 Hz
Angular resolution	Horizontal 0.33°
Working range	0.05 m ... 25 m
Scanning range	At 10% remission factor 8 m

Mechanics/electronics

Connection type	1 x "Ethernet" connection, 4-pin M12 female connector 1 x connection "Power", 12-pin, M12 male connector 1 x Micro USB female connector, type B
Supply voltage	9 V DC ... 28 V DC
Power consumption	Typ. 4 W, 16 W with 4 max. loaded digital outputs
Housing color	Gray (RAL 7032)
Enclosure rating	IP67, applies only when the plastic cover of the "Aux interface" is closed (IEC 60529:1989+AMD1:1999+AMD2:2013)
Protection class	III (IEC 61140:2016-1)
Weight	250 g, without connecting cables
Dimensions (L x W x H)	60 mm x 60 mm x 86 mm

Performance

Response time	1 scan, typ. 67 ms 2 scans, ≤ 134 ms
Detectable object shape	Almost any
Systematic error	± 60 mm ¹⁾
Statistical error	< 20 mm ¹⁾
Integrated application	Programmable

¹⁾ Typical value at 90% remission up to maximum scanning range; real value depends on ambient conditions.

Interfaces

Ethernet	✓, TCP/IP
USB	✓
Remark	Micro USB
Digital inputs	4 (PNP)
Digital outputs	4 (PNP)
Delay time	67 ms ... 30,000 ms
Dwell time	67 ms ... 10,000 ms
Optical indicators	2 LEDs
Operator interfaces	Web server, SOPAS ET (diagnostics)
Configuration software	SICK AppStudio

Ambient data

Object remission	4 % ... > 1,000 % (reflectors)
Electromagnetic compatibility (EMC)	
Emitted radiation	Residential area (IEC 61000-6-3:2006+AMD1:2010)
Electromagnetic immunity	Industrial environment (IEC 61000-6-2:2005)
Vibration resistance	
Sine resonance scan	10 Hz ... 1,000 Hz ¹⁾
Sine test	10 Hz ... 500 Hz, 5 g, 10 frequency cycles ¹⁾
Noise test	10 Hz ... 250 Hz, 4.24 g RMS, 5 h ²⁾
Shock resistance	50 g, 11 ms, ± 3 single shocks/axis ³⁾ 25 g, 6 ms, ± 1,000 continuous shocks/axis ³⁾ 50 g, 6 ms, ± 5,000 continuous shocks/axis ³⁾
Ambient operating temperature	-25 °C ... +50 °C
Storage temperature	-40 °C ... +75 °C
Temperature change	-25 °C ... +50 °C, 10 cycles ⁴⁾
Damp heat	+25 °C ... +55 °C, 95 % RH, 6 cycles ⁵⁾
Permissible relative humidity	
Operation	< 80 %, Non-condensing (EN 60068-2-30:2005)

¹⁾ IEC 60068-2-6:2007.

²⁾ IEC 60068-2-64:2008.

³⁾ IEC 60068-2-27:2008.

⁴⁾ EN 60068-2-14:2009.

⁵⁾ EN 60068-2-30:2005.

	Storage	≤ 90 %, Non-condensing (EN 60068-2-30:2005)
Ambient light immunity		80,000 lx

- ¹⁾ IEC 60068-2-6:2007.
- ²⁾ IEC 60068-2-64:2008.
- ³⁾ IEC 60068-2-27:2008.
- ⁴⁾ EN 60068-2-14:2009.
- ⁵⁾ EN 60068-2-30:2005.

General notes

Note on use	The sensor does not constitute a safety component as defined by relevant legislation on machine safety.
--------------------	---

Classifications

ECLASS 5.0	27270990
ECLASS 5.1.4	27270990
ECLASS 6.0	27270913
ECLASS 6.2	27270913
ECLASS 7.0	27270913
ECLASS 8.0	27270913
ECLASS 8.1	27270913
ECLASS 9.0	27270913
ECLASS 10.0	27270913
ECLASS 11.0	27270913
ECLASS 12.0	27270913
ETIM 5.0	EC002550
ETIM 6.0	EC002550
ETIM 7.0	EC002550
ETIM 8.0	EC002550
UNSPSC 16.0901	41111615

Dimensional drawing (Dimensions in mm (inch))

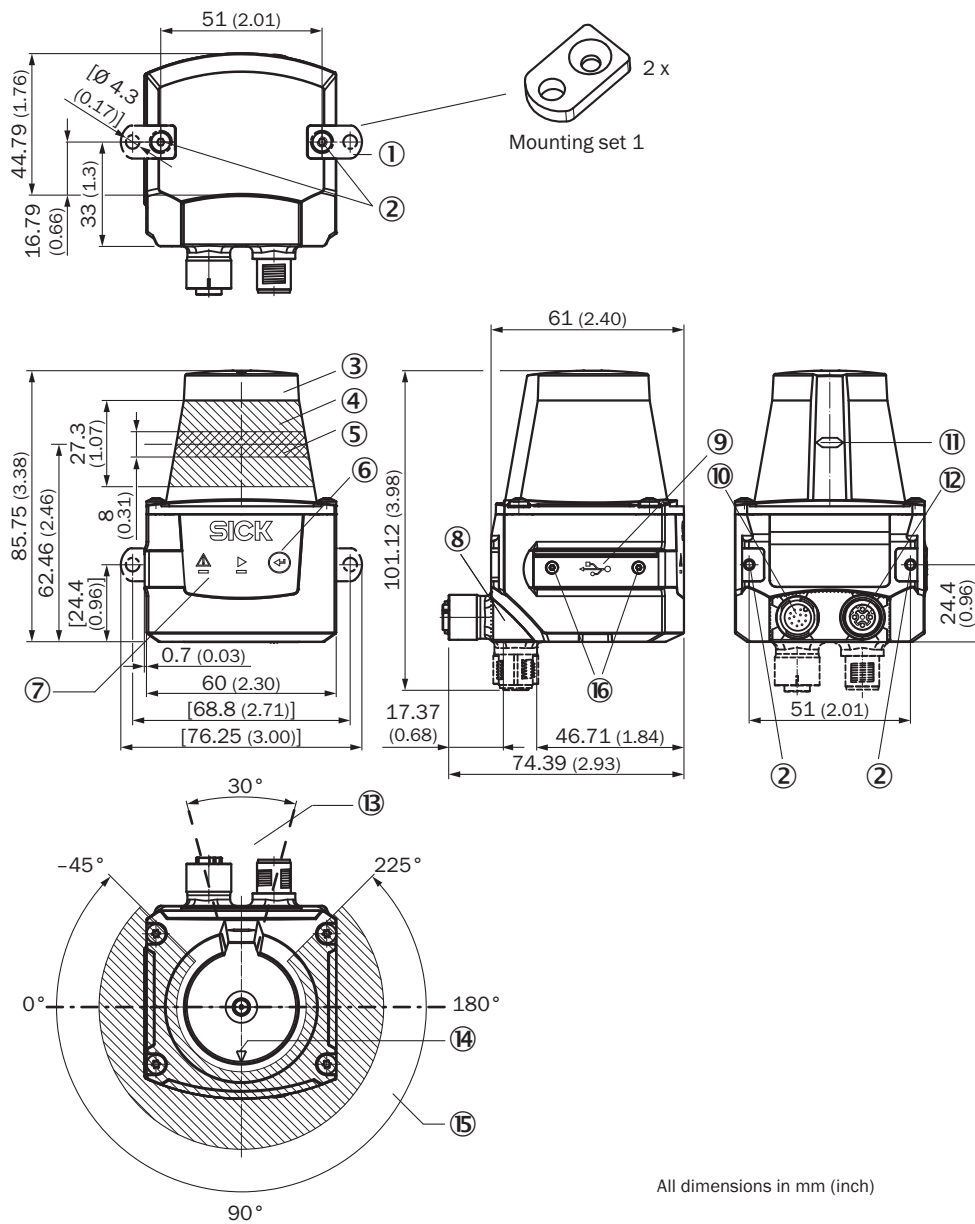

All dimensions in mm (inch)

- ① 2 x straight plates with M3 x 4 mm screw (included in delivery)
- ② M3 threaded mounting hole, 2.8 mm deep (blind hole thread), max. tightening torque 0.8 Nm
- ③ Optical hood
- ④ Receiving range (light inlet)
- ⑤ Transmission range (light emission)
- ⑥ Function button for teach-in
- ⑦ Red and green LED (status displays)
- ⑧ Swivel connector unit
- ⑨ Micro USB female connector, type B
- ⑩ Connection "Power", 12-pin, M12 male connector
- ⑪ Marking for the position of the light emission level
- ⑫ "Ethernet" connection, 4-pin M12 female connector
- ⑬ Area in which no reflective surfaces are allowed for mounted devices
- ⑭ Bearing marking to support alignment (90° axis)
- ⑮ Aperture angle 270° (scanning angle)
- ⑯ 2 x countersunk screw (Torx TX 6) M2 x 4 mm

Working range diagram

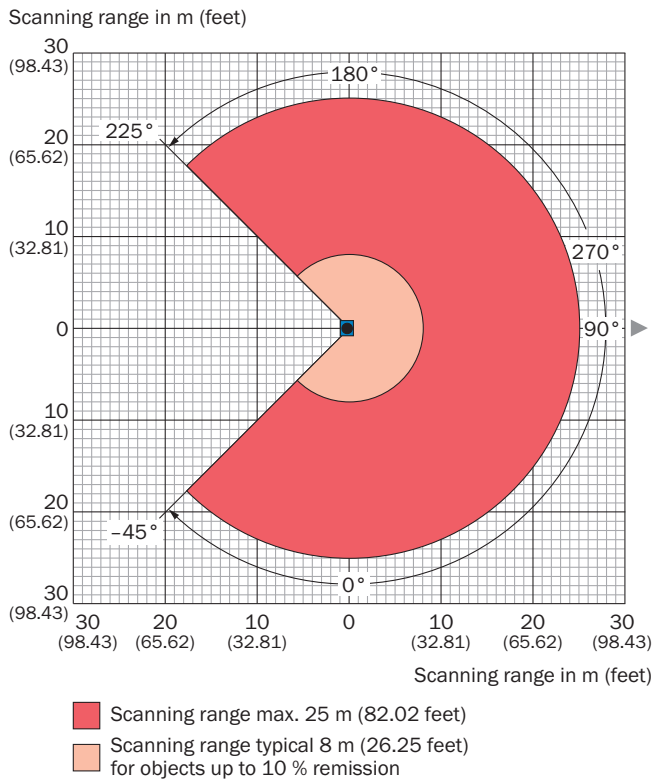

Connection type

Ethernet

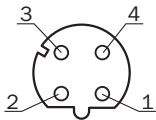

M12 female connector, 4-pin, D-coded

- ① TX+
- ② RX+
- ③ TX-
- ④ RX-

PIN assignment

Power I/O connection

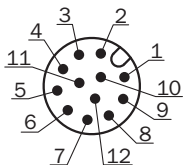

Connecting cable with male connector or M12 male connector, 12-pin, A-coded

- ① GND
- ② DC 9 V ... 28 V
- ③ In₁
- ④ In₂
- ⑤ OUT1
- ⑥ OUT2
- ⑦ OUT3
- ⑧ OUT4
- ⑨ PNP: INGND, NPN: IN 9 V ... 28 V
- ⑩ In₃
- ⑪ In₄
- ⑫ nc



Overview

SICK AppSpace



Recommended accessories

Other models and accessories → www.sick.com/TiM-P

	Brief description	Type	Part no.
Mounting brackets and plates			
	Mounting kit with shock absorber, Anodized aluminum, mounting hardware included	Mounting kit	2086074
Others			
	<ul style="list-style-type: none"> • Connection type head A: Female connector, M12, 12-pin, straight, A-coded • Connection type head B: Flying leads • Signal type: Sensor/actuator cable • Cable: 5 m, 12-wire, PUR • Description: Sensor/actuator cable, shielded • Connection systems: Flying leads 	YF2A6B-050UD3XLEAX	6054974
	<ul style="list-style-type: none"> • Connection type head A: Male connector, M12, 4-pin, straight, D-coded • Connection type head B: Male connector, RJ45, 8-pin, straight • Signal type: PROFINET • Cable: 5 m, 4-wire, AWG26, PVC • Description: PROFINET, shielded 	YM2D24-050EB2MRJA4	6050200

Recommended services

Additional services → www.sick.com/TiM-P

	Type	Part no.
Maintenance		
<ul style="list-style-type: none"> • Product area: 2D LiDAR sensors, 3D LiDAR sensors • Range of services: Inspection, analysis and restoring of defined functions, Inspection and adaptation of basic settings, parameters of field application, filters for raw data output, and product-specific configuration • Duration: Additional work will be invoiced separately 	Maintenance of LiDAR sensors	1682593
Commissioning		
<ul style="list-style-type: none"> • Product area: 2D LiDAR sensors, 3D LiDAR sensors • Range of services: Inspection of connection, fine adjustment, configuration of monitored areas, configuration and optimization of parameters as well as tests, Setup of previously defined functions of basic settings, parameters of field application, filters for raw data output and product-specific configuration • Duration: Additional work will be invoiced separately 	Commissioning LiDAR sensors	1680672
Extended warranty		
<ul style="list-style-type: none"> • Product area: Machine vision, LiDAR sensors, safety camera sensors, Safety laser scanners, Safety radar sensors, Radar sensors, Fixed mount barcode scanners, Image-based code readers, RFID, Mobile handheld scanners • Range of services: The services correspond to the scope of the statutory manufacturer warranty (SICK general terms of delivery). • Duration: Five-year warranty from delivery date. 	Extended warranty for a total of five years from delivery date	1680671

SICK AT A GLANCE

SICK is one of the leading manufacturers of intelligent sensors and sensor solutions for industrial applications. A unique range of products and services creates the perfect basis for controlling processes securely and efficiently, protecting individuals from accidents and preventing damage to the environment.

We have extensive experience in a wide range of industries and understand their processes and requirements. With intelligent sensors, we can deliver exactly what our customers need. In application centers in Europe, Asia and North America, system solutions are tested and optimized in accordance with customer specifications. All this makes us a reliable supplier and development partner.

Comprehensive services complete our offering: SICK LifeTime Services provide support throughout the machine life cycle and ensure safety and productivity.

For us, that is “Sensor Intelligence.”

WORLDWIDE PRESENCE:

Contacts and other locations –www.sick.com