



# NAV310-3211

NAV3xx

2D LIDAR SENSORS

**SICK**  
Sensor Intelligence.



### Ordering information

Type	Part no.
NAV310-3211	1060834

Other models and accessories → [www.sick.com/NAV3xx](http://www.sick.com/NAV3xx)



### Detailed technical data

#### Features

<b>Task</b>	Localizing, navigating and guiding - Localizing Determining position - 2D position determination
<b>Application</b>	Indoor
<b>Light source</b>	905 nm
<b>Laser class</b>	1 (IEC 60825-1:2014, EN 60825-1:2014)
<b>Aperture angle</b>	Horizontal 360°
<b>Scanning frequency</b>	5 Hz ... 20 Hz
<b>Angular resolution</b>	0.125°, 1.875°, 0.25°, 0.375°, 0.5°, 0.75°, 1°, Interlaced: 0,0625
<b>Working range</b>	0.5 m ... 250 m
<b>Scanning range</b>	At 10% remission factor 35 m At 90% remission factor 120 m

#### Mechanics/electronics

<b>Connection type</b>	3 x M12 male connector/female connector
<b>Supply voltage</b>	24 V DC, ± 15 %
<b>Power consumption</b>	36 W
<b>Housing material</b>	Aluminum die cast
<b>Housing color</b>	Light blue (RAL 5012)
<b>Enclosure rating</b>	IP65
<b>Protection class</b>	III
<b>Weight</b>	2.4 kg
<b>Dimensions (L x W x H)</b>	115 mm x 120.5 mm x 222 mm
<b>MTBF</b>	86 years

#### Safety-related parameters

<b>MTTF<sub>D</sub></b>	> 100 years
-------------------------	-------------

## Performance

<b>Detectable object shape</b>	Almost any
<b>Systematic error</b>	$\pm 10 \text{ mm}^{1)}$
<b>Statistical error</b>	$15 \text{ mm}^{1)}$

<sup>1)</sup> Actual value depends on environmental conditions.

## Interfaces

<b>Ethernet</b>	✓, TCP/IP
Data transmission rate	100 Mbit/s
<b>Serial</b>	✓, RS-232
Data transmission rate	19.2 kBaud ... 115 kBaud
<b>Digital outputs</b>	1 (digital)
<b>Optical indicators</b>	4 LEDs (status displays)

## Ambient data

<b>Ambient operating temperature</b>	0 °C ... +50 °C
<b>Storage temperature</b>	-20 °C ... +80 °C
<b>Permissible relative humidity</b>	85 %, Non-condensing

## General notes

<b>Note on use</b>	The sensor does not constitute a safety component as defined by relevant legislation on machine safety.
--------------------	---

## Classifications

<b>ECLASS 5.0</b>	27270990
<b>ECLASS 5.1.4</b>	27270990
<b>ECLASS 6.0</b>	27270913
<b>ECLASS 6.2</b>	27270913
<b>ECLASS 7.0</b>	27270913
<b>ECLASS 8.0</b>	27270913
<b>ECLASS 8.1</b>	27270913
<b>ECLASS 9.0</b>	27270913
<b>ECLASS 10.0</b>	27270913
<b>ECLASS 11.0</b>	27270913
<b>ECLASS 12.0</b>	27270913
<b>ETIM 5.0</b>	EC002550
<b>ETIM 6.0</b>	EC002550
<b>ETIM 7.0</b>	EC002550
<b>ETIM 8.0</b>	EC002550
<b>UNSPSC 16.0901</b>	41111615

Dimensional drawing (Dimensions in mm (inch))

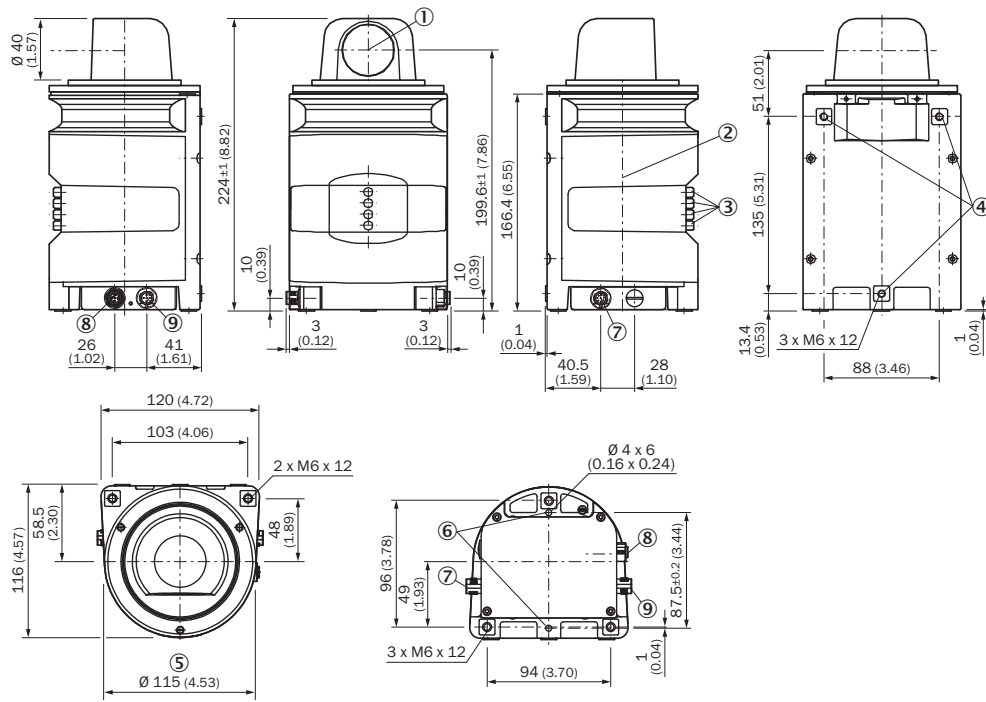

- ① Optical axis
- ② Zero level
- ③ LED (from top: yellow, yellow, green, red)
- ④ Mounting hole M6 x 12
- ⑤ Rotating diameter
- ⑥ Aligning pin
- ⑦ RS-232 connection (M12 x 8, male connector)
- ⑧ Ethernet connection (M12 x 4, female connector)
- ⑨ Power supply connection (M12 x 5, male connector)

### Working range diagram

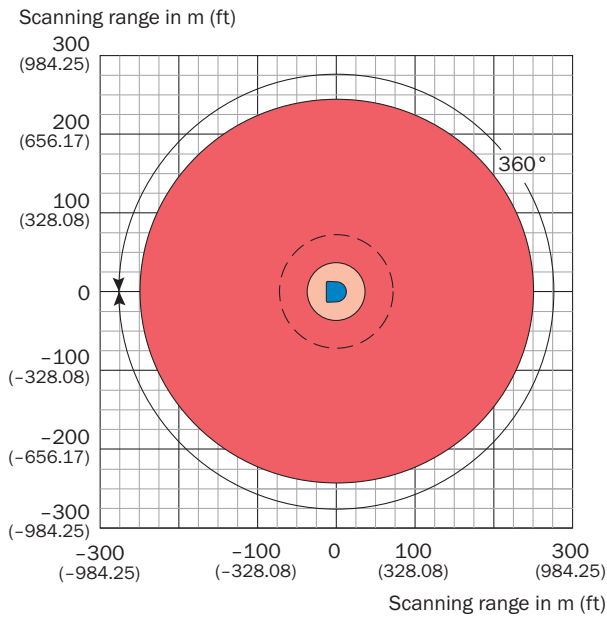



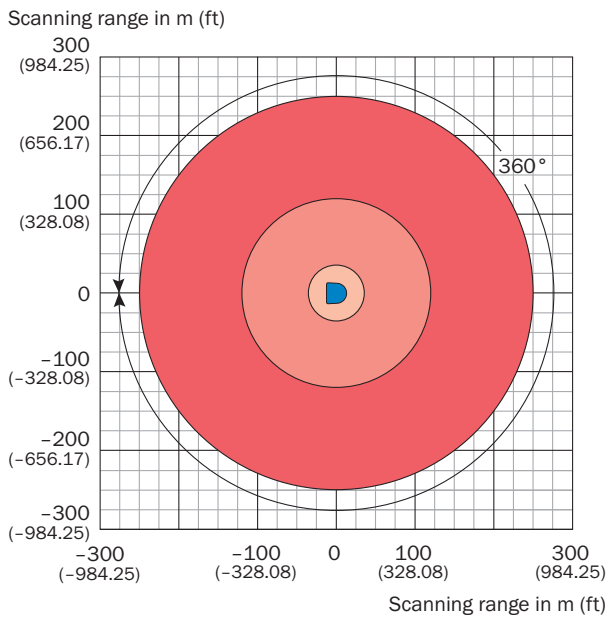

- Scanning range max. 250 m (820.21 ft)
- Scanning range for objects up to 10 % remission 35 m (114.83 ft)
- Scanning range on reflector 70 m (229.66 ft)



- Scanning range max. 250 m (820.21 ft)
- Scanning range white targets 90 % remission 120 m (393.70 ft)
- Scanning range for objects up to 10 % remission 35 m (114.83 ft)

### Recommended accessories

Other models and accessories → [www.sick.com/NAV3xx](http://www.sick.com/NAV3xx)

	Brief description	Type	Part no.
<b>Reflectors</b>			
	Reflective tape "Diamond Grade", self-adhesive, sheet, 749 mm x 914 mm, self-adhesive	REF-DG	5320565
<b>Others</b>			
	<ul style="list-style-type: none"> <li>• <b>Connection type head A:</b> Female connector, M12, 5-pin, straight</li> <li>• <b>Connection type head B:</b> Flying leads</li> <li>• <b>Signal type:</b> Sensor/actuator cable</li> <li>• <b>Cable:</b> 5 m, 5-wire, PUR, halogen-free</li> <li>• <b>Description:</b> Sensor/actuator cable, shielded</li> <li>• <b>Connection systems:</b> Flying leads</li> <li>• <b>Application:</b> Zones with oils and lubricants, Drag chain operation</li> </ul>	DOL-1205-G05MAC25	6043440
	<ul style="list-style-type: none"> <li>• <b>Connection type head A:</b> Male connector, M12, 4-pin, straight, D-coded</li> <li>• <b>Connection type head B:</b> Male connector, RJ45, 4-pin, straight</li> <li>• <b>Signal type:</b> Ethernet, PROFINET</li> <li>• <b>Cable:</b> 5 m, 4-wire, PUR, halogen-free</li> <li>• <b>Description:</b> Ethernet, PROFINET, shielded</li> <li>• <b>Application:</b> Drag chain operation, Zones with oils and lubricants</li> </ul>	YM2D24-050PN1MRJA4	2106184
	<ul style="list-style-type: none"> <li>• <b>Connection type head A:</b> Female connector, M12, 8-pin, straight, A-coded</li> <li>• <b>Connection type head B:</b> Flying leads</li> <li>• <b>Signal type:</b> Sensor/actuator cable</li> <li>• <b>Cable:</b> 5 m, 8-wire, PUR, halogen-free</li> <li>• <b>Description:</b> Sensor/actuator cable, shielded</li> <li>• <b>Application:</b> Zones with oils and lubricants, Drag chain operation</li> </ul>	YF2A28-050UA6XLEAX	2095835

### Recommended services

Additional services → [www.sick.com/NAV3xx](http://www.sick.com/NAV3xx)

	Type	Part no.
<b>Commissioning</b>		
<ul style="list-style-type: none"> <li>• <b>Product area:</b> 2D LiDAR sensors, 3D LiDAR sensors</li> <li>• <b>Range of services:</b> Inspection of connection, fine adjustment, configuration of monitored areas, configuration and optimization of parameters as well as tests, Setup of previously defined functions of basic settings, parameters of field application, filters for raw data output and product-specific configuration</li> <li>• <b>Duration:</b> Additional work will be invoiced separately</li> </ul>	Commissioning LiDAR sensors	1680672
<b>Maintenance</b>		
<ul style="list-style-type: none"> <li>• <b>Product area:</b> 2D LiDAR sensors, 3D LiDAR sensors</li> <li>• <b>Range of services:</b> Inspection, analysis and restoring of defined functions, Inspection and adaptation of basic settings, parameters of field application, filters for raw data output, and product-specific configuration</li> <li>• <b>Duration:</b> Additional work will be invoiced separately</li> </ul>	Maintenance of LiDAR sensors	1682593
<b>Extended warranty</b>		
<ul style="list-style-type: none"> <li>• <b>Product area:</b> Machine vision, LiDAR sensors, safety camera sensors, Safety laser scanners, Safety radar sensors, Radar sensors, Fixed mount barcode scanners, Image-based code readers, RFID, Mobile handheld scanners</li> <li>• <b>Range of services:</b> The services correspond to the scope of the statutory manufacturer warranty (SICK general terms of delivery).</li> <li>• <b>Duration:</b> Five-year warranty from delivery date.</li> </ul>	Extended warranty for a total of five years from delivery date	1680671

## SICK AT A GLANCE

SICK is one of the leading manufacturers of intelligent sensors and sensor solutions for industrial applications. A unique range of products and services creates the perfect basis for controlling processes securely and efficiently, protecting individuals from accidents and preventing damage to the environment.

We have extensive experience in a wide range of industries and understand their processes and requirements. With intelligent sensors, we can deliver exactly what our customers need. In application centers in Europe, Asia and North America, system solutions are tested and optimized in accordance with customer specifications. All this makes us a reliable supplier and development partner.

Comprehensive services complete our offering: SICK LifeTime Services provide support throughout the machine life cycle and ensure safety and productivity.

For us, that is “Sensor Intelligence.”

## WORLDWIDE PRESENCE:

Contacts and other locations –[www.sick.com](http://www.sick.com)