



# DT35-B15851

Dx35

MID RANGE DISTANCE SENSORS

**SICK**  
Sensor Intelligence.



### Ordering information

Type	Part no.
DT35-B15851	1057653

Other models and accessories → [www.sick.com/Dx35](http://www.sick.com/Dx35)



### Detailed technical data

#### Mechanics/electronics

<b>Supply voltage <math>V_s</math></b>	DC 12 V ... 30 V <sup>1) 2)</sup>
<b>Ripple</b>	$\leq 5 V_{pp}$ <sup>3)</sup>
<b>Power consumption</b>	$\leq 1.7 W$ <sup>4)</sup>
<b>Initialization time</b>	$\leq 500$ ms
<b>Warm-up time</b>	$\leq 20$ min
<b>Housing material</b>	Plastic (ABS/PC)
<b>Window material</b>	Plastic (PMMA)
<b>Connection type</b>	Male connector, M12, 5-pin
<b>Indication</b>	LEDs
<b>Weight</b>	65 g
<b>Dimensions (W x H x D)</b>	32 mm x 58.67 mm x 42.7 mm
<b>Enclosure rating</b>	IP65 IP67
<b>Protection class</b>	III

<sup>1)</sup> Limit values, reverse-polarity protected, operation in short-circuit protected network: max. 8 A.

<sup>2)</sup> When using IO-Link output  $V_s > 18$  V. When using analog voltage output  $V_s > 13$  V.

<sup>3)</sup> May not fall short of or exceed  $V_s$  tolerances.

<sup>4)</sup> Without load, at +20 °C.

#### Safety-related parameters

<b>MTTF<sub>D</sub></b>	101 years
-------------------------	-----------

## Performance

<b>Measurement range min ... max:</b>	50 mm ... 12,000 mm, 90% remission factor <sup>1) 2)</sup> 50 mm ... 5,300 mm, 18 % remission 50 mm ... 3,100 mm, 6% remission factor
<b>Target</b>	Natural objects
<b>Resolution</b>	0.1 mm
<b>Repeatability</b>	≥ 0.5 mm <sup>2) 3) 4)</sup>
<b>Measurement accuracy</b>	Typ. ± 10 mm <sup>4)</sup>
<b>Response time</b>	2.5 ms ... 96.5 ms, 2.5 ms / 6.5 ms / 12.5 ms / 24.5 ms / 96.5 ms <sup>5) 6)</sup>
<b>Switching frequency</b>	333 Hz / 100 Hz / 50 Hz / 25 Hz / 6 Hz <sup>5) 6)</sup>
<b>Output time</b>	1 ms ... 32 ms, 1 ms/2 ms/4 ms/8 ms/32 ms <sup>5) 7)</sup>
<b>Light source</b>	Laser, infrared <sup>8)</sup> Infrared light
<b>Laser class</b>	1 (IEC 60825-1:2014, EN 60825-1:2014)
<b>Typ. light spot size (distance)</b>	15 mm x 15 mm (at 2 m)
<b>Additional function</b>	Set speed: Super Fast ... Super Slow, teach-in of analog output and invertible analog output, Output Q <sub>2</sub> adaptable: Current output / Voltage output / Digital output, Switching mode: Distance to Object (DtO) / switching window / object between sensor and background (ObSB), teach-in of digital output and digital output invertible, Multifunctional input: laser off / external teach / deactivated, reset to factory default
<b>Average laser service life (at 25 °C)</b>	100,000 h

<sup>1)</sup> For speed setting Slow.

<sup>2)</sup> See repeatability characteristic lines.

<sup>3)</sup> Equivalent to 1 σ.

<sup>4)</sup> 6% ... 90% remission factor.

<sup>5)</sup> Depending on the set speed: Super Fast ... Super Slow.

<sup>6)</sup> Lateral entry of the object into the measuring range.

<sup>7)</sup> Continuous change of distance in measuring range.

<sup>8)</sup> Wavelength: 827 nm; max. output: 130 mW; pulse duration: 3.5 ns; duty cycle: 1/250.

## Interfaces

<b>IO-Link</b>	✓, IO-Link V1.1
Function	Process data, parameterization, diagnosis
Data transmission rate	38.4 kbit/s
<b>Digital output</b>	
Number	1 ... 2 <sup>1) 2)</sup>
Type	Push-pull: PNP/NPN
Function	Output Q <sub>2</sub> adaptable: Current output / Voltage output / Digital output
Maximum output current I <sub>A</sub>	≤ 100 mA
<b>Analog output</b>	
Number	1
Type	Current output / voltage output
Function	Output Q <sub>2</sub> adaptable: Current output / Voltage output / Digital output

<sup>1)</sup> Output Q short-circuit protected.

<sup>2)</sup> Voltage drop < 3 V.

<sup>3)</sup> Response time ≤ 60 ms.

<sup>4)</sup> Configurable via IO-Link.

	Current	4 mA ... 20 mA, $\leq 450 \Omega$
	Voltage	0 V ... 10 V, $\geq 50,000 \Omega$
	Resolution	12 bit
<b>Multifunctional input (MF)</b>		$1 \times$ <sup>3)</sup>
<b>Hysteresis</b>		0 mm ... 11,950 mm <sup>4)</sup>

<sup>1)</sup> Output Q short-circuit protected.

<sup>2)</sup> Voltage drop < 3 V.

<sup>3)</sup> Response time  $\leq 60$  ms.

<sup>4)</sup> Configurable via IO-Link.

## Ambient data

<b>Ambient temperature, operation</b>	-30 °C ... +55 °C, $U_v \leq 24$ V
<b>Ambient temperature, storage</b>	-40 °C ... +75 °C
<b>Max. rel. humidity (not condensing)</b>	$\leq 95$ %
<b>Typ. Ambient light immunity</b>	40,000 lx
<b>Vibration resistance</b>	EN 60068-2-6, EN 60068-2-64
<b>Shock resistance</b>	EN 60068-2-27

## Classifications

<b>ECLASS 5.0</b>	27270801
<b>ECLASS 5.1.4</b>	27270801
<b>ECLASS 6.0</b>	27270801
<b>ECLASS 6.2</b>	27270801
<b>ECLASS 7.0</b>	27270801
<b>ECLASS 8.0</b>	27270801
<b>ECLASS 8.1</b>	27270801
<b>ECLASS 9.0</b>	27270801
<b>ECLASS 10.0</b>	27270801
<b>ECLASS 11.0</b>	27270801
<b>ECLASS 12.0</b>	27270916
<b>ETIM 5.0</b>	EC001825
<b>ETIM 6.0</b>	EC001825
<b>ETIM 7.0</b>	EC001825
<b>ETIM 8.0</b>	EC001825
<b>UNSPSC 16.0901</b>	41111613

**Dimensional drawing** (Dimensions in mm (inch))

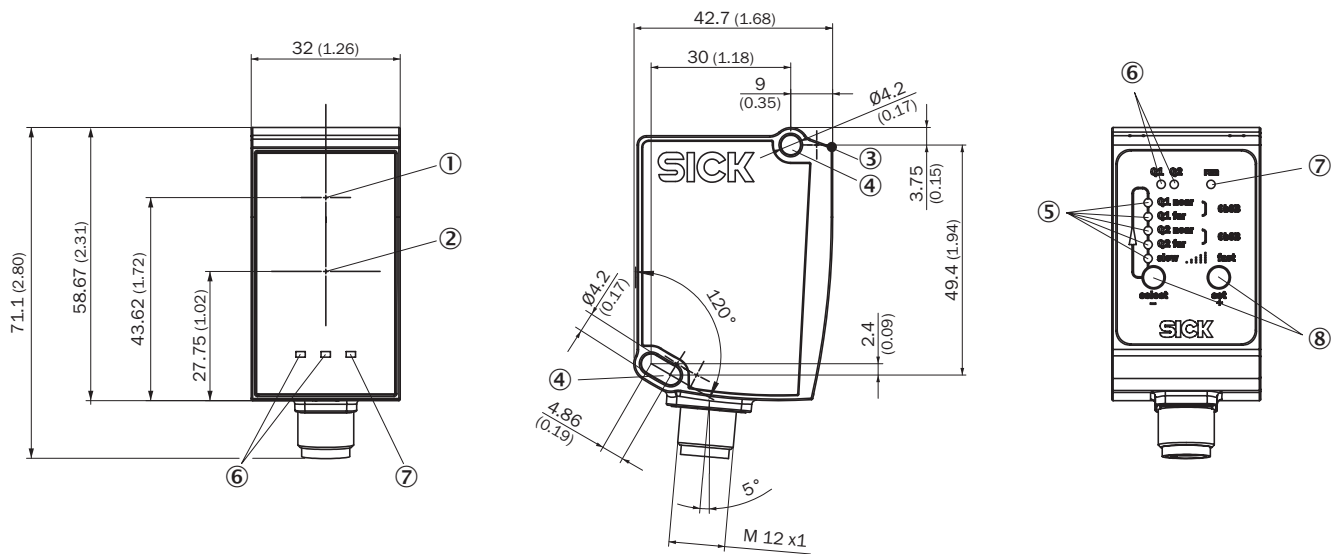

- ① Optical axis, sender
- ② Optical axis, receiver
- ③ Zero level
- ④ Mounting hole M4
- ⑤ Status indicator output Qa/Q2
- ⑥ Status LEDs output Q1
- ⑦ Operating indicator
- ⑧ Control elements

**Connection type**

Male connector M12, 5-pin

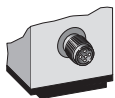

**Connection diagram**

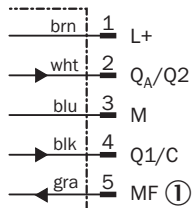

- ① Multifunctional input (MF)

**Repeatability**

Characteristic curve 1) Super Slow

**Super Slow**

Repeatability in mm (inch)

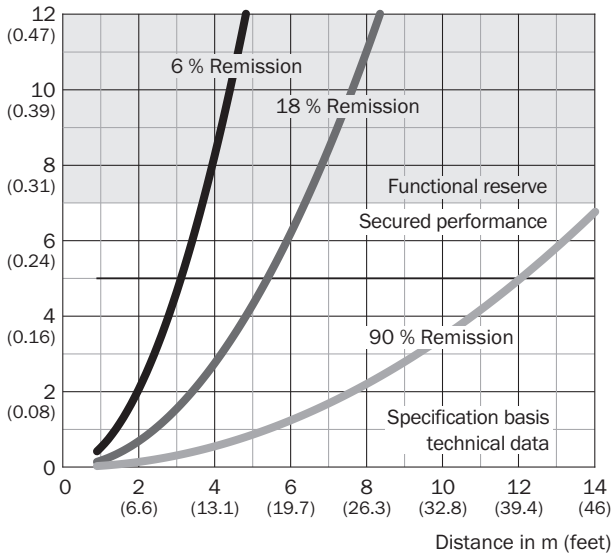

Characteristic curve 5) Super Fast

**Super Fast**

Repeatability in mm (inch)

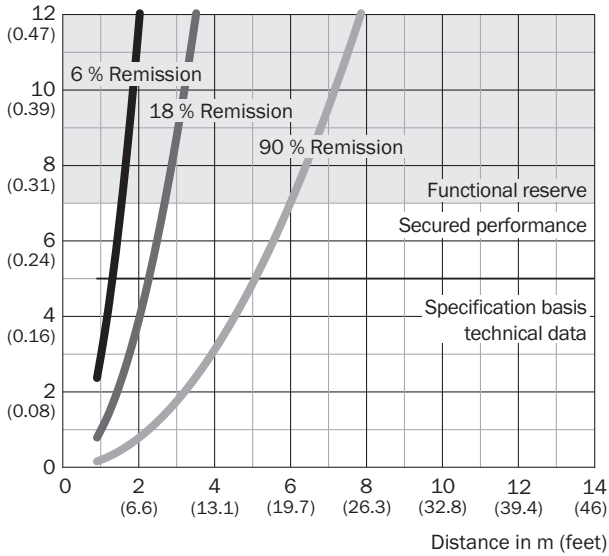

Characteristic curve 2) Slow

**Slow**

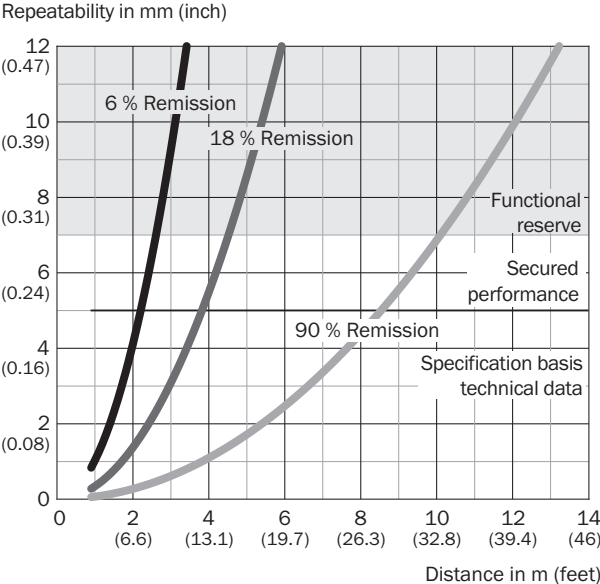

Characteristic curve 3) Medium

**Medium**

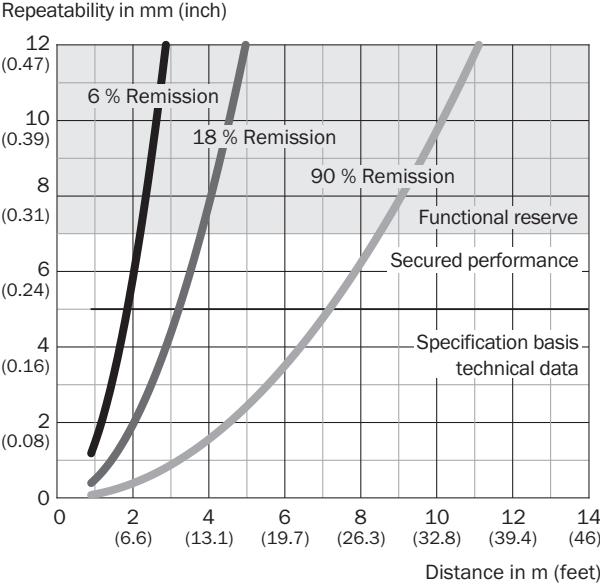

Characteristic curve 4) Fast



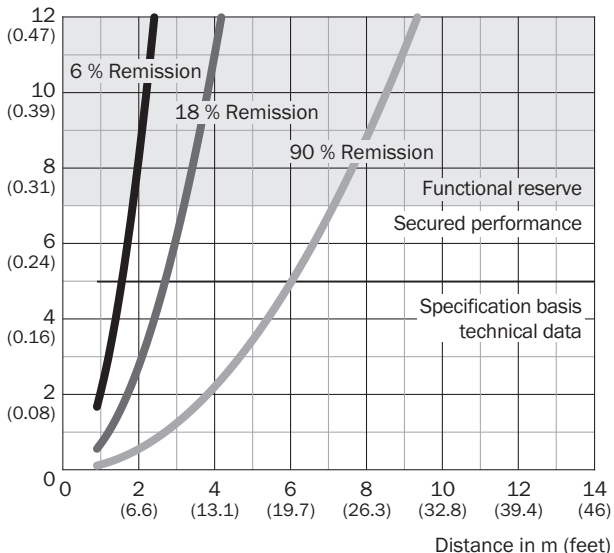

**Fast**

Repeatability in mm (inch)





**Recommended accessories**

Other models and accessories → [www.sick.com/Dx35](http://www.sick.com/Dx35)

	<b>Brief description</b>	<b>Type</b>	<b>Part no.</b>
<b>Universal bar clamp systems</b>			
	Plate N02 for universal clamp bracket, Zinc plated steel (sheet), Zinc die cast (clamping bracket), Universal clamp (5322626), mounting hardware	BEF-KHS-N02	2051608
<b>Mounting brackets and plates</b>			
	Mounting bracket: horizontal sending axis for ceiling or floor installation or vertical sending axis for wall installation, steel, zinc coated, incl. mounting material, steel, zinc coated, mounting hardware for the sensor included	BEF-WN-DX35	2069592
<b>Terminal and alignment brackets</b>			
	Alignment unit, steel, zinc coated, mounting hardware for the sensor included	BEF-AH-DX50	2048397
<b>Others</b>			
	<ul style="list-style-type: none"> <li>• <b>Connection type head A:</b> Female connector, M12, 5-pin, straight, A-coded</li> <li>• <b>Connection type head B:</b> Male connector, M12, 5-pin, straight, A-coded</li> <li>• <b>Signal type:</b> Sensor/actuator cable</li> <li>• <b>Cable:</b> 2 m, 5-wire, PUR, halogen-free</li> <li>• <b>Description:</b> Sensor/actuator cable, unshielded</li> <li>• <b>Application:</b> Zones with oils and lubricants, Drag chain operation, Robot</li> </ul>	YF2A15-020UB5M2A15	2096009



	Brief description	Type	Part no.
	<ul style="list-style-type: none"> <li>• <b>Connection type head A:</b> Female connector, M12, 5-pin, angled, A-coded</li> <li>• <b>Connection type head B:</b> Flying leads</li> <li>• <b>Signal type:</b> Sensor/actuator cable</li> <li>• <b>Cable:</b> 2 m, 5-wire, PVC</li> <li>• <b>Description:</b> Sensor/actuator cable, unshielded</li> <li>• <b>Application:</b> Zones with chemicals</li> </ul>	YG2A15-020VB5XLEAX	2096215
	<ul style="list-style-type: none"> <li>• <b>Connection type head A:</b> Female connector, M12, 5-pin, straight, A-coded</li> <li>• <b>Connection type head B:</b> Flying leads</li> <li>• <b>Signal type:</b> Sensor/actuator cable</li> <li>• <b>Cable:</b> 2 m, 5-wire, PVC</li> <li>• <b>Description:</b> Sensor/actuator cable, unshielded</li> <li>• <b>Application:</b> Zones with chemicals</li> </ul>	YF2A15-020VB5XLEAX	2096239

## SICK AT A GLANCE

SICK is one of the leading manufacturers of intelligent sensors and sensor solutions for industrial applications. A unique range of products and services creates the perfect basis for controlling processes securely and efficiently, protecting individuals from accidents and preventing damage to the environment.

We have extensive experience in a wide range of industries and understand their processes and requirements. With intelligent sensors, we can deliver exactly what our customers need. In application centers in Europe, Asia and North America, system solutions are tested and optimized in accordance with customer specifications. All this makes us a reliable supplier and development partner.

Comprehensive services complete our offering: SICK LifeTime Services provide support throughout the machine life cycle and ensure safety and productivity.

For us, that is “Sensor Intelligence.”

## WORLDWIDE PRESENCE:

Contacts and other locations –[www.sick.com](http://www.sick.com)