



# RFU620-10501

RFU62x

RFID

**SICK**  
Sensor Intelligence.



### Ordering information

| Type         | Part no. |
|--------------|----------|
| RFU620-10501 | 1062604  |

Other models and accessories → [www.sick.com/RFU62x](http://www.sick.com/RFU62x)



### Detailed technical data

#### Features

|                          |                                                                                                                                                                                                           |
|--------------------------|-----------------------------------------------------------------------------------------------------------------------------------------------------------------------------------------------------------|
| <b>Task</b>              | Identifying - RFID transponder                                                                                                                                                                            |
| <b>Version</b>           | Mid Range                                                                                                                                                                                                 |
| <b>Product category</b>  | RFID read/write device with integrated antenna                                                                                                                                                            |
| <b>Radio approval</b>    | USA (FCC Part 15.247)<br>Canada (RSS-210)<br>México (NOM-121)                                                                                                                                             |
| <b>Frequency band</b>    | UHF (860 MHz ... 960 MHz)                                                                                                                                                                                 |
| <b>Carrier frequency</b> | 902.75 MHz ... 927.25 MHz                                                                                                                                                                                 |
| <b>Output power</b>      | 0.32 W (EIRP, 25 dBm)                                                                                                                                                                                     |
| <b>RFID standard</b>     | EPCglobal UHF Class 1 Generation 2, ISO/IEC 18000-6 C                                                                                                                                                     |
| <b>Modulation</b>        | PR-ASK                                                                                                                                                                                                    |
| <b>Connection type</b>   | PoE                                                                                                                                                                                                       |
| <b>Aperture angle</b>    | 100°                                                                                                                                                                                                      |
| <b>Heating</b>           | No                                                                                                                                                                                                        |
| <b>Read range</b>        | ≤ 2 m <sup>1)</sup>                                                                                                                                                                                       |
| <b>Antenna</b>           | Integrated                                                                                                                                                                                                |
| Transmitting power       | Adjustable                                                                                                                                                                                                |
| Polarization             | Circular                                                                                                                                                                                                  |
| Axial ratio              | Typ. 3 dB                                                                                                                                                                                                 |
| Front-to-back ratio      | > 5 dB                                                                                                                                                                                                    |
| <b>Further functions</b> | Diagnosis, updatable firmware, freely programmable data output format, Heartbeat, triggering, SICK AppSpace functionalities can be enabled with the SD card accessory SDK6U-P00100 (for firmware ≥ 2.0.0) |

<sup>1)</sup> Depending on transponder used and ambient conditions.

## Mechanics/electronics

|                               |                                                                        |
|-------------------------------|------------------------------------------------------------------------|
| <b>Connection type</b>        | 1, 1 x M12, 8-pin female connector, X-coded, USB, 5-pin micro-B socket |
| <b>Supply voltage</b>         | 48 V DC ... 57 V DC <sup>1)</sup>                                      |
| <b>Power consumption</b>      | Typ. 8 W, standby 3 W                                                  |
| <b>Housing</b>                | Aluminum die cast<br>Plastic (PPS)                                     |
| <b>Enclosure rating</b>       | IP67                                                                   |
| <b>Protection class</b>       | III                                                                    |
| <b>Weight</b>                 | 780 g                                                                  |
| <b>Dimensions (L x W x H)</b> | 137 mm x 131 mm x 56 mm                                                |
| <b>MTBF</b>                   | > 100 years                                                            |

<sup>1)</sup> According to PoE technology.

## Interfaces

|                               |                                                                                   |
|-------------------------------|-----------------------------------------------------------------------------------|
| <b>Ethernet</b>               | ✓, TCP/IP, PoE, OPC UA                                                            |
| Remark                        | Companion Spec V1.0 from firmware 2.20                                            |
| Function                      | Data interface (read result output), Service interface, PoE                       |
| Data transmission rate        | 10/100 MBit/s                                                                     |
| <b>PROFINET</b>               | ✓                                                                                 |
| Function                      | PROFINET Single Port, Data interface (read result output)                         |
| Data transmission rate        | 10/100 MBit/s                                                                     |
| <b>EtherNet/IP™</b>           | ✓                                                                                 |
| Function                      | Data interface (read result output)                                               |
| Data transmission rate        | 10/100 MBit/s                                                                     |
| <b>USB</b>                    | ✓                                                                                 |
| Remark                        | USB 2.0                                                                           |
| Function                      | Service interface                                                                 |
| <b>Digital inputs</b>         | 0                                                                                 |
| <b>Digital outputs</b>        | 0                                                                                 |
| <b>Optical indicators</b>     | 7 LEDs, multi-color (device status)<br>4 RGB LED (Process feedback)               |
| <b>Operator interfaces</b>    | Web server                                                                        |
| <b>Configuration software</b> | SOPAS ET <sup>1)</sup>                                                            |
| <b>Programming interface</b>  | Application-specific programming using the SICK AppStudio development environment |
| <b>Memory card</b>            | microSD memory card (parameter cloning, data storage)                             |

<sup>1)</sup> Another alternative is to generate your own configuration tools based on the SICK command language CoLa (e.g. in your own software or on PLC function blocks).

## Ambient data

|                                            |                       |
|--------------------------------------------|-----------------------|
| <b>Electromagnetic compatibility (EMC)</b> | EN 301489-3           |
| <b>Vibration resistance</b>                | EN 60068-2-64:2008-02 |
| <b>Shock resistance</b>                    | EN 60068-2-27:2009-05 |
| <b>Ambient operating temperature</b>       | -25 °C ... +50 °C     |
| <b>Storage temperature</b>                 | -40 °C ... +70 °C     |
| <b>Permissible relative humidity</b>       | 90 %, Non-condensing  |

### Classifications

|                       |          |
|-----------------------|----------|
| <b>ECLASS 5.0</b>     | 27280401 |
| <b>ECLASS 5.1.4</b>   | 27280401 |
| <b>ECLASS 6.0</b>     | 27280401 |
| <b>ECLASS 6.2</b>     | 27280401 |
| <b>ECLASS 7.0</b>     | 27280401 |
| <b>ECLASS 8.0</b>     | 27280401 |
| <b>ECLASS 8.1</b>     | 27280401 |
| <b>ECLASS 9.0</b>     | 27280401 |
| <b>ECLASS 10.0</b>    | 27280401 |
| <b>ECLASS 11.0</b>    | 27280401 |
| <b>ECLASS 12.0</b>    | 27280401 |
| <b>ETIM 6.0</b>       | EC002998 |
| <b>ETIM 7.0</b>       | EC002998 |
| <b>ETIM 8.0</b>       | EC002998 |
| <b>UNSPSC 16.0901</b> | 52161523 |

## Dimensional drawing (Dimensions in mm (inch))

## Dimensional drawing RFU62x

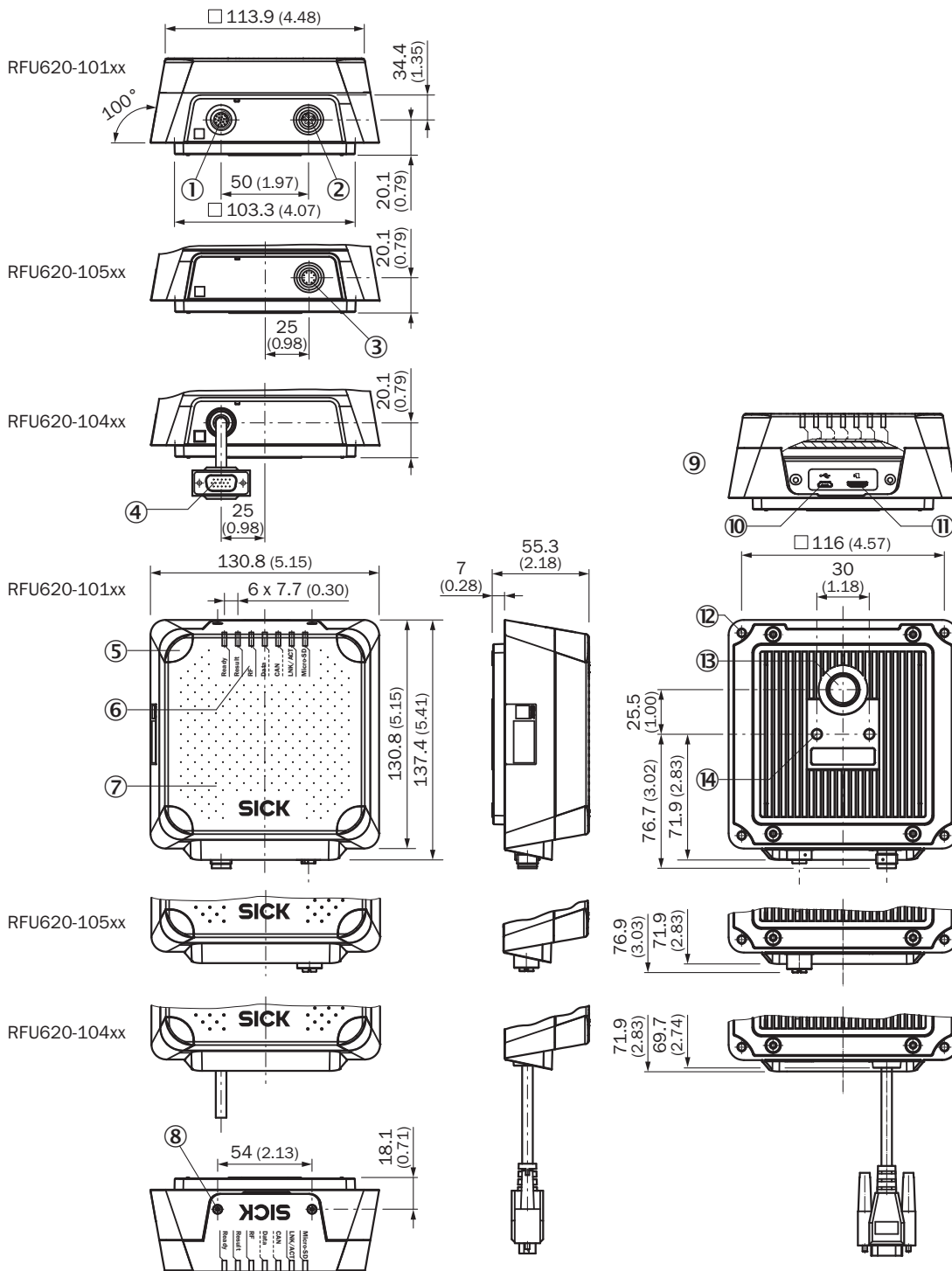

- ① "Power/AUX/CAN/I/O" connection, 17-pin M12 male connector, A-coded
- ② "Ethernet" connection, 4-pin M12 female connector, D-coded
- ③ "Ethernet" connection, 8-pin M12 female connector, X-coded
- ④ "Power/HOST/AUX/CAN/I/O" connection, 15-pin D-Sub HD male connector, cable 0,9 m
- ⑤ 4 x LED, multi-colored (process feedback)
- ⑥ 7 x LED for status display
- ⑦ Cover with integrated antenna
- ⑧ Screw (Torx T8), captive (2 x), for side cover
- ⑨ Side cover opened
- ⑩ USB socket, type Micro-B
- ⑪ Slot for microSD memory card
- ⑫ Blind hole thread M5, 9 mm deep (4 x), for alternatively mounting
- ⑬ Pressure compensation valve (ventilation element)
- ⑭ M6 blind tapped holes, 7 mm deep (2 x), for mounting

### Radiation pattern



Measured antenna gain in dBic at 868.5 MHz, RHCP (right-hand circularly polarized)

- ① Horizontal plane (azimuth)
- ② Vertical plane (elevation)

### Connection diagram

PROFINET IO/RT

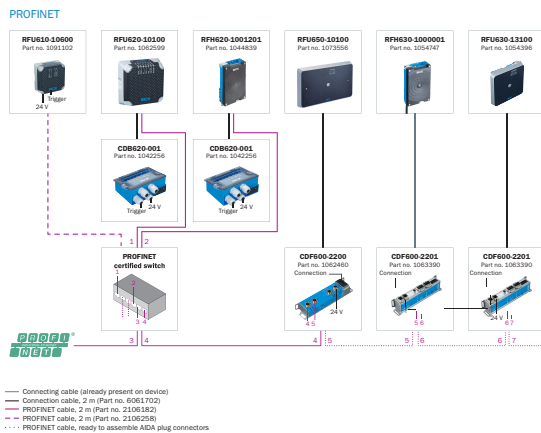

EtherCAT®

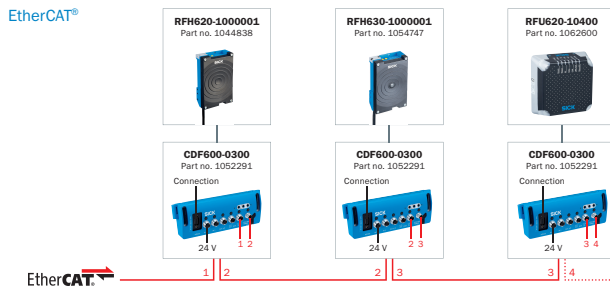

— Connecting cable (already present on device)  
 — EtherCAT® cable, 2 m (Part no. 2106159)

System construction

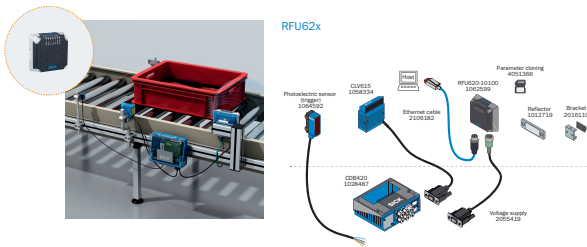

Data combination of barcode and RFID



### Overview

SICK AppSpace





### Recommended accessories

Other models and accessories → [www.sick.com/RFU62x](http://www.sick.com/RFU62x)

|                                                                                     | Brief description                                | Type                | Part no. |
|-------------------------------------------------------------------------------------|--------------------------------------------------|---------------------|----------|
| <b>Storage media</b>                                                                |                                                  |                     |          |
|  | microSD memory card with 1 GB for industrial use | microSD memory card | 4051366  |
| <b>Mounting brackets and plates</b>                                                 |                                                  |                     |          |
|  | Simple mounting bracket                          | Mounting bracket    | 2071067  |



|                                                                                   | Brief description                                                                                                                                                                                                                                                                                 | Type                                 | Part no. |
|-----------------------------------------------------------------------------------|---------------------------------------------------------------------------------------------------------------------------------------------------------------------------------------------------------------------------------------------------------------------------------------------------|--------------------------------------|----------|
| Others                                                                            |                                                                                                                                                                                                                                                                                                   |                                      |          |
|  | <ul style="list-style-type: none"> <li>• <b>Connection type head A:</b> Male connector, USB-A</li> <li>• <b>Connection type head B:</b> Male connector, Micro-B</li> <li>• <b>Signal type:</b> USB 2.0</li> <li>• <b>Cable:</b> 2 m</li> <li>• <b>Description:</b> USB 2.0, unshielded</li> </ul> | USB cable                            | 6036106  |
|  | <ul style="list-style-type: none"> <li>• <b>Carrier frequency:</b> 865 MHz ... 928 MHz</li> <li>• <b>Memory capacity (UII / user memory):</b> 128/512 Bit</li> <li>• <b>Dimensions (L x W x H):</b> 18 mm x 122 mm x 2 mm</li> </ul>                                                              | UHF Transponder, rectangular, global | 6068184  |
|  | <ul style="list-style-type: none"> <li>• <b>Carrier frequency:</b> 865 MHz ... 928 MHz</li> <li>• <b>Memory capacity (UII / user memory):</b> 496/128 Bit</li> <li>• <b>Dimensions (L x W x H):</b> 18 mm x 122 mm x 2 mm</li> </ul>                                                              | UHF Transponder, Rectangular, global | 6088050  |

## Recommended services

Additional services → [www.sick.com/RFU62x](http://www.sick.com/RFU62x)

|                                                                                                                                                                                                                                                                                                                                                                                                                                              | Type                                                           | Part no. |
|----------------------------------------------------------------------------------------------------------------------------------------------------------------------------------------------------------------------------------------------------------------------------------------------------------------------------------------------------------------------------------------------------------------------------------------------|----------------------------------------------------------------|----------|
| Commissioning                                                                                                                                                                                                                                                                                                                                                                                                                                |                                                                |          |
| <ul style="list-style-type: none"> <li>• <b>Product area:</b> RFID</li> <li>• <b>Range of services:</b> Inspection of connection, alignment, optimization of parameters of the RFU/RFH as well as tests, Setup of previously defined functions of reading configuration, data processing and network, interfaces and inputs and outputs</li> <li>• <b>Duration:</b> Additional work will be invoiced separately</li> </ul>                   | Commissioning RFU/RFH                                          | 1610018  |
| Maintenance                                                                                                                                                                                                                                                                                                                                                                                                                                  |                                                                |          |
| <ul style="list-style-type: none"> <li>• <b>Product area:</b> RFID</li> <li>• <b>Range of services:</b> Inspection, analysis and restoring of defined functions, Checking and adjustment of reading configuration, data processing, network, interfaces and inputs and outputs as well as operating data</li> <li>• <b>Duration:</b> Additional work will be invoiced separately</li> </ul>                                                  | Maintenance RFU/RFH                                            | 1611424  |
| Extended warranty                                                                                                                                                                                                                                                                                                                                                                                                                            |                                                                |          |
| <ul style="list-style-type: none"> <li>• <b>Product area:</b> Identification solutions, machine vision, Detection and ranging solutions, safety camera sensors, Safety laser scanners, Safety radar sensors</li> <li>• <b>Range of services:</b> The services correspond to the scope of the statutory manufacturer warranty (SICK general terms of delivery).</li> <li>• <b>Duration:</b> Five-year warranty from delivery date.</li> </ul> | Extended warranty for a total of five years from delivery date | 1680671  |

## SICK AT A GLANCE

SICK is one of the leading manufacturers of intelligent sensors and sensor solutions for industrial applications. A unique range of products and services creates the perfect basis for controlling processes securely and efficiently, protecting individuals from accidents and preventing damage to the environment.

We have extensive experience in a wide range of industries and understand their processes and requirements. With intelligent sensors, we can deliver exactly what our customers need. In application centers in Europe, Asia and North America, system solutions are tested and optimized in accordance with customer specifications. All this makes us a reliable supplier and development partner.

Comprehensive services complete our offering: SICK LifeTime Services provide support throughout the machine life cycle and ensure safety and productivity.

For us, that is “Sensor Intelligence.”

## WORLDWIDE PRESENCE:

Contacts and other locations –[www.sick.com](http://www.sick.com)