



CM30-16BAP-KW1

CM

CAPACITIVE PROXIMITY SENSORS

SICK
Sensor Intelligence.



Illustration may differ



Ordering information

Type	Part no.
CM30-16BAP-KW1	6028411

Other models and accessories → www.sick.com/CM

Detailed technical data

Features

Housing	Cylindrical thread design
Thread size	M30 x 1.5
Diameter	Ø 30 mm
Sensing range S_n	2 mm ... 16 mm
Safe sensing range S_a	11.52 mm
Installation type	Flush
Switching frequency	10 Hz
Connection type	Cable, 2-wire, 2 m ¹⁾
Output function	NC or NO
Electrical wiring	AC 2-wire
Adjustment	Potentiometer, 11 turns (Sensitivity)
Enclosure rating	IP67 (According to EN 60529)
Items supplied	Mounting nut, PA12 plastic (2x) Screwdriver for potentiometer adjustment (1 x)

¹⁾ Do not bend below 0 °C.

Mechanics/electronics

Supply voltage	20 V AC ... 250 V AC
Ripple	≤ 10 % ¹⁾
Voltage drop	≤ 10 V DC ²⁾
Current consumption	10 mA ³⁾
Time delay before availability	≤ 100 ms

¹⁾ Of U_b .

²⁾ At I_a max.

³⁾ Without load.

⁴⁾ Of S_r .

⁵⁾ Supply voltage U_b and constant ambient temperature T_a .

⁶⁾ In EMC critical applications, conducted interference levels may lie within the frequency range of the oscillator. This can cause changes to the output signal. (See operating instructions.).

Hysteresis	4 % ... 20 %
Reproducibility	≤ 5 % ^{4) 5)}
Temperature drift (of S_r)	± 10 %
EMC	According to EN 60947-5-2 ⁶⁾
Continuous current I_a	≤ 500 mA
Cable material	PVC
Conductor size	0.5 mm ²
Reverse polarity protection	✓
Power-up pulse protection	✓
Shock and vibration resistance	30 g, 11 ms / 10 ... 55 Hz, 1 mm
Ambient operating temperature	-25 °C ... +80 °C
Housing material	Plastic, PBT
Housing length	63.6 mm
Thread length	50 mm
Tightening torque, max.	≤ 7.5 Nm

1) Of Ub.

2) At I_a max.

3) Without load.

4) Of S_r.

5) Supply voltage Ub and constant ambient temperature Ta.

6) In EMC critical applications, conducted interference levels may lie within the frequency range of the oscillator. This can cause changes to the output signal. (See operating instructions.).

Safety-related parameters

MTTF_D	815 years
DC_{avg}	0 %
T_M (mission time)	20 years

Reduction factors

Note	The values are reference values which may vary
Metal	1
Water	1
PVC	Approx. 0.4
Oil	Approx. 0.25
Glass	0.6
Ceramics	0.5
Alcohol	0.7
Wood	0.2 ... 0.7

Installation note

Remark	Associated graphic see "Installation"
B	30 mm
C	30 mm
D	48 mm

Classifications

eCl@ss 5.0	27270102
eCl@ss 5.1.4	27270102
eCl@ss 6.0	27270102
eCl@ss 6.2	27270102
eCl@ss 7.0	27270102
eCl@ss 8.0	27270102
eCl@ss 8.1	27270102
eCl@ss 9.0	27270102
eCl@ss 10.0	27270102
eCl@ss 11.0	27270102
eCl@ss 12.0	27274201
ETIM 5.0	EC002715
ETIM 6.0	EC002715
ETIM 7.0	EC002715
ETIM 8.0	EC002715
UNSPSC 16.0901	39122230

Installation note

Flush installation

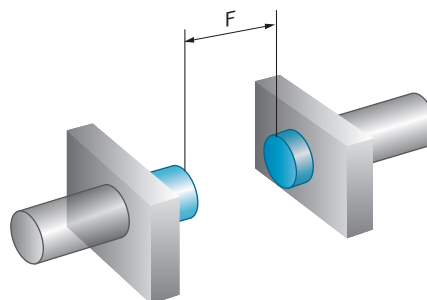
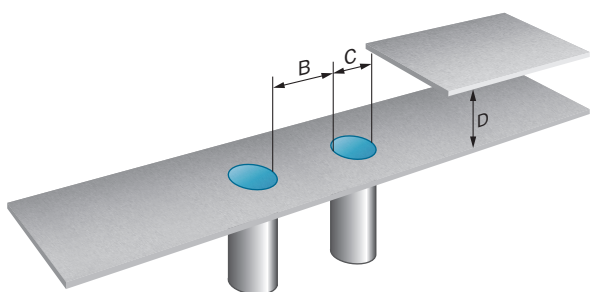

Connection diagram

Cd-013

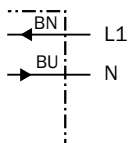

Response diagram

CM30, Flush installation

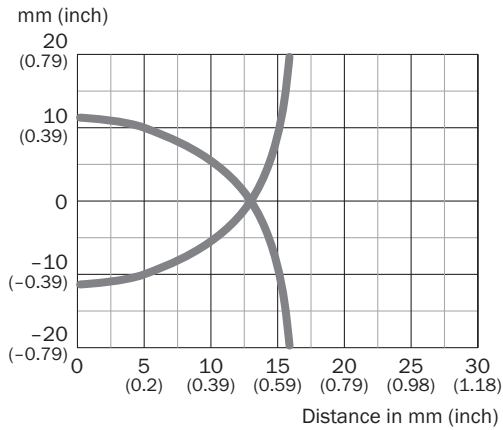

Dimensional drawing (Dimensions in mm (inch))

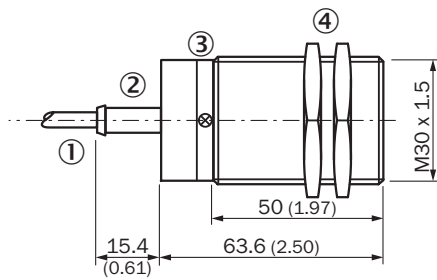

CM30, flush, cable



- ① Connection
- ② Display LED
- ③ Potentiometer for sensitivity adjustment
- ④ Fastening nuts (2 x); 34 mm hex, plastic

Recommended accessories

Other models and accessories → www.sick.com/CM

	Brief description	Type	Part no.
Mounting brackets and plates			
	Mounting plate for M30 sensors, steel, zinc coated, without mounting hardware	BEF-WG-M30	5321871
	Mounting bracket for M30 sensors, steel, zinc coated, without mounting hardware	BEF-WN-M30	5308445

SICK AT A GLANCE

SICK is one of the leading manufacturers of intelligent sensors and sensor solutions for industrial applications. A unique range of products and services creates the perfect basis for controlling processes securely and efficiently, protecting individuals from accidents and preventing damage to the environment.

We have extensive experience in a wide range of industries and understand their processes and requirements. With intelligent sensors, we can deliver exactly what our customers need. In application centers in Europe, Asia and North America, system solutions are tested and optimized in accordance with customer specifications. All this makes us a reliable supplier and development partner.

Comprehensive services complete our offering: SICK LifeTime Services provide support throughout the machine life cycle and ensure safety and productivity.

For us, that is “Sensor Intelligence.”

WORLDWIDE PRESENCE:

Contacts and other locations –www.sick.com