

DBS60E-S4CL04096

DBS60

INCREMENTAL ENCODERS

SICK
Sensor Intelligence.



Illustration may differ



Ordering information

| Type | Part no. |
|------------------|----------|
| DBS60E-S4CL04096 | 1077472 |

Other models and accessories → www.sick.com/DBS60

Detailed technical data

Safety-related parameters

| | |
|--|--|
| MTTF_D (mean time to dangerous failure) | 500 years (EN ISO 13849-1) ¹⁾ |
|--|--|

¹⁾ This product is a standard product and does not constitute a safety component as defined in the Machinery Directive. Calculation based on nominal load of components, average ambient temperature 40 °C, frequency of use 8760 h/a. All electronic failures are considered hazardous. For more information, see document no. 8015532.

Performance

| | |
|---------------------------------|---------------------------------------|
| Pulses per revolution | 4,096 |
| Measuring step | ≤ 90°, electric/pulses per revolution |
| Measuring step deviation | ± 36° / pulses per revolution |
| Error limits | Measuring step deviation x 3 |
| Duty cycle | ≤ 0.5 ± 10 % |

Interfaces

| | |
|---------------------------------------|-------------------------|
| Communication interface | Incremental |
| Communication Interface detail | TTL / RS-422 |
| Number of signal channels | 6-channel |
| Initialization time | < 5 ms ¹⁾ |
| Output frequency | + 300 kHz ²⁾ |
| Load current | ≤ 30 mA, per channel |
| Power consumption | ≤ 0.5 W (without load) |

¹⁾ Valid signals can be read once this time has elapsed.

²⁾ Up to 450 kHz on request.

Electronics

| | |
|------------------------------------|---|
| Connection type | Cable, 8-wire, universal, 3 m ¹⁾ |
| Supply voltage | 10 ... 30 V |
| Reference signal, number | 1 |
| Reference signal, position | 90°, electric, logically gated with A and B |
| Reverse polarity protection | ✓ |

¹⁾ The universal cable connection is positioned so that it is possible to lay it without bends in a radial or axial direction.

²⁾ Short-circuit opposite to another channel or GND permissible for max. 60 s. No protection signal against U_S.

Short-circuit protection of the outputs

✓²⁾

¹⁾ The universal cable connection is positioned so that it is possible to lay it without bends in a radial or axial direction.

²⁾ Short-circuit opposite to another channel or GND permissible for max. 60 s. No protection signal against U_S.

Mechanics

| | |
|---------------------------------------|--|
| Mechanical design | Solid shaft, face mount flange |
| Shaft diameter | 10 mm With face |
| Shaft length | 19 mm |
| Flange type / stator coupling | Flange with 3 x M3 and 3 x M4 |
| Weight | + 0.3 kg ¹⁾ |
| Shaft material | Stainless steel |
| Flange material | Aluminum |
| Housing material | Aluminum |
| Material, cable | PVC |
| Start up torque | + 1.2 Ncm (+20 °C) |
| Operating torque | 1.1 Ncm (+20 °C) |
| Permissible shaft loading | 100 N (radial) ²⁾ 50 N (axial) ²⁾ |
| Operating speed | 6,000 min ⁻¹ ³⁾ |
| Maximum operating speed | 9,000 min ⁻¹ ⁴⁾ |
| Moment of inertia of the rotor | 33 gcm ² |
| Bearing lifetime | 3.6 x 10 ⁹ revolutions |
| Angular acceleration | ≤ 500,000 rad/s ² |

¹⁾ Based on encoder with male connector or cable with male connector.

²⁾ Higher values are possible using limited bearing life.

³⁾ Allow for self-heating of 3.2 K per 1,000 rpm when designing the operating temperature range.

⁴⁾ Maximum speed which does not cause mechanical damage to the encoder. Impact on the service life and signal quality is possible. Please note the maximum output frequency.

Ambient data

| | |
|--------------------------------------|---|
| EMC | According to EN 61000-6-2 and EN 61000-6-3 |
| Enclosure rating | IP67, housing side (IEC 60529) IP65, shaft side (IEC 60529) |
| Permissible relative humidity | 90 % (Condensation not permitted) |
| Operating temperature range | -30 °C ... +85 °C, at more than 3,000 pulses per revolution ¹⁾ |
| Storage temperature range | -40 °C ... +100 °C, without package |
| Resistance to shocks | 250 g, 3 ms (EN 60068-2-27) |
| Resistance to vibration | 30 g, 10 Hz ... 2,000 Hz (EN 60068-2-6) |

¹⁾ These values relate to all mechanical versions including recommended accessories unless otherwise noted.

Classifications

| | |
|---------------------|----------|
| ECLASS 5.0 | 27270501 |
| ECLASS 5.1.4 | 27270501 |
| ECLASS 6.0 | 27270590 |

| | |
|-----------------------|----------|
| ECLASS 6.2 | 27270590 |
| ECLASS 7.0 | 27270501 |
| ECLASS 8.0 | 27270501 |
| ECLASS 8.1 | 27270501 |
| ECLASS 9.0 | 27270501 |
| ECLASS 10.0 | 27270501 |
| ECLASS 11.0 | 27270501 |
| ECLASS 12.0 | 27270501 |
| ETIM 5.0 | EC001486 |
| ETIM 6.0 | EC001486 |
| ETIM 7.0 | EC001486 |
| ETIM 8.0 | EC001486 |
| UNSPSC 16.0901 | 41112113 |

Dimensional drawing (Dimensions in mm (inch))



PIN assignment

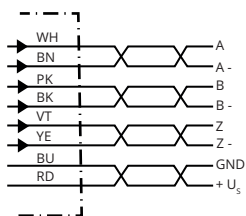

| Wire colors (cable connection) | Male connector M12, 8-pin | Male connector M23, 12-pin | TTL/HTL 6-channel signal | Explanation |
|--------------------------------|---------------------------|----------------------------|--------------------------|-------------|
| Brown | 1 | 6 | A- | Signal wire |
| White | 2 | 5 | A | Signal wire |

| Wire colors (cable connection) | Male connector M12, 8-pin | Male connector M23, 12-pin | TTL/HTL 6-channel signal | Explanation |
|--------------------------------|---------------------------|----------------------------|--------------------------|-------------------------------------|
| Black | 3 | 1 | B- | Signal wire |
| Pink | 4 | 8 | B | Signal wire |
| Yellow | 5 | 4 | Z- | Signal wire |
| Purple | 6 | 3 | Z | Signal wire |
| Blue | 7 | 10 | GND | Ground connection |
| Red | 8 | 12 | +U _s | Supply voltage |
| - | - | 9 | Not assigned | Not assigned |
| - | - | 2 | Not assigned | Not assigned |
| - | - | 11 | Not assigned | Not assigned |
| - | - | 7 | Not assigned | Not assigned |
| Screen | Screen | Screen | Screen | Screen connected to encoder housing |

Diagrams

Pulses per revolution

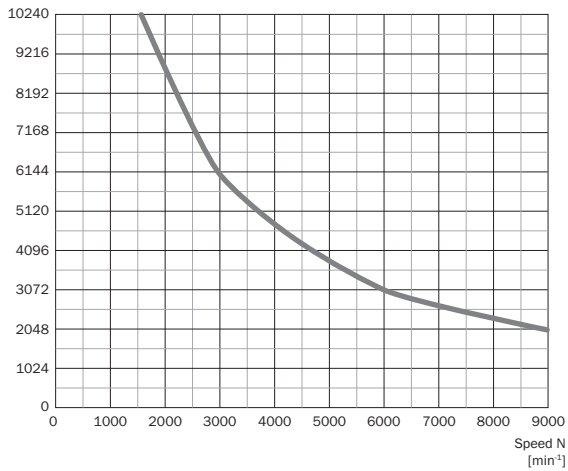

Signal outputs for electrical interfaces TTL and HTL



Cw with view on the encoder shaft in direction "A", compare dimensional drawing.

| Supply voltage | Output |
|-----------------|-------------------|
| 4,5 V ... 5,5 V | TTL |
| 10 V ... 30 V | TTL |
| 10 V ... 27 V | HTL |
| 4,5 V ... 30 V | TTL/HTL universal |
| 4,5 V ... 30 V | TTL |

Operation note



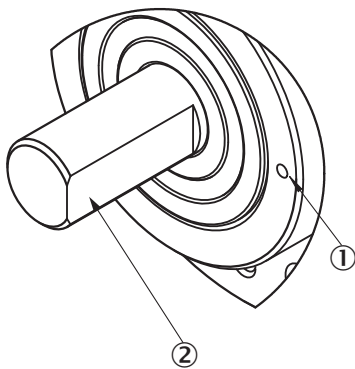



Solid shaft, face mount flange



- ① Zero pulse mark on flange
- ② Zero pulse active when the surface of the shaft shows the zero pulse mark on the flange











Recommended accessories

Other models and accessories → www.sick.com/DBS60

| | Brief description | Type | Part no. |
|---|--|----------------|----------|
| Others | | | |
|  | <ul style="list-style-type: none"> • Connection type head A: Flying leads • Connection type head B: Flying leads • Signal type: SSI, Incremental, HIPERFACE® • Items supplied: By the meter • Cable: 8-wire, PUR, halogen-free • Description: SSI, Incremental, HIPERFACE®, shielded | LTG-2308-MWENC | 6027529 |
|  | <ul style="list-style-type: none"> • Connection type head A: Flying leads • Connection type head B: Flying leads • Signal type: SSI, Incremental • Items supplied: By the meter • Cable: 11-wire, PUR • Description: SSI, Incremental, shielded | LTG-2411-MW | 6027530 |
|  | <ul style="list-style-type: none"> • Connection type head A: Flying leads • Connection type head B: Flying leads • Signal type: SSI, Incremental • Items supplied: By the meter • Cable: 12-wire, PUR, halogen-free • Description: SSI, Incremental, shielded | LTG-2512-MW | 6027531 |
|  | <ul style="list-style-type: none"> • Connection type head A: Flying leads • Connection type head B: Flying leads • Signal type: SSI, TTL, HTL, Incremental • Items supplied: By the meter • Cable: 12-wire, UV and saltwater-resistant, PUR, halogen-free • Description: SSI, TTL, HTL, Incremental, shielded, Head A: cable Head B: cable Cable: suitable for drag chain, PUR, halogen-free, shielded, UV and saltwater resistant, 4 x 2 x 0.25 mm² + 2 x 0.5 mm² + 2 x 0.14 mm², Ø 7.8 mm | LTG-2612-MW | 6028516 |
|  | <ul style="list-style-type: none"> • Product family: Assembly accessories • Description: Bearing block for servo and face mount flange encoder. The heavy-duty bearing block is used to absorb very large radial and axial shaft loads. Particularly when using belt pulleys, chain sprockets, friction wheels. Operating speed max. 4,000 rpm⁻¹, axial shaft load 150 N, radial shaft load 250 N, bearing service life 3.6 x 10⁹ revolutions | BEF-FA-LB1210 | 2044591 |
|  | <ul style="list-style-type: none"> • Product segment: Shaft adaptation • Product family: Shaft couplings • Description: Bellows coupling, shaft diameter 6 mm / 10 mm, maximum shaft offset: radial ± 0.25 mm, axial ± 0.4 mm, angular +/- 4°; max. speed 10,000 rpm, -30 °C to +120 °C, max. torque 120 Ncm; material: stainless steel bellows, aluminum hub | KUP-0610-B | 5312982 |
|  | <ul style="list-style-type: none"> • Product segment: Shaft adaptation • Product family: Shaft couplings • Description: Spring washer coupling, shaft diameter 6 mm / 10 mm, Maximum shaft offset: radial +/- 0.3 mm, axial +/- 0.4 mm, angular +/- 2.5°; max. speed 12,000 rpm, -10° to +80 °C, max. torque 60 Ncm; material: aluminum flange, glass fiber-reinforced polyamide membrane and hardened steel coupling pin | KUP-0610-F | 5312985 |
| | BEF-OR-053-040 | BEF-OR-053-040 | 2064061 |
| | BEF-OR-083-050 | BEF-OR-083-050 | 2064076 |
| | BEF-MK-LB | BEF-MK-LB | 5320872 |
| | BEF-OR-145-050 | BEF-OR-145-050 | 2064074 |
|  | <ul style="list-style-type: none"> • Product segment: Shaft adaptation • Product family: Shaft couplings • Description: Double loop coupling, shaft diameter 6 mm / 10 mm, max. shaft offset: radially +/- 2,5 mm, axially +/--3 mm, angle +/- 10 degrees;max. speed 3.000 rpm, - 30 to +80 degrees Celsius, torsional spring stiffness of 25 Nm/rad | KUP-0610-D | 5326697 |

| | Brief description | Type | Part no. |
|---|--|-------------------|----------|
|  | <ul style="list-style-type: none"> • Product segment: Shaft adaptation • Product family: Shaft couplings • Description: Bar coupling, shaft diameter 6 mm / 10 mm, max. shaft offset: radial $\pm 0,3$ mm, axial $\pm 0,3$ mm, angular $\pm 3^\circ$; max. speed 10.000 rpm, -10° to $+80^\circ$ °C, max. torque: 80 Ncm, material: fiber-glass reinforced polyamide, aluminum hub | KUP-0610-S | 2056407 |
|  | <ul style="list-style-type: none"> • Product segment: Shaft adaptation • Product family: Shaft couplings • Description: Claw coupling, shaft diameter 6 mm / 10 mm, damping element 80 shore blue, maximum shaft offset: radial $\pm 0,22$ mm, axial ± 1 mm angular $\pm 1,3^\circ$, max. speed 19,000 rpm, angle of twist max. 10°, -30° °C to $+80^\circ$ °C, max. torque 800 Ncm, tightening torque of screws: ISO 4029 150 Ncm, material: aluminum flange, damping element: polyurethane | KUP-0610-J | 2127056 |
|  | <ul style="list-style-type: none"> • Product family: Brackets • Description: Mounting bracket for encoder with spigot 36 mm for face mount flange • Items supplied: Mounting kit included | BEF-WF-36 | 2029164 |
|  | <ul style="list-style-type: none"> • Product family: Flanges and nozzles • Description: Flange adapter, adaptation of face mount flange with 36 mm centering hub to 58 mm square mounting plate with shock absorbers, aluminum • Material: Aluminum • Details: Aluminum | BEF-FA-036-060RSA | 2029163 |
|  | <ul style="list-style-type: none"> • Product family: Flanges and nozzles • Description: Flange adapter, adaptation of face mount flange with 36 mm centering hub to 60 mm square mounting plate, aluminum, including 3 flat head screws M4 x 8 • Material: Aluminum • Details: Aluminum • Items supplied: Including 3 countersunk screws M4 x 8 | BEF-FA-036-060REC | 2029162 |
|  | <ul style="list-style-type: none"> • Product family: Flanges and nozzles • Description: Flange adapter, adaptation of face mount flange with 36 mm centering hub to 100 mm servo flange with 60 mm centering hub, aluminum • Material: Aluminum • Details: Aluminum | BEF-FA-036-100 | 2029161 |
|  | <ul style="list-style-type: none"> • Product family: Flanges and nozzles • Description: Flange adapter, adaptation of face mount flange with 36 mm centering hub to 50 mm servo flange, aluminum, including 3 flat head screws M4 x 10 • Material: Aluminum • Details: Aluminum • Items supplied: Including 3 countersunk screws M3 x 10 | BEF-FA-036-050 | 2029160 |
|  | <ul style="list-style-type: none"> • Product family: Flanges and nozzles • Description: Flange adapter, adaptation of face mount flange with 36 mm centering hub to 63 mm square mounting plate, aluminum, including 3 flat head screws M4 x 10 • Material: Aluminum • Details: Aluminum • Items supplied: Including 3 countersunk screws M3 x 10 | BEF-FA-036-063REC | 2034225 |
|  | <ul style="list-style-type: none"> • Product segment: Measuring wheels and measuring wheel mechanics • Product family: Measuring wheels • Description: Aluminium measuring wheel with O-ring (NBR70) for 10 mm solid shaft, circumference 300 mm | BEF-MR010030R | 2049278 |
|  | <ul style="list-style-type: none"> • Product segment: Measuring wheels and measuring wheel mechanics • Product family: Measuring wheels • Description: Aluminium measuring wheel with O-ring (NBR70) for 10 mm solid shaft, circumference 200 mm | BEF-MR010020R | 2055224 |
|  | <ul style="list-style-type: none"> • Product segment: Measuring wheels and measuring wheel mechanics • Product family: Measuring wheels • Description: Measuring wheel with O-ring (NBR70) for 10 mm solid shaft, circumference 500 mm | BEF-MR010050R | 2055227 |

| | Brief description | Type | Part no. |
|---|---|--------------------|----------|
|  | <ul style="list-style-type: none"> • Product segment: Shaft adaptation • Product family: Shaft couplings • Description: Bar coupling, shaft diameter 10 mm / 10 mm; maximum shaft offset: radial ±0.3 mm, axial ± 0.2 mm, angular ± 3°; speed 10,000 rpm, -10° to +80° Celsius, max. torque 80 Ncm; material: glass fiber-reinforced polyamide, aluminum hub | KUP-1010-S | 2056408 |
|  | <ul style="list-style-type: none"> • Product family: Assembly accessories • Description: Flange adapter (adapts size 60 face mount flange encoder to bearing block with part. no. 2044591) | BEF-FA-036-050-019 | 2063378 |
|  | <ul style="list-style-type: none"> • Product segment: Measuring wheels and measuring wheel mechanics • Product family: Measuring wheel mechanics • Description: SICK modular measuring wheel system for face mount flange encoder with S4 mechanical design (10 mm x 19 mm solid shaft), e.g., DFS60-S4: with O-ring measuring wheel, circumference 200 mm • Suitable for: Face mount flange encoder DFS60, DBS60, AFM60, AFS60, mechanical design S4 (solid shaft 10 mm x 19 mm) | BEF-MRS-10-U | 2085714 |
|  | <ul style="list-style-type: none"> • Product segment: Measuring wheels and measuring wheel mechanics • Product family: Measuring wheels • Description: Aluminum measuring wheel with cross-knurled surface for 10 mm solid shaft, circumference 500 mm | BEF-MR10500AK | 4084733 |
|  | <ul style="list-style-type: none"> • Product segment: Measuring wheels and measuring wheel mechanics • Product family: Measuring wheels • Description: Aluminum measuring wheel with smooth polyurethane surface for 10 mm solid shaft, circumference 500 mm | BEF-MR10500AP | 4084734 |
|  | <ul style="list-style-type: none"> • Product segment: Measuring wheels and measuring wheel mechanics • Product family: Measuring wheels • Description: Aluminum measuring wheel with ridged polyurethane surface for 10 mm solid shaft, circumference 200 mm | BEF-MR10200APG | 4084740 |
| | BEF-MR10200APN | BEF-MR10200APN | 4084739 |
|  | <ul style="list-style-type: none"> • Product segment: Measuring wheels and measuring wheel mechanics • Product family: Measuring wheels • Description: Aluminum measuring wheel with smooth polyurethane surface for 10 mm solid shaft, circumference 200 mm | BEF-MR10200AP | 4084738 |
|  | <ul style="list-style-type: none"> • Product segment: Measuring wheels and measuring wheel mechanics • Product family: Measuring wheels • Description: Aluminum measuring wheel with cross-knurled surface for 10 mm solid shaft, circumference 200 mm | BEF-MR10200AK | 4084737 |
|  | <ul style="list-style-type: none"> • Product segment: Measuring wheels and measuring wheel mechanics • Product family: Measuring wheels • Description: Aluminum measuring wheel with ridged polyurethane surface for 10 mm solid shaft, circumference 500 mm | BEF-MR10500APG | 4084736 |
|  | <ul style="list-style-type: none"> • Product segment: Measuring wheels and measuring wheel mechanics • Product family: Measuring wheels • Description: Aluminum measuring wheel with studded polyurethane surface for 10 mm solid shaft, circumference 500 mm | BEF-MR10500APN | 4084735 |
|  | <ul style="list-style-type: none"> • Product family: Brackets • Description: Mounting angle spring-loaded, for flange with centering collar 36 mm, working temperature range -40° ... +120°C • Details: Aluminum | BEF-WF36F | 4084775 |
|  | <ul style="list-style-type: none"> • Product segment: Shaft adaptation • Product family: Shaft couplings • Description: Bellows coupling, shaft diameter 10 mm/10 mm; maximum shaft offset: radial +/- 0.25 mm, axial +/- 0.4 mm, angular +/- 4°; max. revolutions 10,000 rpm, -30° to +120 °C, max. torque 120 Ncm; material: stainless steel bel-lows, aluminum clamping hubs | KUP-1010-B | 5312983 |

| | Brief description | Type | Part no. |
|---|--|--------------|----------|
|  | <ul style="list-style-type: none"> • Product segment: Shaft adaptation • Product family: Shaft couplings • Description: 10 mm / 12 mm; maximum shaft offset: radial +/- 0.25 mm, axial +/- 0.4 mm, angular +/- 4°; max. revolutions 10,000 rpm, -30° to +120 °C, max. torque 120 Ncm; material: stainless steel bellows, aluminum clamping hubs | KUP-1012-B | 5312984 |
|  | <ul style="list-style-type: none"> • Product segment: Shaft adaptation • Product family: Shaft couplings • Description: Spring washer coupling, shaft diameter 10 mm / 10 mm, maximum shaft offset, radial ± 0.3 mm, axial ± 0.4 mm, angle ± 2.5°, torsion spring stiffness 30 Nm/rad; material: aluminum flange, glass-fiber reinforced polyamide membrane and hardened steel coupling pin | KUP-1010-F | 5312986 |
|  | <ul style="list-style-type: none"> • Product segment: Shaft adaptation • Product family: Shaft couplings • Description: Bar coupling, shaft diameter 8 mm / 10 mm, max. shaft offset: radial ± 0,3 mm, axial ± 0,3 mm, angular ± 3°; max. speed 10.000 rpm, -10° to +80 °C, max. torque: 80 Ncm, material: fiber-glass reinforced polyamide, aluminum hub | KUP-0810-S | 5314178 |
|  | <ul style="list-style-type: none"> • Product segment: Shaft adaptation • Product family: Shaft couplings • Description: Spring coupling, shaft diameter 10 mm / 10 mm, maximum shaft offset: radial ± 1.5 mm, axial ± 1.0 mm, angular ± 5°, max. speed 3,000 rpm, -30° to +120 °Celsius, nominal torque 150 Ncm, rotational angle at half nominal torque, direction of rotation right viewed on driving shaft 40°, left viewed on driving shaft 60°, material: spring steel 1.0600 nickel plated, zinc die cast hubs | KUP-1010-W | 5319914 |
|  | <ul style="list-style-type: none"> • Product segment: Shaft adaptation • Product family: Shaft couplings • Description: Double loop coupling, shaft diameter 10 mm / 10 mm, Maximum shaft offset: radial +/- 2.5 mm, axial +/- 3 mm, angular +/- 10°; max. speed 3,000 rpm, -30° to +80 °C, max. torque 1.5 Nm; material: polyurethane, galvanized steel flange | KUP-1010-D | 5326703 |
|  | <ul style="list-style-type: none"> • Product segment: Shaft adaptation • Product family: Shaft couplings • Description: Double loop coupling, shaft diameter 8 mm / 10 mm, max. shaft offset: radially +/- 0,25 mm, axially +/-0,4 mm, angle +/- 4 degrees;max. speed 10.000 rpm, -30 to +120 degrees Celsius, torsional spring stiffness of 150 Nm/rad | KUP-0810-D | 5326704 |
|  | <ul style="list-style-type: none"> • Product segment: Shaft adaptation • Product family: Shaft couplings • Description: Claw coupling, shaft diameter 8 mm / 10 mm, damping element 80 shore blue, maximum shaft offset: radial ± 0.22 mm, axial ± 1 mm angular ± 1.3°, max. speed 19,000 rpm, angle of twist max. 10°, -30 °C to +80 °C, max. torque 800 Ncm, tightening torque of screws: ISO 4029 150 Ncm, material: aluminum flange, damping element: polyurethane | KUP-0810-J | 2128267 |
|  | <ul style="list-style-type: none"> • Product segment: Shaft adaptation • Product family: Shaft couplings • Description: Claw coupling, shaft diameter 10 mm / 10 mm, damping element 80 shore blue, maximum shaft offset: radial ± 0.22 mm, axial ± 1 mm angular ± 1.3°, max. speed 19,000 rpm, angle of twist max. 10°, -30 °C to +80 °C, max. torque 800 Ncm, tightening torque of screws: ISO 4029 150 Ncm, material: aluminum flange, damping element: polyurethane | KUP-1010-J | 2127054 |
|  | <ul style="list-style-type: none"> • Connection type head A: Male connector, M23, 12-pin, straight, A-coded • Signal type: HIPERFACE®, SSI, Incremental • Description: HIPERFACE®, SSI, Incremental, shielded, Head A: male connector, M23, 12-pin, straight, for cable diameter 5.5 mm ... 10.5 mm Head B: - Operating temperature: -40 °C ... +125 °C • Connection systems: Solder connection | STE-2312-G01 | 2077273 |
|  | <ul style="list-style-type: none"> • Connection type head A: Male connector, M23, 12-pin, straight, A-coded • Signal type: HIPERFACE®, SSI, Incremental • Description: HIPERFACE®, SSI, Incremental, shielded, M23 female connector with central fixing (for cabinet bushing) • Connection systems: Solder connection | STE-2312-GX | 6028548 |

| | Brief description | Type | Part no. |
|---|---|---------------|----------|
|  | <ul style="list-style-type: none"> • Connection type head A: Male connector, M12, 8-pin, straight, A-coded • Signal type: Incremental • Cable: CAT5, CAT5e • Description: Incremental, shielded, Head A: male connector, M12, 8-pin, straight, A coded, shielded, for cable diameter 4 mm ... 8 mm Head B: - Operating temperature: -40 °C ... +85 °C • Connection systems: IDC quick connection • Permitted cross-section: 0.14 mm² ... 0.34 mm² | STE-1208-GA01 | 6044892 |

SICK AT A GLANCE

SICK is one of the leading manufacturers of intelligent sensors and sensor solutions for industrial applications. A unique range of products and services creates the perfect basis for controlling processes securely and efficiently, protecting individuals from accidents and preventing damage to the environment.

We have extensive experience in a wide range of industries and understand their processes and requirements. With intelligent sensors, we can deliver exactly what our customers need. In application centers in Europe, Asia and North America, system solutions are tested and optimized in accordance with customer specifications. All this makes us a reliable supplier and development partner.

Comprehensive services complete our offering: SICK LifeTime Services provide support throughout the machine life cycle and ensure safety and productivity.

For us, that is “Sensor Intelligence.”

WORLDWIDE PRESENCE:

Contacts and other locations –www.sick.com