



TBT-1PAZZ2506GZ

TBT

TEMPERATURE SENSORS

SICK
Sensor Intelligence.



Illustration may differ



Ordering information

Type	Part no.
TBT-1PAZZ2506GZ	6043011

Other models and accessories → www.sick.com/TBT

Detailed technical data

Features

Measuring range	-50 °C ... +150 °C
Sensor element	Pt100
Output signal	Pt100, 4-wire

Mechanics/electronics

Process connection	Without process connection
Insertion length/diameter of probe	250 mm / 6 mm
Wetted parts	Stainless steel 1.4571
Housing material	Aluminum
Connection type	Cable gland M16 x 1.5 ¹⁾
Enclosure rating	IP65 ²⁾
Measuring current	0.3 mA ... 1 mA
Electrical safety	Protection class: III, dielectric strength: 100 V
Protection class III	✓
CE-conformity	2004/108/EC, EN 61326-2-3
RoHS certificate	✓
Weight	Ca. 155 g (depending on configuration)
Initialization time	< 1 ms

¹⁾ The enclosure rating classes specified only apply while the thermometer is connected with female connectors that provide the corresponding enclosure rating.

²⁾ IP enclosure rating as per IEC 60529.

Performance

Accuracy of sensor element	Class A according to IEC 60751
Transmitter accuracy	≤ ± 0.1 % of span
Transmitter linearity	≤ 0.1 % of span
Response time	Response time t_{50} : ≤ 5.8 s ¹⁾ Response time t_{90} : ≤ 15.5 s ¹⁾

¹⁾ Depending on sensor configuration, according to IEC 60751.

Ambient data

Ambient temperature	-40 °C ... +125 °C
Storage and transport temperature	-40 °C ... +60 °C
Shock resistance according to IEC 60751	500 g
Vibration resistance according to IEC 60751	3 g

Classifications

ECLASS 5.0	27200208
ECLASS 5.1.4	27200208
ECLASS 6.0	27200208
ECLASS 6.2	27200208
ECLASS 7.0	27200208
ECLASS 8.0	27200208
ECLASS 8.1	27200208
ECLASS 9.0	27200208
ECLASS 10.0	27200208
ECLASS 11.0	27200208
ECLASS 12.0	27200208
ETIM 5.0	EC002994
ETIM 6.0	EC002994
ETIM 7.0	EC002994
ETIM 8.0	EC002994
UNSPSC 16.0901	41112211

Dimensional drawing (Dimensions in mm (inch))

Dimensional drawing: cylindrical threads

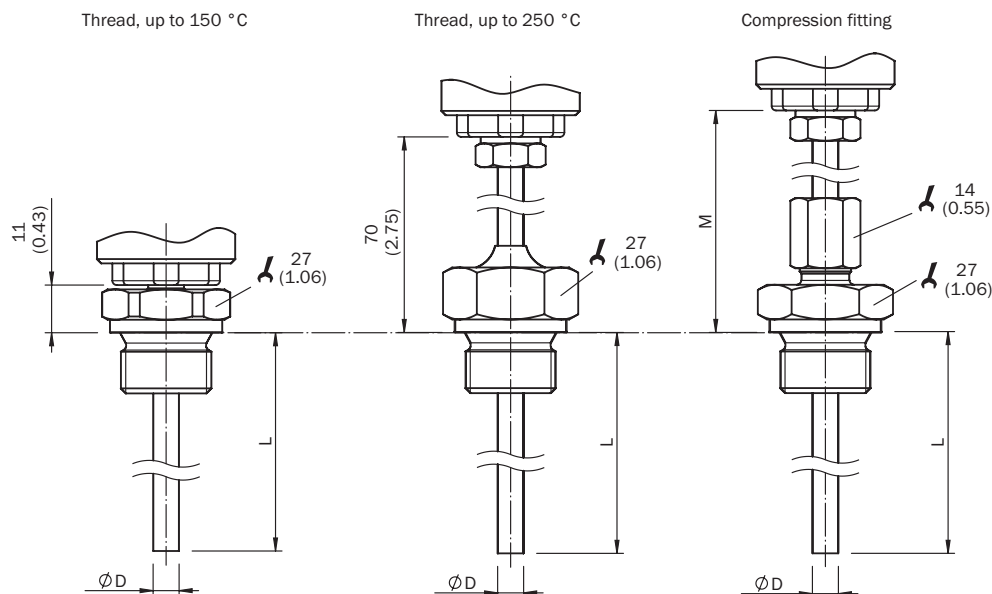

Dimensional drawing: conical threads

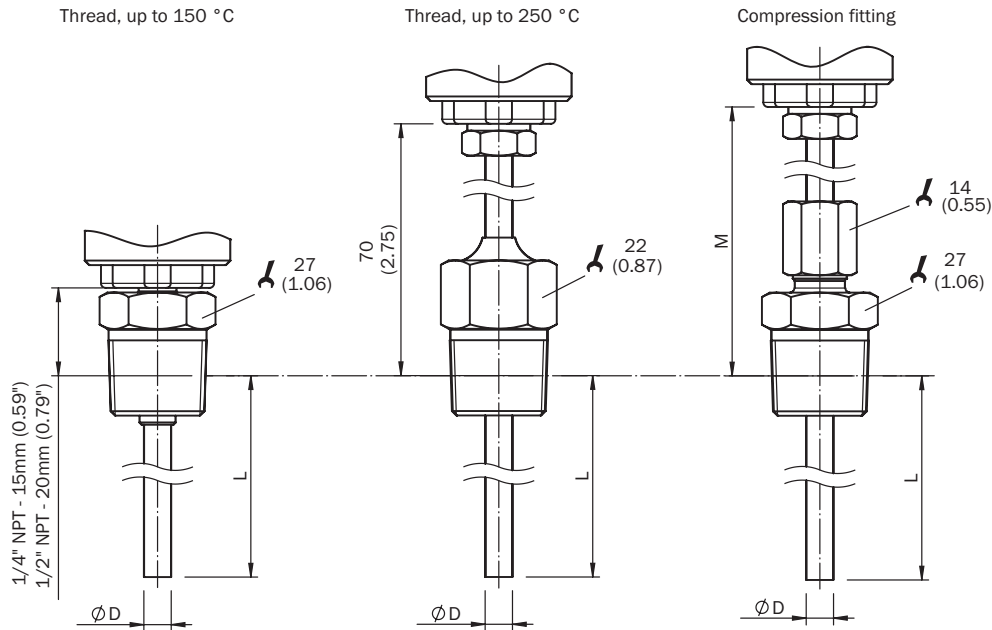

Dimensional drawing: housing, without process connection

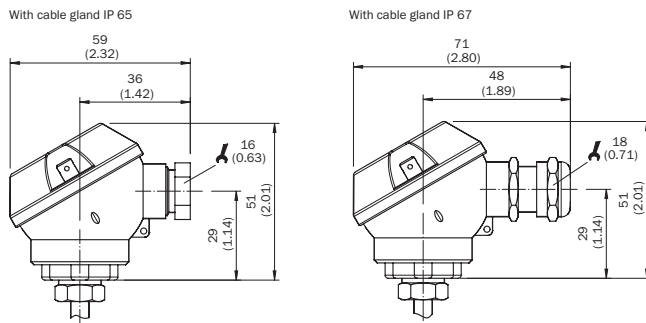

Connection type

Cable entry M16 x 1.5, cable cross-section up to 0.75 mm², output signal Pt100

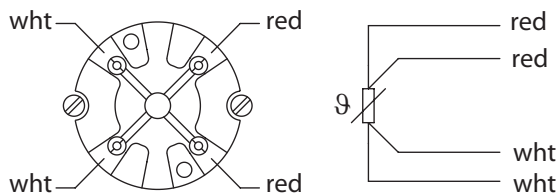

SICK AT A GLANCE

SICK is one of the leading manufacturers of intelligent sensors and sensor solutions for industrial applications. A unique range of products and services creates the perfect basis for controlling processes securely and efficiently, protecting individuals from accidents and preventing damage to the environment.

We have extensive experience in a wide range of industries and understand their processes and requirements. With intelligent sensors, we can deliver exactly what our customers need. In application centers in Europe, Asia and North America, system solutions are tested and optimized in accordance with customer specifications. All this makes us a reliable supplier and development partner.

Comprehensive services complete our offering: SICK LifeTime Services provide support throughout the machine life cycle and ensure safety and productivity.

For us, that is “Sensor Intelligence.”

WORLDWIDE PRESENCE:

Contacts and other locations –www.sick.com