



IMP12-1B5PSVC0B

IMP

ENDÜKTİF YAKLAŞIM SENSÖRLERİ

SICK
Sensor Intelligence.



Resimler farklı olabilir



Sipariş bilgileri

Tip	Stok no.
IMP12-1B5PSVC0B	6050113

Diğer cihaz modelleri ve aksesuar → www.sick.com/IMP

Ayrıntılı teknik bilgiler

Özellikler

Gövde yapısı	Metrik
Vida dişi büyüklüğü	M12 x 1
Çap	Ø 12 mm
Basınca karşı dayanıklılık	≤ 500 bar
Algılama mesafesi S_n	1,5 mm
Emniyete alınmış algılama mesafesi S_a	1,2 mm
Metale montaj	Düz kafa
Anahtarlama frekansı	600 Hz
Bağlantı tipi	Soket M12, 4-pin
Anahtarlama çıkışı	PNP
Anahtarlama çıkışı ayrıntısı	PNP
Çıkış fonksiyonu	Normalde açık
Elektriksel kablolama	DC 3 telli
Koruma sınıfı	IP68 ¹⁾
Özel özellikler	Yüksek basınca dayanıklı
Özel uygulamalar	Hidrolik uygulaması

¹⁾ Algılama yüzeyi.

Mekanik/Elektrik

Besleme Gerilimi	10 V DC ... 30 V DC
Sinyal taşıma	≤ 20 % ¹⁾
Gerilim düşmesi	≤ 2 V ²⁾
Zaman gecikmesi	≤ 50 ms

¹⁾ Başlangıç U_V değeri.

²⁾ $I_a = 200$ mA'de.

³⁾ Tip. %8.

⁴⁾ $U_b = 20 \dots 30$ VDC.

⁵⁾ $T_a = 23 \text{ °C} \pm 5 \text{ °C}$.

⁶⁾ Ön taraf.

Histerezis	1 % ... 15 % ³⁾
Tekrarlanabilirlik	≤ 7 % ^{4) 5)}
Sıcaklık sapması (başlangıç S, değeri)	≤ 15 %
EMVC	EN 60947-5-2 uyarınca
Sürekli akım I_a	≤ 200 mA
Vakuma karşı dayanıklılık	10 ⁻⁸ Torr ⁶⁾
Sızdırmaz conta büyüklüğü	5,3 mm x 2,4 mm
Destek halkası büyüklüğü	10 mm x 5,9 mm x 1 mm
Kısa devre koruması	✓
Darbe ve titreşim dayanımı	30 g, 11 ms / 10 ... 55 Hz, 1 mm
Çalışma ortamı sıcaklığı	-25 °C ... +80 °C
Gövde malzemesi	Paslanmaz çelik V2A, DIN 1.4305 / AISI 303
Malzeme, algılama yüzeyi	Seramik, ZrO ₂
Sızdırmaz conta malzemesi	FPM
Gövde uzunluğu	56 mm
Faydalı vida dişi uzunluğu	28 mm
Maks. sıkma torku	≤ 40 Nm

1) Başlangıç U_y değeri.

2) I_a = 200 mA'de.

3) Tip. %8.

4) U_b = 20 ... 30 VDC.

5) T_a = 23 °C ± 5 °C.

6) Ön taraf.

Emniyet tekniği parametreleri

MTTF_D	171 yıl
DC_{avg}	%0
T_M (kullanım ömrü)	20 yıl

Düşürüm katsayıları

Bilgi	Değerler, değişebilen kılavuz değerlerdir
Çelik St37 (Fe)	1
Paslanmaz çelik (V2A)	Yakl. 0,75
Alüminyum (Al)	Yakl. 0,2
Bakır (Cu)	Yakl. 0,12
Pirinç (sarı) (Ms)	Yakl. 0,34

Montaj uyarısı

Not	İlgili grafik için bakınız "montaj uyarısı"
B	8 mm
C	12 mm
D	6 mm
F	12 mm

Sınıflandırmalar

ECLASS 5.0	27270101
ECLASS 5.1.4	27270101
ECLASS 6.0	27270101
ECLASS 6.2	27270101
ECLASS 7.0	27270101
ECLASS 8.0	27270101
ECLASS 8.1	27270101
ECLASS 9.0	27270101
ECLASS 10.0	27270101
ECLASS 11.0	27270101
ECLASS 12.0	27274001
ETIM 5.0	EC002714
ETIM 6.0	EC002714
ETIM 7.0	EC002714
ETIM 8.0	EC002714
UNSPSC 16.0901	39122230

Montaj uyarısı

Düz kafalı montaj

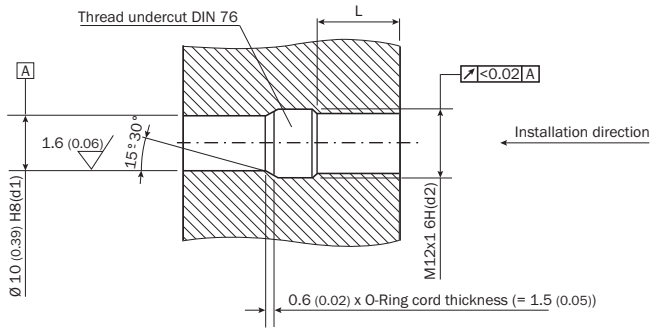
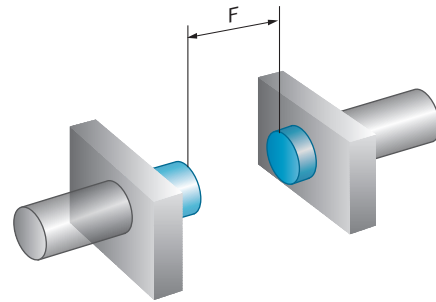
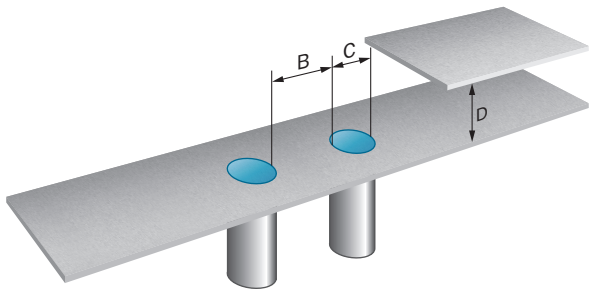

L: recommended installation depth: $L \geq 0.8 (0.03) \times d2$

Bağlantı şeması

Cd-007

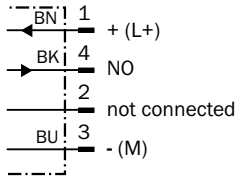

Teknik çizim (Ölçüler mm cinsindedir)

IMP12-xxxxxxxB, 56 mm

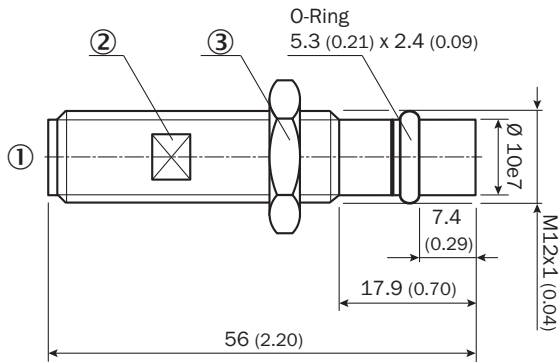





























- ① Soket M12, 4-pin
- ② Anahtar numarası 10
- ③ Anahtar numarası 17

Önerilen aksesuar

Diğer cihaz modelleri ve aksesuar → www.sick.com/IMP

	Kısa açıklama	Tip	Stok no.
Diğer			
	<ul style="list-style-type: none"> • Ürün ailesi: Montaj aksesuarları • Boyutlar (G x Y x U): 5,3 mm x 2,4 mm • Uygun olduğu yerler: IMP12 	IMP12 O halkası	5327494
	<ul style="list-style-type: none"> • Ürün ailesi: Montaj aksesuarları • Boyutlar (G x Y x U): 10 mm x 5,9 mm x 1 mm • Uygun olduğu yerler: IMP12 	IMP12 destek halkası	5327496
		YF2A14-020UB3XLEAX	2095607
		YF2A14-050UB3XLEAX	2095608
		YG2A14-020UB3XLEAX	2095766

	Kısa açıklama	Tip	Stok no.
		YG2A14-050UB3XLEAX	2095767
		YF2A14-020VB3XLEAX	2096234
		YF2A14-050VB3XLEAX	2096235
		YG2A14-020VB3XLEAX	2095895
		YG2A14-050VB3XLEAX	2095897
		YF2A14-C60UB3XLEAX	2145654
		YF2A14-010UB3XLEAX	2145655
		YF2A14-030UB3XLEAX	2145656
		YG2A14-C60UB3XLEAX	2145657
		YG2A14-010UB3XLEAX	2145658
		YG2A14-C60VB3XLEAX	2145709
		YG2A14-010VB3XLEAX	2145710
		YF2A14-C60VB3XLEAX	2145707
		YF2A14-010VB3XLEAX	2145708

BİR BAKIŞTA SICK

SICK, endüstriyel uygulamalarda akıllı sensör ve sensör çözümleri konusunda lider üreticilerdendir. Eşsiz bir ürün ve hizmet yelpazesi; süreçlerin güvenli ve etkili şekilde kontrolünü, kişilerin kazalardan korunmasını ve çevreye verilen zararların önlenmesini sağlayan mükemmel temeli oluşturur.

Çok çeşitli branşlarda kapsamlı bilgi birikimine sahibiz ve süreçleriniz ile gerekliliklerinizi iyi biliyoruz. İşte bu sayede akıllı sensörlerle tam da müşterilerimizin ihtiyacı olanı teslim edebiliyoruz. Sistem çözümleri Avrupa, Asya ve Kuzey Amerika'da bulunan uygulama merkezlerinde müşteriye özel olarak test ve optimize edilir. Bütün bunlar bizi güvenilir bir tedarikçi ve ARGE ortağı haline getiriyor.

Kapsamlı hizmetlerimiz teklifimizi tamamlar: SICK Ömür Boyu servis hizmeti makinenin kullanım ömrü boyunca güvenlik ve verimlilik ile ilgili destek sağlar.

Bu bizim için "Sensör Zekası"dır.

DÜNYA GENELİNDE HEMEN YAKININIZDA:

Bilgi almak ve diğer merkezler için → www.sick.com