



# DUS60E-RBKC0AAA

DUS60

INCREMENTAL ENCODERS

**SICK**  
Sensor Intelligence.

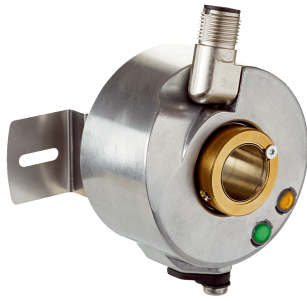

Illustration may differ



### Ordering information

| Type            | Part no. |
|-----------------|----------|
| DUS60E-RBKC0AAA | 1087246  |

Other models and accessories → [www.sick.com/DUS60](http://www.sick.com/DUS60)

### Detailed technical data

#### Safety-related parameters

|  |  |
|--|--|
| <b>MTTF<sub>D</sub> (mean time to dangerous failure)</b> | 275 years (EN ISO 13849-1) <sup>1)</sup> |
|--|--|

<sup>1)</sup> This product is a standard product and does not constitute a safety component as defined in the Machinery Directive. Calculation based on nominal load of components, average ambient temperature 40 °C, frequency of use 8760 h/a. All electronic failures are considered hazardous. For more information, see document no. 8015532.

#### Performance

|                                 |                                     |
|---------------------------------|-------------------------------------|
| <b>Measuring step</b>           | 90°, electric/pulses per revolution |
| <b>Measuring step deviation</b> | ± 18° / pulses per revolution       |
| <b>Error limits</b>             | Measuring step deviation x 3        |
| <b>Duty cycle</b>               | ≤ 0.5 ± 5 %                         |

#### Interfaces

|                                       |  |
|---------------------------------------|--|
| <b>Communication interface</b>        | Incremental  |
| <b>Communication Interface detail</b> | TTL / HTL <sup>1)</sup>                                  |
| <b>Parameterising data</b>            | DIP switch, selectable output                            |
| <b>Output function</b>                | A and B output   |
| <b>Initialization time</b>            | < 5 ms <sup>2)</sup>                                     |
| <b>Output frequency</b>               | + 60 kHz   |
| <b>Load current</b>                   | ≤ 30 mA, per channel                                     |
| <b>Operating current</b>              | ≤ 120 mA (without load)                                  |
| <b>Power consumption</b>              | ≤ 1.25 W (without load)                                  |
| <b>DIP switch parameters</b>          |  |
| Pulses per revolution                 | ✓  |
| Output voltage                        | ✓  |
| Direction of rotation                 | ✓  |
| Configuration switches                | 2400 PPR values, direction selection, TTL/HTL selectable |

<sup>1)</sup> The output is not selectable for DIP switch configurations E, F, and G. The output voltage value is dependent on the supply voltage.

<sup>2)</sup> Valid positional data can be read once this time has elapsed.

## Electronics

|  |   |
|--|---|
| <b>Connection type</b>                         | Male connector, M12, 8-pin, universal <sup>1)</sup> |
| <b>Supply voltage</b>                          | 4.75 ... 30 V                                       |
| <b>Reference signal, number</b>                | 1   |
| <b>Reference signal, position</b>              | 180°, electric, gated with A                        |
| <b>Reverse polarity protection</b>             | ✓   |
| <b>Short-circuit protection of the outputs</b> | ✓   |

<sup>1)</sup> The universal connection is rotatable so that it is possible to position the connector in the radial or axial direction.

## Mechanics

|                                       |  |
|---------------------------------------|--|
| <b>Mechanical design</b>              | Through hollow shaft, rear clamping                        |
| <b>Shaft diameter</b>                 | 8 mm   |
| <b>Flange type / stator coupling</b>  | 2-point stator coupling, slot, hole diameter 63 mm – 83 mm |
| <b>Weight</b>                         | 0.25 kg <sup>1)</sup>                                      |
| <b>Shaft material</b>                 | Stainless steel  |
| <b>Flange material</b>                | Aluminum   |
| <b>Housing material</b>               | Aluminum   |
| <b>Material, cable</b>                | PVC  |
| <b>Start up torque</b>                | 0.5 Ncm (+20 °C)   |
| <b>Operating torque</b>               | 0.4 Ncm (+20 °C)   |
| <b>Permissible movement static</b>    | ± 0.3 mm (radial)<br>± 0.5 mm (axial)                      |
| <b>Permissible movement dynamic</b>   | ± 0.1 mm (radial)<br>± 0.2 mm (axial)                      |
| <b>Operating speed</b>                | 1,500 min <sup>-1</sup>                                    |
| <b>Moment of inertia of the rotor</b> | 50 gcm <sup>2</sup>  |
| <b>Bearing lifetime</b>               | 3.6 x 10 <sup>9</sup> revolutions                          |
| <b>Angular acceleration</b>           | ≤ 500,000 rad/s <sup>2</sup>                               |

<sup>1)</sup> Based on encoder with male connector.

## Ambient data

|                                      |  |
|--------------------------------------|--|
| <b>EMC</b>                           | According to EN 61000-6-2 and EN 61000-6-3 |
| <b>Enclosure rating</b>              | IP65 <sup>1)</sup>                         |
| <b>Permissible relative humidity</b> | 90 % (Condensation not permitted)          |
| <b>Operating temperature range</b>   | -30 °C ... +90 °C                          |
| <b>Storage temperature range</b>     | -40 °C ... +75 °C                          |
| <b>Resistance to shocks</b>          | 100 g (EN 60068-2-27)                      |
| <b>Resistance to vibration</b>       | 30 g, 10 Hz ... 2,000 Hz (EN 60068-2-6)    |

<sup>1)</sup> When the mating connector is installed and the DIP switch door is sealed with the encoder housing.

## Classifications

|                     |          |
|---------------------|----------|
| <b>ECLASS 5.0</b>   | 27270501 |
| <b>ECLASS 5.1.4</b> | 27270501 |

|                       |          |
|-----------------------|----------|
| <b>ECLASS 6.0</b>     | 27270590 |
| <b>ECLASS 6.2</b>     | 27270590 |
| <b>ECLASS 7.0</b>     | 27270501 |
| <b>ECLASS 8.0</b>     | 27270501 |
| <b>ECLASS 8.1</b>     | 27270501 |
| <b>ECLASS 9.0</b>     | 27270501 |
| <b>ECLASS 10.0</b>    | 27270501 |
| <b>ECLASS 11.0</b>    | 27270501 |
| <b>ECLASS 12.0</b>    | 27270501 |
| <b>ETIM 5.0</b>       | EC001486 |
| <b>ETIM 6.0</b>       | EC001486 |
| <b>ETIM 7.0</b>       | EC001486 |
| <b>ETIM 8.0</b>       | EC001486 |
| <b>UNSPSC 16.0901</b> | 41112113 |

### Dimensional drawing (Dimensions in mm (inch))

Through hollow shaft with rear clamping

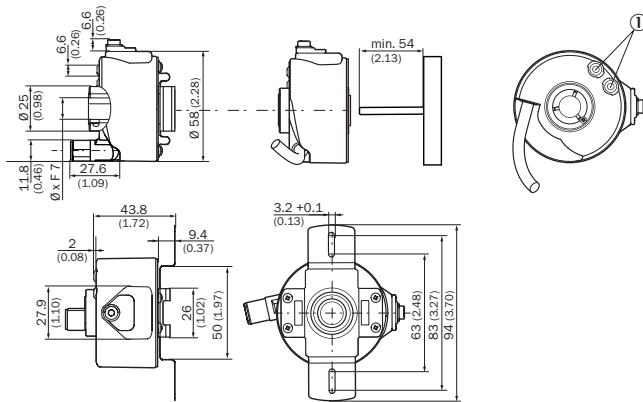

① Status indicators

### PIN assignment

View of M12 male device connector on encoder

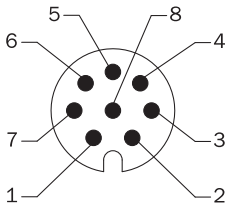

| Wire colors (cable connection) | Male connector M12, 4-pin | Male connector M12, 8-pin | Output function |     |    |    | Explanation |
|--------------------------------|---------------------------|---------------------------|-----------------|-----|----|----|-------------|
|                                |                           |                           | A               | B   | C  | D  |             |
| Brown                          | -                         | 1                         | A-              | CW- | A- | A- | Signal      |

| Wire colors (cable connection) | Male connector M12, 4-pin | Male connector M12, 8-pin | Output function |                |                |   | Explanation            |
|--------------------------------|---------------------------|---------------------------|-----------------|----------------|----------------|---|------------------------|
|                                |                           |                           | A               | B              | C              | D   |                        |
| White                          | 4                         | 2                         | A               | CW             | A              | A   | Signal                 |
| Black                          | -                         | 3                         | B-              | CCW-           | Direction-     | B-  | Signal                 |
| Pink                           | 2                         | 4                         | B               | CCW            | Direction      | Fault (M12, 4-pin)<br>B (M12, 8-pin and cable connection) | Signal                 |
| Yellow                         | -                         | 5                         | Z-              | Fault-         | Fault-         | Fault-  | Signal                 |
| Violet                         | -                         | 6                         | Z               | Fault          | Fault          | Fault   | Signal                 |
| Blue                           | 3                         | 7                         | GND             | GND            | GND            | GND   | Ground connection      |
| Red                            | 1                         | 8                         | U <sub>S</sub>  | U <sub>S</sub> | U <sub>S</sub> | U <sub>S</sub>  | Supply voltage         |
| -                              | -                         | -                         | Case            | Case           | Case           | Case  | Earth fault protection |
| Shielding                      | -                         | -                         | Shielding       | Shielding      | Shielding      | Shielding   | Shielding              |

## Adjustments



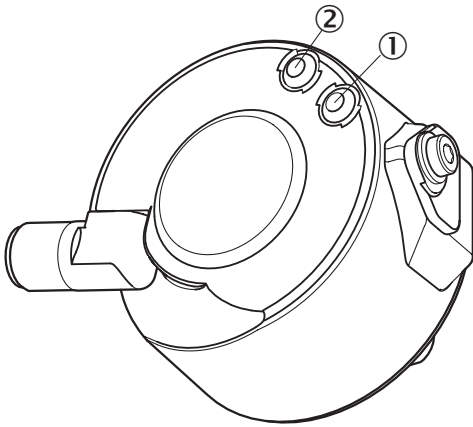





Status indicator LED







- ① Signal
- ② Fault/Power

### Recommended accessories

Other models and accessories → [www.sick.com/DUS60](http://www.sick.com/DUS60)

|   | Brief description   | Type             | Part no. |
|---|---|------------------|----------|
| Others  |   |                  |          |
|    | <ul style="list-style-type: none"> <li>• <b>Connection type head A:</b> Female connector, M12, 8-pin, straight</li> <li>• <b>Connection type head B:</b> Flying leads</li> <li>• <b>Signal type:</b> Incremental, SSI</li> <li>• <b>Cable:</b> 2 m, 8-wire, PUR, halogen-free</li> <li>• <b>Description:</b> Incremental, SSI, shielded, Head A: female connector, M12, 8-pin, straight Head B: cable Cable: suitable for drag chain, PVC, shielded, 4 x 2 x 0.25 mm<sup>2</sup>, Ø 7.0 mm</li> <li>• <b>Connection systems:</b> Flying leads</li> </ul>                                      | DOL-1208-G02MAC1 | 6032866  |
|    | <ul style="list-style-type: none"> <li>• <b>Connection type head A:</b> Female connector, M12, 8-pin, straight</li> <li>• <b>Connection type head B:</b> Flying leads</li> <li>• <b>Signal type:</b> Incremental, SSI</li> <li>• <b>Cable:</b> 5 m, 8-wire, PUR, halogen-free</li> <li>• <b>Description:</b> Incremental, SSI, shielded, Head A: female connector, M12, 8-pin, straight Head B: cable Cable: suitable for drag chain, PVC, shielded, 4 x 2 x 0.25 mm<sup>2</sup>, Ø 7.0 mm</li> <li>• <b>Connection systems:</b> Flying leads</li> </ul>                                      | DOL-1208-G05MAC1 | 6032867  |
|    | <ul style="list-style-type: none"> <li>• <b>Connection type head A:</b> Female connector, M12, 8-pin, straight</li> <li>• <b>Connection type head B:</b> Flying leads</li> <li>• <b>Signal type:</b> Incremental, SSI</li> <li>• <b>Cable:</b> 10 m, 8-wire, PUR, halogen-free</li> <li>• <b>Description:</b> Incremental, SSI, shielded, Head A: female connector, M12, 8-pin, straight Head B: cable Cable: suitable for drag chain, PVC, shielded, 4 x 2 x 0.25 mm<sup>2</sup>, Ø 7.0 mm</li> <li>• <b>Connection systems:</b> Flying leads</li> </ul>                                     | DOL-1208-G10MAC1 | 6032868  |
|   | <ul style="list-style-type: none"> <li>• <b>Connection type head A:</b> Female connector, M12, 8-pin, straight</li> <li>• <b>Connection type head B:</b> Flying leads</li> <li>• <b>Signal type:</b> Incremental, SSI</li> <li>• <b>Cable:</b> 20 m, 8-wire, PUR, halogen-free</li> <li>• <b>Description:</b> Incremental, SSI, shielded, Head A: female connector, M12, 8-pin, straight Head B: cable Cable: suitable for drag chain, PVC, shielded, 4 x 2 x 0.25 mm<sup>2</sup>, Ø 7.0 mm</li> <li>• <b>Connection systems:</b> Flying leads</li> </ul>                                     | DOL-1208-G20MAC1 | 6032869  |
|  | <ul style="list-style-type: none"> <li>• <b>Connection type head A:</b> Female connector, M12, 8-pin, straight, A-coded</li> <li>• <b>Signal type:</b> Incremental, SSI</li> <li>• <b>Cable:</b> CAT5, CAT5e</li> <li>• <b>Description:</b> Incremental, SSI, shielded, Head A: female connector, M12, 8-pin, straight, A encoded, shielded, for cable diameter 4 mm ... 8 mm Head B: - Operating temperature: -40 °C ... +85 °C</li> <li>• <b>Connection systems:</b> IDC quick connection</li> <li>• <b>Permitted cross-section:</b> 0.14 mm<sup>2</sup> ... 0.34 mm<sup>2</sup></li> </ul> | DOS-1208-GA01    | 6045001  |
|  | <ul style="list-style-type: none"> <li>• <b>Connection type head A:</b> Female connector, M12, 8-pin, angled</li> <li>• <b>Connection type head B:</b> Flying leads</li> <li>• <b>Signal type:</b> HIPERFACE<sup>®</sup>, Incremental</li> <li>• <b>Cable:</b> 2 m, 8-wire, PUR, halogen-free</li> <li>• <b>Description:</b> HIPERFACE<sup>®</sup>, Incremental, shielded</li> </ul>  | DOL-1208-W02MAC1 | 6037724  |
|  | <ul style="list-style-type: none"> <li>• <b>Connection type head A:</b> Female connector, M12, 8-pin, angled</li> <li>• <b>Connection type head B:</b> Flying leads</li> <li>• <b>Signal type:</b> HIPERFACE<sup>®</sup>, Incremental</li> <li>• <b>Cable:</b> 5 m, 8-wire, PUR, halogen-free</li> <li>• <b>Description:</b> HIPERFACE<sup>®</sup>, Incremental, shielded</li> </ul>  | DOL-1208-W05MAC1 | 6037725  |
|  | <ul style="list-style-type: none"> <li>• <b>Connection type head A:</b> Female connector, M12, 8-pin, angled</li> <li>• <b>Connection type head B:</b> Flying leads</li> <li>• <b>Signal type:</b> HIPERFACE<sup>®</sup>, Incremental</li> <li>• <b>Cable:</b> 10 m, 8-wire, PUR, halogen-free</li> <li>• <b>Description:</b> HIPERFACE<sup>®</sup>, Incremental, shielded</li> </ul>   | DOL-1208-W10MAC1 | 6037726  |

|   | Brief description   | Type              | Part no. |
|---|---|-------------------|----------|
|    | <ul style="list-style-type: none"> <li>• <b>Connection type head A:</b> Female connector, M12, 8-pin, angled</li> <li>• <b>Connection type head B:</b> Flying leads</li> <li>• <b>Signal type:</b> HIPERFACE®, Incremental</li> <li>• <b>Cable:</b> 20 m, 8-wire, PUR</li> <li>• <b>Description:</b> HIPERFACE®, Incremental, shielded</li> </ul>   | DOL-1208-W20MAC1  | 6037727  |
|    | <ul style="list-style-type: none"> <li>• <b>Connection type head A:</b> Female connector, M12, 8-pin, angled</li> <li>• <b>Connection type head B:</b> Flying leads</li> <li>• <b>Cable:</b> 2 m, 8-wire, PVC</li> <li>• <b>Description:</b> Shielded</li> <li>• <b>Connection systems:</b> Flying leads</li> </ul>   | DOL-1208-W02MA    | 6020992  |
|    | <ul style="list-style-type: none"> <li>• <b>Connection type head A:</b> Female connector, M12, 8-pin, angled</li> <li>• <b>Connection type head B:</b> Flying leads</li> <li>• <b>Signal type:</b> Sensor/actuator cable</li> <li>• <b>Cable:</b> 2 m, 8-wire, PUR, halogen-free</li> <li>• <b>Description:</b> Sensor/actuator cable, shielded</li> <li>• <b>Connection systems:</b> Flying leads</li> </ul> | DOL-1208-W02MAS01 | 6029224  |
|    | <ul style="list-style-type: none"> <li>• <b>Connection type head A:</b> Female connector, M12, 8-pin, angled</li> <li>• <b>Connection type head B:</b> Flying leads</li> <li>• <b>Cable:</b> 2 m, 8-wire, PUR, halogen-free</li> <li>• <b>Description:</b> Unshielded, Cable, M12, 8-pin, angled connector female with molded cable, 2 m, PUR halogen free</li> </ul>   | DOL-1208-W02MC    | 6035623  |
|    | <ul style="list-style-type: none"> <li>• <b>Connection type head A:</b> Female connector, M12, 8-pin, angled</li> <li>• <b>Connection type head B:</b> Flying leads</li> <li>• <b>Cable:</b> 5 m, 8-wire, PVC</li> <li>• <b>Description:</b> Shielded</li> <li>• <b>Connection systems:</b> Flying leads</li> </ul>   | DOL-1208-W05MA    | 6021033  |
|   | <ul style="list-style-type: none"> <li>• <b>Connection type head A:</b> Female connector, M12, 8-pin, angled</li> <li>• <b>Connection type head B:</b> Flying leads</li> <li>• <b>Cable:</b> 5 m, 8-wire, PUR</li> <li>• <b>Description:</b> Unshielded, Cable, M12, 8-pin, angled connector female with molded cable, 5 m, PUR halogen free</li> </ul>   | DOL-1208-W05MC    | 6035624  |
|  | <ul style="list-style-type: none"> <li>• <b>Connection type head A:</b> Female connector, M12, 8-pin, angled</li> <li>• <b>Connection type head B:</b> Flying leads</li> <li>• <b>Cable:</b> 10 m, 8-wire, PUR, halogen-free</li> <li>• <b>Description:</b> Unshielded, Cable, M12, 8-pin, angled connector female with molded cable, 10 m, PUR halogen free</li> </ul>                                       | DOL-1208-W10MC    | 6035625  |

## SICK AT A GLANCE

SICK is one of the leading manufacturers of intelligent sensors and sensor solutions for industrial applications. A unique range of products and services creates the perfect basis for controlling processes securely and efficiently, protecting individuals from accidents and preventing damage to the environment.

We have extensive experience in a wide range of industries and understand their processes and requirements. With intelligent sensors, we can deliver exactly what our customers need. In application centers in Europe, Asia and North America, system solutions are tested and optimized in accordance with customer specifications. All this makes us a reliable supplier and development partner.

Comprehensive services complete our offering: SICK LifeTime Services provide support throughout the machine life cycle and ensure safety and productivity.

For us, that is “Sensor Intelligence.”

## WORLDWIDE PRESENCE:

Contacts and other locations –[www.sick.com](http://www.sick.com)