



DSL-1205-G02MC

**SICK**  
Sensor Intelligence.



## Ordering information

Type	Part no.
DSL-1205-G02MC	6025931

Other models and accessories → [www.sick.com/](http://www.sick.com/)

## Detailed technical data

### Technical specifications

<b>Accessory group</b>	Plug connectors and cables				
<b>Accessory family</b>	Connection cables				
<b>Connection type head A</b>	Female connector, M12, 5-pin, straight, A-coded				
<b>Connection type head B</b>	Male connector, M12, 5-pin, straight, A-coded				
<b>Connector material</b>	TPU				
<b>Connector color</b>	Black				
<b>Locking nut material</b>	Zinc die-cast, nickel-plated				
<b>Tightening torque</b>	0.4 Nm				
<b>Cable</b>	2 m, 5-wire, PUR, halogen-free				
<b>Jacket material</b>	PUR, halogen-free				
<b>Jacket color</b>	Black				
<b>Cable diameter</b>	5 mm				
<b>Conductor cross-section</b>	0.34 mm <sup>2</sup>				
<b>Shielding</b>	Unshielded				
<b>Bending radius</b>	<table border="0"> <tr> <td style="padding-right: 20px;">Flexible use</td> <td>&gt; 10 x cable diameter</td> </tr> <tr> <td>Stationary position</td> <td>&gt; 5 x cable diameter</td> </tr> </table>	Flexible use	> 10 x cable diameter	Stationary position	> 5 x cable diameter
Flexible use	> 10 x cable diameter				
Stationary position	> 5 x cable diameter				
<b>Bending cycles</b>	≥ 4,000,000				
<b>Reference voltage</b>	≤ 60 V				
<b>Current loading</b>	4 A				
<b>Traversing speed</b>	3 m/s				
<b>Travelling distance</b>	10 m				
<b>Acceleration</b>	≤ 10 m/s <sup>2</sup>				
<b>Signal type</b>	Digital I/Os				
<b>Application</b>	Zones with oils and lubricants Drag chain operation				
<b>Authorizations</b>	UL				
<b>UL File No.</b>	CYJV.E335179				
<b>Enclosure rating</b>	IP65/ IP67/ IP68				
<b>Ambient operating temperature</b>					

Flexible use	-25 °C ... +80 °C
Stationary position	-40 °C ... +80 °C
Head	-25 °C ... +90 °C

Classifications

<b>ECl@ss 5.0</b>	19030312
<b>ECl@ss 5.1.4</b>	19030312
<b>ECl@ss 6.0</b>	27060304
<b>ECl@ss 6.2</b>	27060304
<b>ECl@ss 7.0</b>	27060304
<b>ECl@ss 8.0</b>	27060304
<b>ECl@ss 8.1</b>	27060304
<b>ECl@ss 9.0</b>	27060304
<b>ECl@ss 10.0</b>	27060304
<b>ECl@ss 11.0</b>	27060304
<b>ETIM 5.0</b>	EC000830
<b>ETIM 6.0</b>	EC000830
<b>ETIM 7.0</b>	EC003249
<b>UNSPSC 16.0901</b>	26121604

Dimensional drawing (Dimensions in mm (inch))

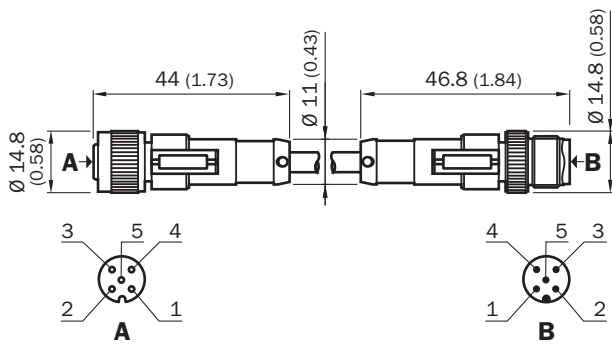

- ① brn
- ② wht
- ③ blu
- ④ blk
- ⑤ gra

## SICK AT A GLANCE

SICK is one of the leading manufacturers of intelligent sensors and sensor solutions for industrial applications. A unique range of products and services creates the perfect basis for controlling processes securely and efficiently, protecting individuals from accidents and preventing damage to the environment.

We have extensive experience in a wide range of industries and understand their processes and requirements. With intelligent sensors, we can deliver exactly what our customers need. In application centers in Europe, Asia and North America, system solutions are tested and optimized in accordance with customer specifications. All this makes us a reliable supplier and development partner.

Comprehensive services complete our offering: SICK LifeTime Services provide support throughout the machine life cycle and ensure safety and productivity.

For us, that is “Sensor Intelligence.”

## WORLDWIDE PRESENCE:

Contacts and other locations –[www.sick.com](http://www.sick.com)