



# AFS60A-BEEB262144

AFS/AFM60 Ethernet

**ABSOLUTE ENCODERS**

**SICK**  
Sensor Intelligence.



Illustration may differ



### Ordering information

Type	Part no.
AFS60A-BEEB262144	1059067

Other models and accessories → [www.sick.com/AFS\\_AFM60\\_Ethernet](http://www.sick.com/AFS_AFM60_Ethernet)

### Detailed technical data

#### Performance

<b>Number of steps per revolution (max. resolution)</b>	262,144 (18 bit)
<b>Error limits G</b>	0.03° <sup>1)</sup>
<b>Repeatability standard deviation <math>\sigma_r</math></b>	0.002° <sup>2)</sup>

<sup>1)</sup> In accordance with DIN ISO 1319-1, position of the upper and lower error limit depends on the installation situation, specified value refers to a symmetrical position, i.e. deviation in upper and lower direction is the same.

<sup>2)</sup> In accordance with DIN ISO 55350-13; 68.3% of the measured values are inside the specified area.

#### Interfaces

<b>Communication interface</b>	EtherCAT®
<b>Communication Interface detail</b>	CoE (CAN over EtherCAT®)
<b>Encoder profile</b>	CiA DS-406
<b>Data transmission rate (baud rate)</b>	10 Mbit/s, 100 Mbit/s
<b>Transmission medium</b>	CAT-5e cable
<b>Initialization time</b>	6 s
<b>Cycle time</b>	125 µs ... 100 ms
<b>Parameterising data</b>	Number of steps per revolution PRESET Counting direction Sampling rate for speed calculation Unit for output of the speed value Singleturn or multiturn access mode Quicker data exchange mode
<b>Available diagnostics data</b>	Minimum and maximum temperature Maximum speed Position monitoring Power-on counter Operating hours counter power-on/motion Counter of direction changes/number of movements cw/number of movements ccw Minimum and maximum operating voltage Signal monitoring for singleturn and multiturn

## Electrical data

<b>Connection type</b>	Male connector, Female connector, 1x, 2x, M12, M12, 4-pin, 4-pin, axial, axial <sup>1) 2)</sup>
<b>Supply voltage</b>	10 ... 30 V
<b>Power consumption</b>	≤ 3 W (without load)
<b>Reverse polarity protection</b>	✓
<b>MTTFd: mean time to dangerous failure</b>	80 years (EN ISO 13849-1) <sup>3)</sup>

<sup>1)</sup> A-coded.

<sup>2)</sup> D-coded.

<sup>3)</sup> This product is a standard product and does not constitute a safety component as defined in the Machinery Directive. Calculation based on nominal load of components, average ambient temperature 40 °C, frequency of use 8760 h/a. All electronic failures are considered hazardous. For more information, see document no. 8015532.

## Mechanical data

<b>Mechanical design</b>	Blind hollow shaft
<b>Shaft diameter</b>	12 mm
<b>Weight</b>	0.2 kg
<b>Shaft material</b>	Stainless steel
<b>Flange material</b>	Zinc diecast
<b>Housing material</b>	Aluminum
<b>Start up torque</b>	0.8 Ncm (+20 °C)
<b>Operating torque</b>	0.6 Ncm (+20 °C)
<b>Permissible movement static</b>	± 0.3 mm (radial) ± 0.5 mm (axial)
<b>Permissible movement dynamic</b>	± 0.05 mm (radial) ± 0.1 mm (axial)
<b>Operating speed</b>	≤ 6,000 min <sup>-1</sup> <sup>1)</sup>
<b>Moment of inertia of the rotor</b>	40 gcm <sup>2</sup>
<b>Bearing lifetime</b>	3 x 10 <sup>9</sup> revolutions
<b>Angular acceleration</b>	≤ 500,000 rad/s <sup>2</sup>

<sup>1)</sup> Allow for self-heating of 3.3 K per 1,000 rpm when designing the operating temperature range.

## Ambient data

<b>EMC</b>	According to EN 61000-6-2 and EN 61000-6-3 <sup>1)</sup>
<b>Enclosure rating</b>	IP65, shaft side (IEC 60529) IP67, housing side (IEC 60529) <sup>2)</sup>
<b>Permissible relative humidity</b>	90 % (Condensation not permitted)
<b>Operating temperature range</b>	-40 °C ... +85 °C
<b>Storage temperature range</b>	-40 °C ... +100 °C, without package
<b>Resistance to shocks</b>	100 g, 6 ms (EN 60068-2-27)
<b>Resistance to vibration</b>	30 g, 10 Hz ... 2,000 Hz (EN 60068-2-6)

<sup>1)</sup> The EMC according to the standards quoted is achieved if screened cables are used.

<sup>2)</sup> With mating connector fitted.

## Classifications

<b>ECLASS 5.0</b>	27270502
-------------------	----------

<b>ECLASS 5.1.4</b>	27270502
<b>ECLASS 6.0</b>	27270590
<b>ECLASS 6.2</b>	27270590
<b>ECLASS 7.0</b>	27270502
<b>ECLASS 8.0</b>	27270502
<b>ECLASS 8.1</b>	27270502
<b>ECLASS 9.0</b>	27270502
<b>ECLASS 10.0</b>	27270502
<b>ECLASS 11.0</b>	27270502
<b>ECLASS 12.0</b>	27270502
<b>ETIM 5.0</b>	EC001486
<b>ETIM 6.0</b>	EC001486
<b>ETIM 7.0</b>	EC001486
<b>ETIM 8.0</b>	EC001486
<b>UNSPSC 16.0901</b>	41112113

### Dimensional drawing (Dimensions in mm (inch))

Blind hollow shaft

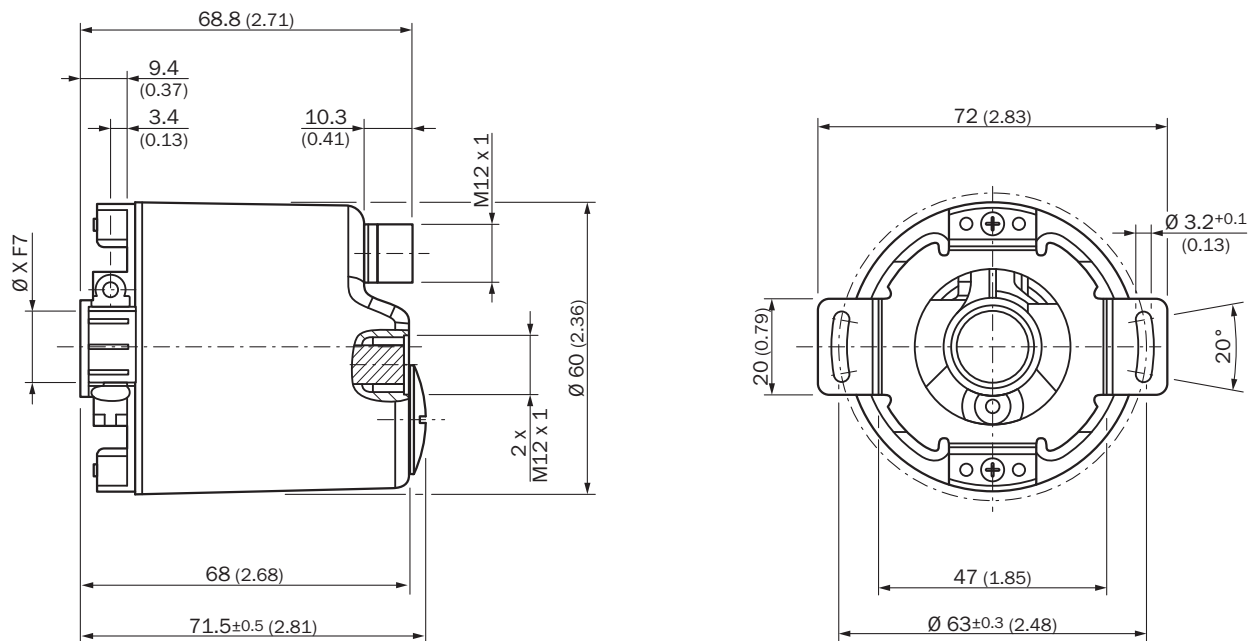

Diameter x f7 corresponds to the shaft diameter

## Attachment specifications

Blind hollow shaft

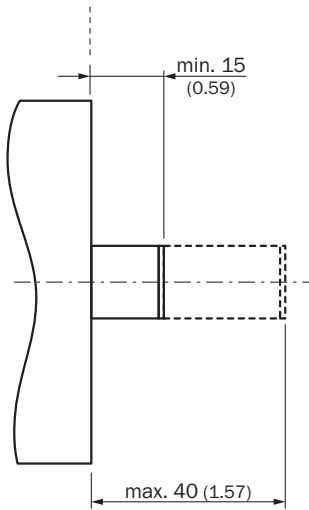

All dimensions in mm (inch)

## PIN assignment

Male connector

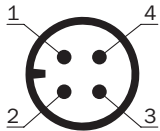

Supply voltage

PIN	Wire color	Signal
1	Brown	U <sub>S</sub> 10 V ... 30 V
2	White	Not assigned
3	Blue	GND
4	Black	Not assigned

Female connector

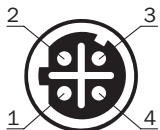

Port 1, Port 2

PIN	Wire color	Signal
1	Yellow	T x D+
2	White	R x D+
3	Orange	T x D-
4	Blue	R x D-



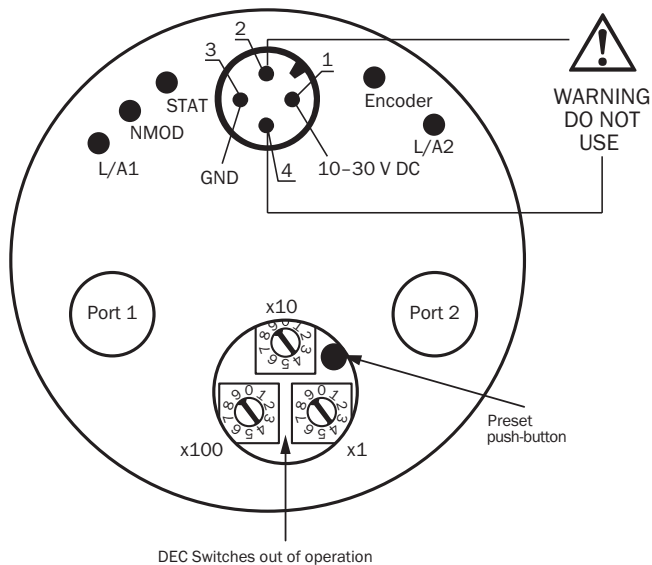



### Connection diagram



### Recommended accessories

Other models and accessories → [www.sick.com/AFS\\_AFM60\\_Ethernet](http://www.sick.com/AFS_AFM60_Ethernet)









	Brief description	Type	Part no.
<b>Flanges</b>			
	One-sided stator coupling, slot, slot radius 33 mm to 211.9 mm, slot width 5.1 mm	BEF-DS03DFS/VFS	2047431
	Flange adapter, adaptation of face mount flange with 36 mm centering hub to 50 mm servo flange, aluminum, including 3 flat head screws M4 x 10, Aluminum, including 3 countersunk screws M3 x 10	BEF-FA-036-050	2029160
	Flange adapter, adaptation of face mount flange with 36 mm centering hub to 60 mm square mounting plate, aluminum, including 3 flat head screws M4 x 8, Aluminum, including 3 countersunk screws M4 x 8	BEF-FA-036-060REC	2029162
	Flange adapter, adaptation of face mount flange with 36 mm centering hub to 58 mm square mounting plate with shock absorbers, aluminum, Aluminum	BEF-FA-036-060RSA	2029163
	Flange adapter, adaptation of face mount flange with 36 mm centering hub to 63 mm square mounting plate, aluminum, including 3 flat head screws M4 x 10, Aluminum, including 3 countersunk screws M3 x 10	BEF-FA-036-063REC	2034225
<b>Other mounting accessories</b>			
	Plastic measuring wheel with smooth plastic surface (HytreI), for 10 mm solid shaft, circumference 200 mm	BEF-MR-010020	5312988
	Measuring wheel with ridged plastic surface (HytreI) for 10 mm solid shaft, circumference 200 mm	BEF-MR-010020G	5318678

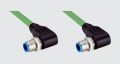
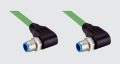



	Brief description	Type	Part no.
	Plastic measuring wheel with smooth plastic surface (Hytrel) for 10 mm solid shaft, circumference 500 mm	BEF-MR-010050	5312989
	Aluminium measuring wheel with O-ring (NBR70) for 6 mm solid shaft, circumference 200 mm	BEF-MR006020R	2055222
	Measuring wheel with O-ring (NBR70) for 6 mm solid shaft, circumference 300 mm	BEF-MR006030R	2055634
	Aluminium measuring wheel with O-ring (NBR70) for 10 mm solid shaft, circumference 200 mm	BEF-MR010020R	2055224
	Aluminium measuring wheel with O-ring (NBR70) for 10 mm solid shaft, circumference 300 mm	BEF-MR010030R	2049278
	Measuring wheel with O-ring (NBR70) for 10 mm solid shaft, circumference 500 mm	BEF-MR010050R	2055227
	O-ring for measuring wheels (circumference 200 mm)	BEF-OR-053-040	2064061
	O-ring for measuring wheels (circumference 300 mm), 2x O-ring	BEF-OR-083-050	2064076
Others			
	<ul style="list-style-type: none"> <li>• <b>Connection type head A:</b> Female connector, M12, 4-pin, angled, A-coded</li> <li>• <b>Description:</b> Unshielded, Head A: female connector, M12, 4-pin, angled, unshielded, for power supply, for cable diameter 3 mm ... 6.5 mm Head B: -</li> <li>• <b>Connection systems:</b> Screw-type terminals</li> <li>• <b>Permitted cross-section:</b> ≤ 0.75 mm<sup>2</sup></li> </ul>	DOS-1204-W	6007303
	<ul style="list-style-type: none"> <li>• <b>Connection type head A:</b> Female connector, M12, 4-pin, D-coded</li> <li>• <b>Connection type head B:</b> Female connector, RJ45, 8-pin</li> <li>• <b>Signal type:</b> Ethernet</li> <li>• <b>Cable:</b> CAT5, CAT5e</li> <li>• <b>Description:</b> Ethernet, shielded</li> <li>• <b>Note:</b> Cabinet through</li> </ul>	Feedthrough female connector Ethernet RJ45	6048180
	<ul style="list-style-type: none"> <li>• <b>Connection type head A:</b> Female connector, M12, 4-pin, straight, D-coded</li> <li>• <b>Signal type:</b> PROFINET</li> <li>• <b>Cable:</b> CAT5, CAT5e</li> <li>• <b>Description:</b> PROFINET, shielded, Head A: female connector, M12, 4-pin, straight, D-coded, shielded, PROFINET, EtherCAT, for cable diameter 4 mm ... 8 mm</li> <li>• <b>Connection systems:</b> IDC quick connection</li> <li>• <b>Permitted cross-section:</b> 0.14 mm<sup>2</sup> ... 0.34 mm<sup>2</sup></li> </ul>	DOS-1204-GZ	6048263
	<ul style="list-style-type: none"> <li>• <b>Connection type head A:</b> Female connector, M12, 4-pin, angled, D-coded</li> <li>• <b>Signal type:</b> PROFINET</li> <li>• <b>Cable:</b> CAT5, CAT5e</li> <li>• <b>Description:</b> PROFINET, shielded, Head A: female connector, M12, 4-pin, angled, D-coded, shielded, for cable diameter 4 mm ... 8 mm</li> <li>• <b>Connection systems:</b> IDC quick connection</li> <li>• <b>Permitted cross-section:</b> 0.14 mm<sup>2</sup> ... 0.34 mm<sup>2</sup></li> </ul>	DOS-1204-WZ	6048264
	<ul style="list-style-type: none"> <li>• <b>Connection type head A:</b> Male connector, M12, 4-pin, angled, D-coded</li> <li>• <b>Connection type head B:</b> Male connector, M12, 4-pin, angled, D-coded</li> <li>• <b>Signal type:</b> PROFINET</li> <li>• <b>Cable:</b> 5 m, 4-wire, CAT5, CAT5e, PUR, halogen-free</li> <li>• <b>Description:</b> PROFINET, shielded, Head A: male connector, M12, 4-pin, angled, D coded Head B: male connector, M12, 4-pin, angled, D coded Cable: PUR, halogen-free, shielded, 4 x 0.34 mm<sup>2</sup>, Ø 6.5 mm</li> </ul>	SSL-1204-W05MZ	6050636
	<ul style="list-style-type: none"> <li>• <b>Connection type head A:</b> Male connector, RJ45, 4-pin, straight</li> <li>• <b>Connection type head B:</b> Male connector, M12, 4-pin, angled, D-coded</li> <li>• <b>Signal type:</b> PROFINET, EtherCAT<sup>®</sup></li> <li>• <b>Cable:</b> 30 m, 4-wire, CAT5, CAT5e, PVC</li> <li>• <b>Description:</b> PROFINET, EtherCAT<sup>®</sup>, shielded</li> </ul>	SSL-2J04-F30MZ	6059450

	Brief description	Type	Part no.
	<ul style="list-style-type: none"> <li>• <b>Connection type head A:</b> Male connector, M12, 4-pin, straight, D-coded</li> <li>• <b>Connection type head B:</b> Male connector, RJ45, 4-pin, straight</li> <li>• <b>Signal type:</b> PROFINET</li> <li>• <b>Cable:</b> 5 m, 4-wire, CAT5, CAT5e, PVC</li> <li>• <b>Description:</b> PROFINET, shielded, Head A: male connector, M12, 4-pin, straight, D coded Head B: male connector, RJ45, 4-pin, straight Cable: PVC, shielded, 4 x 0.34 mm<sup>2</sup>, Ø 6.5 mm</li> </ul>	SSL-2J04-G05MZ60	6048245
	<ul style="list-style-type: none"> <li>• <b>Connection type head A:</b> Male connector, RJ45, 4-pin, straight</li> <li>• <b>Signal type:</b> Ethernet, PROFINET</li> <li>• <b>Cable:</b> CAT5, CAT5e</li> <li>• <b>Description:</b> Ethernet, PROFINET, shielded, Head A: male connector, RJ45, 4-pin, straight, shielded, PROFINET, EtherCAT, for cable diameter 4.5 mm ... 8 mm</li> <li>• <b>Connection systems:</b> IDC quick connection</li> <li>• <b>Permitted cross-section:</b> 4 mm<sup>2</sup> ... 8 mm<sup>2</sup></li> </ul>	STE-0J04-GZ	6048260
	<ul style="list-style-type: none"> <li>• <b>Connection type head A:</b> Male connector, M12, 4-pin, straight, D-coded</li> <li>• <b>Signal type:</b> PROFINET</li> <li>• <b>Cable:</b> CAT5, CAT5e</li> <li>• <b>Description:</b> PROFINET, shielded, Head A: male connector, M12, 4-pin, straight, D coded, shielded, for cable diameter 4 mm ... 8 mm</li> <li>• <b>Connection systems:</b> IDC quick connection</li> <li>• <b>Permitted cross-section:</b> 0.14 mm<sup>2</sup> ... 0.34 mm<sup>2</sup></li> </ul>	STE-1204-GZ	6048261
	<ul style="list-style-type: none"> <li>• <b>Connection type head A:</b> Male connector, M12, 4-pin, angled, D-coded</li> <li>• <b>Signal type:</b> PROFINET</li> <li>• <b>Cable:</b> CAT5, CAT5e</li> <li>• <b>Description:</b> PROFINET, shielded, Head A: male connector, M12, 4-pin, angled, D coded, shielded, for cable diameter 4 mm ... 8 mm</li> <li>• <b>Connection systems:</b> IDC quick connection</li> <li>• <b>Permitted cross-section:</b> 0.14 mm<sup>2</sup> ... 0.34 mm<sup>2</sup></li> </ul>	STE-1204-WZ	6048262
	<ul style="list-style-type: none"> <li>• <b>Connection type head A:</b> Female connector, M12, 4-pin, straight, A-coded</li> <li>• <b>Connection type head B:</b> Flying leads</li> <li>• <b>Signal type:</b> Sensor/actuator cable</li> <li>• <b>Cable:</b> 2 m, 4-wire, PUR, halogen-free</li> <li>• <b>Description:</b> Sensor/actuator cable, unshielded</li> <li>• <b>Application:</b> Zones with oils and lubricants, Drag chain operation, Robot</li> </ul>	YF2A14-020UB3XLEAX	2095607
	<ul style="list-style-type: none"> <li>• <b>Connection type head A:</b> Female connector, M12, 4-pin, straight, A-coded</li> <li>• <b>Connection type head B:</b> Flying leads</li> <li>• <b>Signal type:</b> Sensor/actuator cable</li> <li>• <b>Cable:</b> 5 m, 4-wire, PUR, halogen-free</li> <li>• <b>Description:</b> Sensor/actuator cable, unshielded</li> <li>• <b>Application:</b> Zones with oils and lubricants, Drag chain operation, Robot</li> </ul>	YF2A14-050UB3XLEAX	2095608
	<ul style="list-style-type: none"> <li>• <b>Connection type head A:</b> Female connector, M12, 4-pin, straight, A-coded</li> <li>• <b>Connection type head B:</b> Flying leads</li> <li>• <b>Signal type:</b> Sensor/actuator cable</li> <li>• <b>Cable:</b> 10 m, 4-wire, PUR, halogen-free</li> <li>• <b>Description:</b> Sensor/actuator cable, unshielded</li> <li>• <b>Application:</b> Zones with oils and lubricants, Drag chain operation, Robot</li> </ul>	YF2A14-100UB3XLEAX	2095609
	<ul style="list-style-type: none"> <li>• <b>Connection type head A:</b> Female connector, M12, 4-pin, straight, A-coded</li> <li>• <b>Connection type head B:</b> Flying leads</li> <li>• <b>Signal type:</b> Sensor/actuator cable</li> <li>• <b>Cable:</b> 25 m, 4-wire, PUR, halogen-free</li> <li>• <b>Description:</b> Sensor/actuator cable, unshielded</li> <li>• <b>Application:</b> Zones with oils and lubricants, Drag chain operation, Robot</li> </ul>	YF2A14-250UB3XLEAX	2095615
	<ul style="list-style-type: none"> <li>• <b>Connection type head A:</b> Female connector, M12, 4-pin, angled, A-coded</li> <li>• <b>Connection type head B:</b> Flying leads</li> <li>• <b>Signal type:</b> Sensor/actuator cable</li> <li>• <b>Cable:</b> 2 m, 4-wire, PUR, halogen-free</li> <li>• <b>Description:</b> Sensor/actuator cable, unshielded</li> <li>• <b>Application:</b> Zones with oils and lubricants, Drag chain operation, Robot</li> </ul>	YG2A14-020UB3XLEAX	2095766

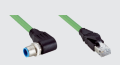

	Brief description	Type	Part no.
	<ul style="list-style-type: none"> <li>• <b>Connection type head A:</b> Female connector, M12, 4-pin, angled, A-coded</li> <li>• <b>Connection type head B:</b> Flying leads</li> <li>• <b>Signal type:</b> Sensor/actuator cable</li> <li>• <b>Cable:</b> 5 m, 4-wire, PUR, halogen-free</li> <li>• <b>Description:</b> Sensor/actuator cable, unshielded</li> <li>• <b>Application:</b> Zones with oils and lubricants, Drag chain operation, Robot</li> </ul>	YG2A14-050UB3XLEAX	2095767
	<ul style="list-style-type: none"> <li>• <b>Connection type head A:</b> Female connector, M12, 4-pin, angled, A-coded</li> <li>• <b>Connection type head B:</b> Flying leads</li> <li>• <b>Signal type:</b> Sensor/actuator cable</li> <li>• <b>Cable:</b> 10 m, 4-wire, PUR, halogen-free</li> <li>• <b>Description:</b> Sensor/actuator cable, unshielded</li> <li>• <b>Application:</b> Zones with oils and lubricants, Drag chain operation, Robot</li> </ul>	YG2A14-100UB3XLEAX	2095768
	<ul style="list-style-type: none"> <li>• <b>Connection type head A:</b> Female connector, M12, 4-pin, angled, A-coded</li> <li>• <b>Connection type head B:</b> Flying leads</li> <li>• <b>Signal type:</b> Sensor/actuator cable</li> <li>• <b>Cable:</b> 25 m, 4-wire, PUR, halogen-free</li> <li>• <b>Description:</b> Sensor/actuator cable, unshielded</li> <li>• <b>Application:</b> Zones with oils and lubricants, Drag chain operation, Robot</li> </ul>	YG2A14-250UB3XLEAX	2095771
	<ul style="list-style-type: none"> <li>• <b>Connection type head A:</b> Male connector, M12, 4-pin, angled, D-coded</li> <li>• <b>Connection type head B:</b> Flying leads</li> <li>• <b>Signal type:</b> Ethernet, PROFINET</li> <li>• <b>Cable:</b> 25 m, 4-wire, PUR, halogen-free</li> <li>• <b>Description:</b> Ethernet, PROFINET, shielded</li> <li>• <b>Application:</b> Drag chain operation, Zones with oils and lubricants</li> </ul>	YN2D24-250PN1XLEAX	2106180
	<ul style="list-style-type: none"> <li>• <b>Connection type head A:</b> Male connector, M12, 4-pin, angled, D-coded</li> <li>• <b>Connection type head B:</b> Flying leads</li> <li>• <b>Signal type:</b> Ethernet, PROFINET</li> <li>• <b>Cable:</b> 10 m, 4-wire, PUR, halogen-free</li> <li>• <b>Description:</b> Ethernet, PROFINET, shielded</li> <li>• <b>Application:</b> Drag chain operation, Zones with oils and lubricants</li> </ul>	YN2D24-100PN1XLEAX	2106176
	<ul style="list-style-type: none"> <li>• <b>Connection type head A:</b> Male connector, M12, 4-pin, angled, D-coded</li> <li>• <b>Connection type head B:</b> Flying leads</li> <li>• <b>Signal type:</b> Ethernet, PROFINET</li> <li>• <b>Cable:</b> 5 m, 4-wire, PUR, halogen-free</li> <li>• <b>Description:</b> Ethernet, PROFINET, shielded</li> <li>• <b>Application:</b> Drag chain operation, Zones with oils and lubricants</li> </ul>	YN2D24-050PN1XLEAX	2106175
	<ul style="list-style-type: none"> <li>• <b>Connection type head A:</b> Male connector, M12, 4-pin, angled, D-coded</li> <li>• <b>Connection type head B:</b> Flying leads</li> <li>• <b>Signal type:</b> Ethernet, PROFINET</li> <li>• <b>Cable:</b> 2 m, 4-wire, PUR, halogen-free</li> <li>• <b>Description:</b> Ethernet, PROFINET, shielded</li> <li>• <b>Application:</b> Drag chain operation, Zones with oils and lubricants</li> </ul>	YN2D24-020PN1XLEAX	2106174
	<ul style="list-style-type: none"> <li>• <b>Connection type head A:</b> Male connector, M12, 4-pin, straight, D-coded</li> <li>• <b>Connection type head B:</b> Flying leads</li> <li>• <b>Signal type:</b> Ethernet, PROFINET</li> <li>• <b>Cable:</b> 10 m, 4-wire, PUR, halogen-free</li> <li>• <b>Description:</b> Ethernet, PROFINET, shielded</li> <li>• <b>Application:</b> Drag chain operation, Zones with oils and lubricants</li> </ul>	YM2D24-100PN1XLEAX	2106173
	<ul style="list-style-type: none"> <li>• <b>Connection type head A:</b> Male connector, M12, 4-pin, straight, D-coded</li> <li>• <b>Connection type head B:</b> Flying leads</li> <li>• <b>Signal type:</b> Ethernet, PROFINET</li> <li>• <b>Cable:</b> 5 m, 4-wire, PUR, halogen-free</li> <li>• <b>Description:</b> Ethernet, PROFINET, shielded</li> <li>• <b>Application:</b> Drag chain operation, Zones with oils and lubricants</li> </ul>	YM2D24-050PN1XLEAX	2106172
	<ul style="list-style-type: none"> <li>• <b>Connection type head A:</b> Male connector, M12, 4-pin, straight, D-coded</li> <li>• <b>Connection type head B:</b> Flying leads</li> <li>• <b>Signal type:</b> Ethernet, PROFINET</li> <li>• <b>Cable:</b> 2 m, 4-wire, PUR, halogen-free</li> <li>• <b>Description:</b> Ethernet, PROFINET, shielded</li> <li>• <b>Application:</b> Drag chain operation, Zones with oils and lubricants</li> </ul>	YM2D24-020PN1XLEAX	2106171

	Brief description	Type	Part no.
	<ul style="list-style-type: none"> <li>• <b>Connection type head A:</b> Male connector, M12, 4-pin, angled, D-coded</li> <li>• <b>Connection type head B:</b> Male connector, M12, 4-pin, angled, D-coded</li> <li>• <b>Signal type:</b> Ethernet, PROFINET</li> <li>• <b>Cable:</b> 10 m, 4-wire, PUR, halogen-free</li> <li>• <b>Description:</b> Ethernet, PROFINET, shielded</li> <li>• <b>Application:</b> Drag chain operation, Zones with oils and lubricants</li> </ul>	YN2D24-100PN1N2D24	2106170
	<ul style="list-style-type: none"> <li>• <b>Connection type head A:</b> Male connector, M12, 4-pin, angled, D-coded</li> <li>• <b>Connection type head B:</b> Male connector, M12, 4-pin, angled, D-coded</li> <li>• <b>Signal type:</b> Ethernet, PROFINET</li> <li>• <b>Cable:</b> 2 m, 4-wire, PUR, halogen-free</li> <li>• <b>Description:</b> Ethernet, PROFINET, shielded</li> <li>• <b>Application:</b> Drag chain operation, Zones with oils and lubricants</li> </ul>	YN2D24-020PN1N2D24	2106168
	<ul style="list-style-type: none"> <li>• <b>Connection type head A:</b> Male connector, M12, 4-pin, straight, D-coded</li> <li>• <b>Connection type head B:</b> Male connector, M12, 4-pin, straight, D-coded</li> <li>• <b>Signal type:</b> Ethernet, PROFINET</li> <li>• <b>Cable:</b> 10 m, 4-wire, PUR, halogen-free</li> <li>• <b>Description:</b> Ethernet, PROFINET, shielded</li> <li>• <b>Application:</b> Drag chain operation, Zones with oils and lubricants</li> </ul>	YM2D24-100PN1M2D24	2106161
	<ul style="list-style-type: none"> <li>• <b>Connection type head A:</b> Male connector, M12, 4-pin, straight, D-coded</li> <li>• <b>Connection type head B:</b> Male connector, M12, 4-pin, straight, D-coded</li> <li>• <b>Signal type:</b> Ethernet, PROFINET</li> <li>• <b>Cable:</b> 2 m, 4-wire, PUR, halogen-free</li> <li>• <b>Description:</b> Ethernet, PROFINET, shielded</li> <li>• <b>Application:</b> Drag chain operation, Zones with oils and lubricants</li> </ul>	YM2D24-020PN1M2D24	2106159
	<ul style="list-style-type: none"> <li>• <b>Connection type head A:</b> Male connector, M12, 4-pin, straight, D-coded</li> <li>• <b>Connection type head B:</b> Male connector, M12, 4-pin, angled, D-coded</li> <li>• <b>Signal type:</b> Ethernet, PROFINET</li> <li>• <b>Cable:</b> 10 m, 4-wire, PUR, halogen-free</li> <li>• <b>Description:</b> Ethernet, PROFINET, shielded</li> <li>• <b>Application:</b> Drag chain operation, Zones with oils and lubricants</li> </ul>	YM2D24-100PN1N2D24	2106167
	<ul style="list-style-type: none"> <li>• <b>Connection type head A:</b> Male connector, M12, 4-pin, straight, D-coded</li> <li>• <b>Connection type head B:</b> Male connector, M12, 4-pin, angled, D-coded</li> <li>• <b>Signal type:</b> Ethernet, PROFINET</li> <li>• <b>Cable:</b> 5 m, 4-wire, PUR, halogen-free</li> <li>• <b>Description:</b> Ethernet, PROFINET, shielded</li> <li>• <b>Application:</b> Drag chain operation, Zones with oils and lubricants</li> </ul>	YM2D24-050PN1N2D24	2106166
	<ul style="list-style-type: none"> <li>• <b>Connection type head A:</b> Male connector, M12, 4-pin, straight, D-coded</li> <li>• <b>Connection type head B:</b> Male connector, M12, 4-pin, angled, D-coded</li> <li>• <b>Signal type:</b> Ethernet, PROFINET</li> <li>• <b>Cable:</b> 2 m, 4-wire, PUR, halogen-free</li> <li>• <b>Description:</b> Ethernet, PROFINET, shielded</li> <li>• <b>Application:</b> Drag chain operation, Zones with oils and lubricants</li> </ul>	YM2D24-020PN1N2D24	2106165
	<ul style="list-style-type: none"> <li>• <b>Connection type head A:</b> Male connector, M12, 4-pin, straight, D-coded</li> <li>• <b>Connection type head B:</b> Male connector, RJ45, 4-pin, straight</li> <li>• <b>Signal type:</b> Ethernet, PROFINET</li> <li>• <b>Cable:</b> 2 m, 4-wire, PUR, halogen-free</li> <li>• <b>Description:</b> Ethernet, PROFINET, shielded</li> <li>• <b>Application:</b> Drag chain operation, Zones with oils and lubricants</li> </ul>	YM2D24-020PN1MRJA4	2106182
	<ul style="list-style-type: none"> <li>• <b>Connection type head A:</b> Male connector, M12, 4-pin, straight, D-coded</li> <li>• <b>Connection type head B:</b> Male connector, RJ45, 4-pin, straight</li> <li>• <b>Signal type:</b> Ethernet, PROFINET</li> <li>• <b>Cable:</b> 10 m, 4-wire, PUR, halogen-free</li> <li>• <b>Description:</b> Ethernet, PROFINET, shielded</li> <li>• <b>Application:</b> Drag chain operation, Zones with oils and lubricants</li> </ul>	YM2D24-100PN1MRJA4	2106185
	<ul style="list-style-type: none"> <li>• <b>Connection type head A:</b> Male connector, M12, 4-pin, angled, D-coded</li> <li>• <b>Connection type head B:</b> Male connector, RJ45, 4-pin, straight</li> <li>• <b>Signal type:</b> Ethernet, PROFINET</li> <li>• <b>Cable:</b> 10 m, 4-wire, PUR, halogen-free</li> <li>• <b>Description:</b> Ethernet, PROFINET, shielded</li> <li>• <b>Application:</b> Drag chain operation, Zones with oils and lubricants</li> </ul>	YN2D24-100PN1MRJA4	2106164

	Brief description	Type	Part no.
	<ul style="list-style-type: none"> <li>• <b>Connection type head A:</b> Male connector, M12, 4-pin, angled, D-coded</li> <li>• <b>Connection type head B:</b> Male connector, RJ45, 4-pin, straight</li> <li>• <b>Signal type:</b> Ethernet, PROFINET</li> <li>• <b>Cable:</b> 5 m, 4-wire, PUR, halogen-free</li> <li>• <b>Description:</b> Ethernet, PROFINET, shielded</li> <li>• <b>Application:</b> Drag chain operation, Zones with oils and lubricants</li> </ul>	YN2D24-050PN1MRJA4	2106163
	<ul style="list-style-type: none"> <li>• <b>Connection type head A:</b> Male connector, M12, 4-pin, angled, D-coded</li> <li>• <b>Connection type head B:</b> Male connector, RJ45, 4-pin, straight</li> <li>• <b>Signal type:</b> Ethernet, PROFINET</li> <li>• <b>Cable:</b> 2 m, 4-wire, PUR, halogen-free</li> <li>• <b>Description:</b> Ethernet, PROFINET, shielded</li> <li>• <b>Application:</b> Drag chain operation, Zones with oils and lubricants</li> </ul>	YN2D24-020PN1MRJA4	2106162
	<ul style="list-style-type: none"> <li>• <b>Connection type head A:</b> Male connector, M12, 4-pin, straight, D-coded</li> <li>• <b>Connection type head B:</b> Male connector, M12, 4-pin, straight, D-coded</li> <li>• <b>Signal type:</b> Ethernet, PROFINET</li> <li>• <b>Cable:</b> 5 m, 4-wire, PUR, halogen-free</li> <li>• <b>Description:</b> Ethernet, PROFINET, shielded</li> <li>• <b>Application:</b> Drag chain operation, Zones with oils and lubricants</li> </ul>	YM2D24-050PN1M2D24	2106160
	<ul style="list-style-type: none"> <li>• <b>Connection type head A:</b> Male connector, M12, 4-pin, angled, D-coded</li> <li>• <b>Connection type head B:</b> Male connector, RJ45, 4-pin, straight</li> <li>• <b>Signal type:</b> Ethernet, PROFINET</li> <li>• <b>Cable:</b> 3 m, 4-wire, PUR, halogen-free</li> <li>• <b>Description:</b> Ethernet, PROFINET, shielded</li> <li>• <b>Application:</b> Drag chain operation, Zones with oils and lubricants</li> </ul>	YN2D24-030PN1MRJA4	2144265

## SICK AT A GLANCE

SICK is one of the leading manufacturers of intelligent sensors and sensor solutions for industrial applications. A unique range of products and services creates the perfect basis for controlling processes securely and efficiently, protecting individuals from accidents and preventing damage to the environment.

We have extensive experience in a wide range of industries and understand their processes and requirements. With intelligent sensors, we can deliver exactly what our customers need. In application centers in Europe, Asia and North America, system solutions are tested and optimized in accordance with customer specifications. All this makes us a reliable supplier and development partner.

Comprehensive services complete our offering: SICK LifeTime Services provide support throughout the machine life cycle and ensure safety and productivity.

For us, that is “Sensor Intelligence.”

## WORLDWIDE PRESENCE:

Contacts and other locations –[www.sick.com](http://www.sick.com)